

PBLS4002Y; PBLS4002V

40 V PNP BISS loadswitch

Rev. 01 — 6 December 2004

Product data sheet

1. Product profile

1.1 General description

Low V_{CEsat} PNP transistor and NPN resistor-equipped transistor in one package.

Table 1: Product overview

Type number	Package	
	Philips	JEITA
PBLS4002Y	SOT363	SC-88
PBLS4002V	SOT666	-

1.2 Features

- Low V_{CEsat} (BISS) and resistor-equipped transistor in one package
- Low 'threshold' voltage (< 1 V) compared to MOSFET
- Low drive power required
- Space-saving solution
- Reduction of component count.

1.3 Applications

- Supply line switches
- Battery charger switches
- High-side switches for LEDs, drivers and backlights
- Portable equipment.

1.4 Quick reference data

Table 2: Quick reference data

Symbol	Parameter	Conditions	Min	Typ	Max	Unit
TR1; PNP: low V_{CEsat} transistor						
V_{CEO}	collector-emitter voltage	open base	-	-	-40	V
I_C	collector-current (DC)		-	-	-500	mA
R_{CEsat}	equivalent on-resistance	$I_C = -500$ mA; $I_B = -50$ mA	-	440	700	m Ω
TR2; NPN: resistor-equipped transistor						
V_{CEO}	collector-emitter voltage	open base	-	-	50	V

PHILIPS

Table 2: Quick reference data ...continued

Symbol	Parameter	Conditions	Min	Typ	Max	Unit
I_o	output current (DC)		-	-	100	mA
R1	bias resistor 1 (input)		3.3	4.7	6.1	k Ω
R2/R1	bias resistor ratio		0.8	1	1.2	

2. Pinning information

Table 3: Discrete pinning

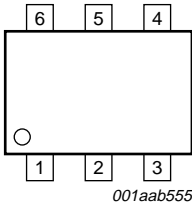
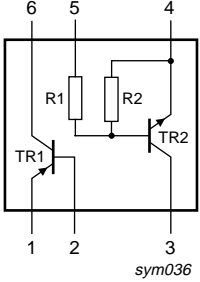
Pin	Description	Simplified outline	Symbol
1	emitter TR1	 <p>001aab555</p>	 <p>sym036</p>
2	base TR1		
3	output (collector) TR1		
4	GND (emitter) TR2		
5	input (base) TR2		
6	collector TR1		

3. Ordering information

Table 4: Ordering information

Type number	Package		
	Name	Description	Version
PBLS4002Y	SC-88	plastic surface mounted package; 6 leads	SOT363
PBLS4002V	-	plastic surface mounted package; 6 leads	SOT666

4. Marking

Table 5: Marking codes

Type number	Marking code [1]
PBLS4002Y	S2*
PBLS4002V	K2

[1] * = -: made in Hong Kong.
 * = t: made in Malaysia.
 * = W: made in China.

5. Limiting values

Table 6: Limiting values

In accordance with the Absolute Maximum Rating System (IEC 60134).

Symbol	Parameter	Conditions	Min	Max	Unit
TR1; PNP: low V_{CEsat} transistor					
V_{CBO}	collector-base voltage	open emitter	-	-40	V
V_{CEO}	collector-emitter voltage	open base	-	-40	V
V_{EBO}	emitter-base voltage	open collector	-	-6	V
I_C	collector current (DC)		-	-500	mA
I_{CM}	peak collector current	$t_p \leq 1 \text{ ms}; \delta = 0.02$	-	-1	A
I_B	base current (DC)		-	-50	mA
I_{BM}	peak base current	$t_p \leq 1 \text{ ms}; \delta = 0.02$	-	-100	mA
P_{tot}	total power dissipation	$T_{amb} \leq 25 \text{ }^\circ\text{C}$	[1]	200	mW
TR2; NPN: resistor-equipped transistor					
V_{CBO}	collector-base voltage	open emitter	-	50	V
V_{CEO}	collector-emitter voltage	open base	-	50	V
V_{EBO}	emitter-base voltage	open collector	-	10	V
V_I	input voltage				
	positive		-	+30	V
	negative		-	-10	V
I_O	output current (DC)		-	100	mA
I_{CM}	peak collector current		-	100	mA
P_{tot}	total power dissipation	$T_{amb} \leq 25 \text{ }^\circ\text{C}$	[1]	200	mW
Per device					
P_{tot}	total power dissipation		-	300	mW
T_{stg}	storage temperature		-65	+150	$^\circ\text{C}$
T_j	junction temperature		-	150	$^\circ\text{C}$
T_{amb}	ambient temperature		-65	+150	$^\circ\text{C}$

[1] Device mounted on a FR4 printed-circuit board, single-sided copper, tin-plated and standard footprint.

6. Thermal characteristics

Table 7: Thermal characteristics

Symbol	Parameter	Conditions	Min	Typ	Max	Unit
Per device						
$R_{th(j-a)}$	thermal resistance from junction to ambient	in free air				
	SOT363		[1]	-	416	K/W
	SOT666		[1][2]	-	416	K/W

[1] Device mounted on a FR4 printed-circuit board, single-sided copper, tin-plated and standard footprint.

[2] Reflow soldering is the only recommended soldering method.

7. Characteristics

Table 8: Characteristics
 $T_{amb} = 25\text{ }^{\circ}\text{C}$ unless otherwise specified.

Symbol	Parameter	Conditions	Min	Typ	Max	Unit	
TR1; PNP: low V_{CEsat} transistor							
I_{CBO}	collector-base cut-off current	$V_{CB} = -40\text{ V}; I_E = 0\text{ A}$	-	-	-100	nA	
		$V_{CB} = -40\text{ V}; I_E = 0\text{ A}; T_j = 150\text{ }^{\circ}\text{C}$	-	-	-50	μA	
I_{EBO}	emitter-base cut-off current	$V_{EB} = -5\text{ V}; I_C = 0\text{ A}$	-	-	-100	nA	
h_{FE}	DC current gain	$V_{CE} = -2\text{ V}; I_C = -10\text{ mA}$	200	-	-		
		$V_{CE} = -2\text{ V}; I_C = -100\text{ mA}$	[1]	150	-		
		$V_{CE} = -2\text{ V}; I_C = -500\text{ mA}$	[1]	40	-		
V_{CEsat}	collector-emitter saturation voltage	$I_C = -10\text{ mA}; I_B = -0.5\text{ mA}$	-	-	-50	mV	
		$I_C = -100\text{ mA}; I_B = -5\text{ mA}$	-	-	-130	mV	
		$I_C = -200\text{ mA}; I_B = -10\text{ mA}$	-	-	-200	mV	
		$I_C = -500\text{ mA}; I_B = -50\text{ mA}$	[1]	-	-350	mV	
R_{CEsat}	equivalent on-resistance	$I_C = -500\text{ mA}; I_B = -50\text{ mA}$	[1]	-	440	700	$\text{m}\Omega$
V_{BEsat}	base-emitter saturation voltage	$I_C = -500\text{ mA}; I_B = -50\text{ mA}$	[1]	-	-	-1.2	V
V_{BEon}	base-emitter turn-on voltage	$V_{CE} = -2\text{ V}; I_C = -100\text{ mA}$	[1]	-	-	-1.1	V
f_T	transition frequency	$I_C = -100\text{ mA}; V_{CE} = -5\text{ V}; f = 100\text{ MHz}$	100	300	-	MHz	
C_c	collector capacitance	$V_{CB} = -10\text{ V}; I_E = I_e = 0\text{ A}; f = 1\text{ MHz}$	-	-	10	pF	
TR2; NPN: resistor-equipped transistor							
I_{CBO}	collector-base cut-off current	$V_{CB} = 50\text{ V}; I_E = 0\text{ A}$	-	-	100	nA	
I_{CEO}	collector-emitter cut-off current	$V_{CE} = 30\text{ V}; I_B = 0\text{ A}$	-	-	1	μA	
		$V_{CE} = 30\text{ V}; I_B = 0\text{ A}; T_j = 150\text{ }^{\circ}\text{C}$	-	-	50	μA	
I_{EBO}	emitter-base cut-off current	$V_{EB} = 5\text{ V}; I_C = 0\text{ A}$	-	-	900	μA	
h_{FE}	DC current gain	$V_{CE} = 5\text{ V}; I_C = 10\text{ mA}$	30	-	-		
V_{CEsat}	collector-emitter saturation voltage	$I_C = 10\text{ mA}; I_B = 0.5\text{ mA}$	-	-	150	mV	
$V_{I(off)}$	off-state input voltage	$V_{CE} = 5\text{ V}; I_C = 100\text{ }\mu\text{A}$	-	1.1	0.5	V	
$V_{I(on)}$	on-state input voltage	$V_{CE} = 0.3\text{ V}; I_C = 20\text{ mA}$	2.5	1.9	-	V	
R1	bias resistor 1 (input)		3.3	4.7	6.1	$\text{k}\Omega$	
R2/R1	bias resistor ratio		0.8	1	1.2		
C_c	collector capacitance	$V_{CB} = 10\text{ V}; I_E = I_e = 0\text{ A}; f = 1\text{ MHz}$	-	-	2.5	pF	

[1] Pulse test: $t_p \leq 300\text{ }\mu\text{s}$; $\delta \leq 0.02$.

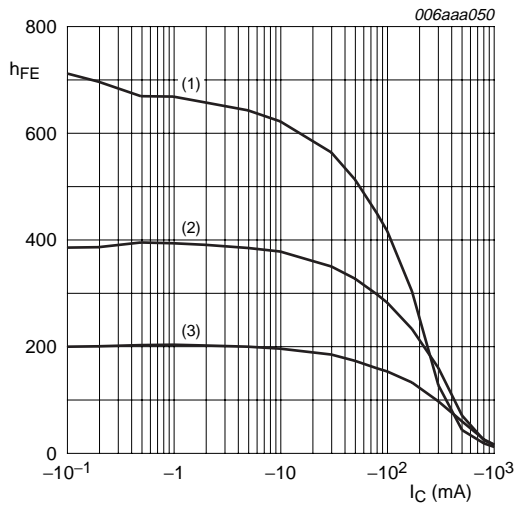

$V_{CE} = -2 \text{ V.}$

- (1) $T_{amb} = 150 \text{ }^\circ\text{C.}$
- (2) $T_{amb} = 25 \text{ }^\circ\text{C.}$
- (3) $T_{amb} = -55 \text{ }^\circ\text{C.}$

Fig 1. TR1 (PNP): DC current gain as a function of collector current; typical values.

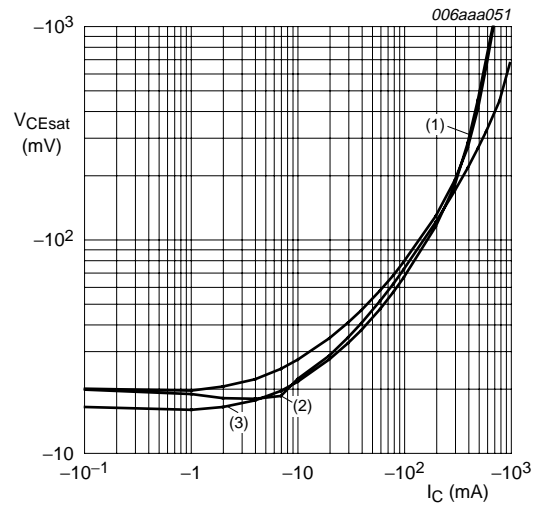

$I_C/I_B = 20.$

- (1) $T_{amb} = 150 \text{ }^\circ\text{C.}$
- (2) $T_{amb} = 25 \text{ }^\circ\text{C.}$
- (3) $T_{amb} = -55 \text{ }^\circ\text{C.}$

Fig 2. TR1 (PNP): Collector-emitter saturation voltage as a function of collector current; typical values.

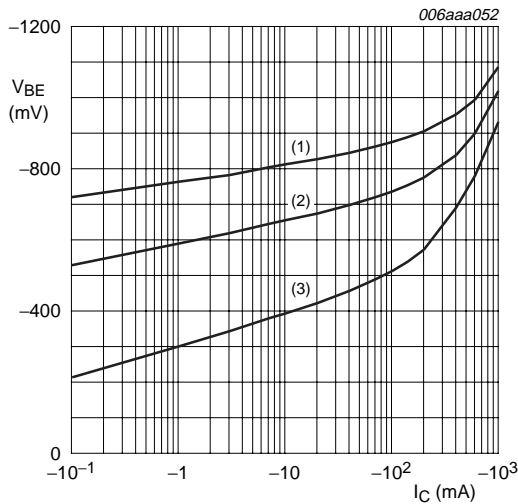

$V_{CE} = -2 \text{ V.}$

- (1) $T_{amb} = -55 \text{ }^\circ\text{C.}$
- (2) $T_{amb} = 25 \text{ }^\circ\text{C.}$
- (3) $T_{amb} = 150 \text{ }^\circ\text{C.}$

Fig 3. TR1 (PNP): Base-emitter voltage as a function of collector current; typical values.

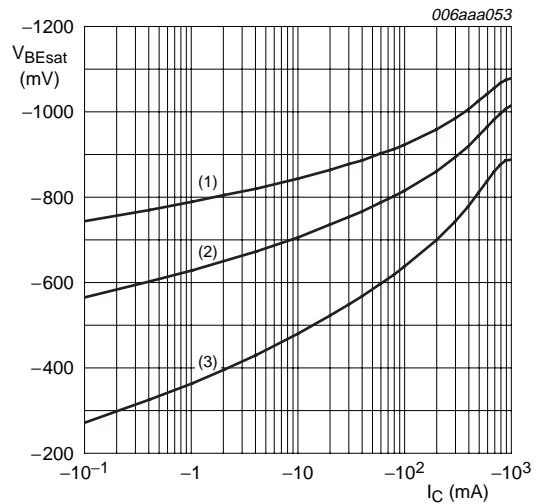

$I_C/I_B = 20.$

- (1) $T_{amb} = 150 \text{ }^\circ\text{C.}$
- (2) $T_{amb} = 25 \text{ }^\circ\text{C.}$
- (3) $T_{amb} = -55 \text{ }^\circ\text{C.}$

Fig 4. TR1 (PNP): Base-emitter saturation voltage as a function of collector current; typical values.

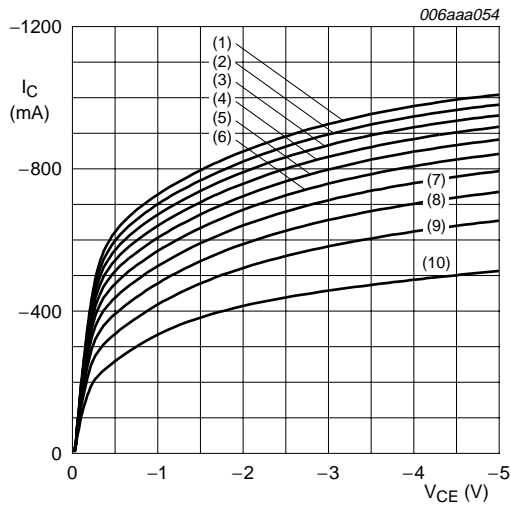

$T_{amb} = 25\text{ }^{\circ}\text{C}.$

- (1) $I_B = -40\text{ mA}$
- (2) $I_B = -36\text{ mA}$
- (3) $I_B = -32\text{ mA}$
- (4) $I_B = -28\text{ mA}$
- (5) $I_B = -24\text{ mA}$
- (6) $I_B = -20\text{ mA}$
- (7) $I_B = -16\text{ mA}$
- (8) $I_B = -12\text{ mA}$
- (9) $I_B = -8\text{ mA}$
- (10) $I_B = -4\text{ mA}.$

Fig 5. TR1 (PNP): Collector current as a function of collector-emitter voltage; typical values.

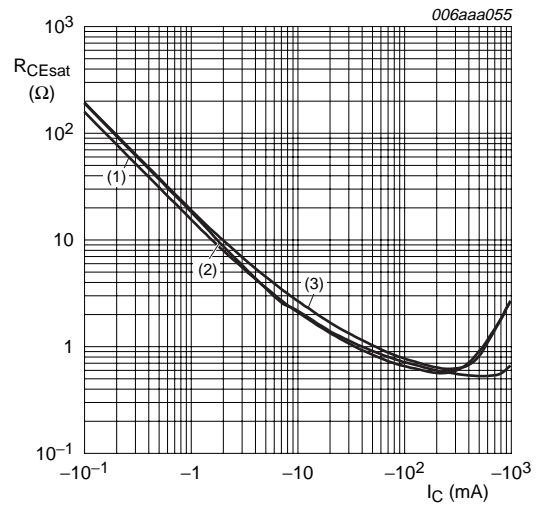

$I_C/I_B = 20.$

- (1) $T_{amb} = -55\text{ }^{\circ}\text{C}.$
- (2) $T_{amb} = 25\text{ }^{\circ}\text{C}.$
- (3) $T_{amb} = 150\text{ }^{\circ}\text{C}.$

Fig 6. TR1 (PNP): Equivalent on-resistance as a function of collector current; typical values.

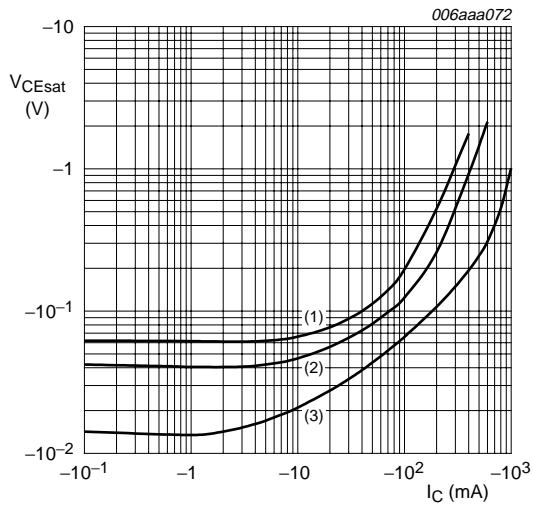

- $T_{amb} = 25\text{ }^{\circ}\text{C}.$
- (1) $I_C/I_B = 10.$
 - (2) $I_C/I_B = 50.$
 - (3) $I_C/I_B = 100.$

Fig 7. TR1 (PNP): Collector-emitter saturation voltage as a function of collector current; typical values.

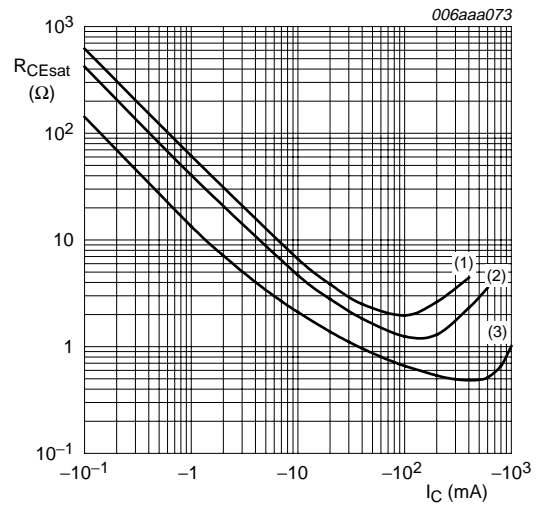

- $T_{amb} = 25\text{ }^{\circ}\text{C}.$
- (1) $I_C/I_B = 10.$
 - (2) $I_C/I_B = 50.$
 - (3) $I_C/I_B = 100.$

Fig 8. TR1 (PNP): Equivalent-on resistance as a function of collector current; typical values.

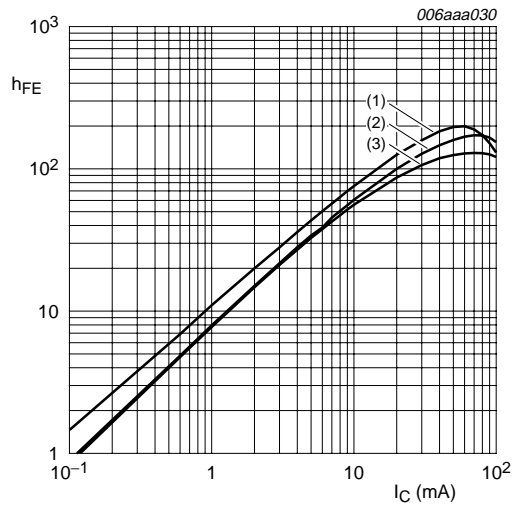

$V_{CE} = 5 \text{ V}$.

- (1) $T_{amb} = 150^\circ\text{C}$.
- (2) $T_{amb} = 25^\circ\text{C}$.
- (3) $T_{amb} = -40^\circ\text{C}$.

Fig 9. TR2 (NPN): DC current gain as a function of collector current; typical values.

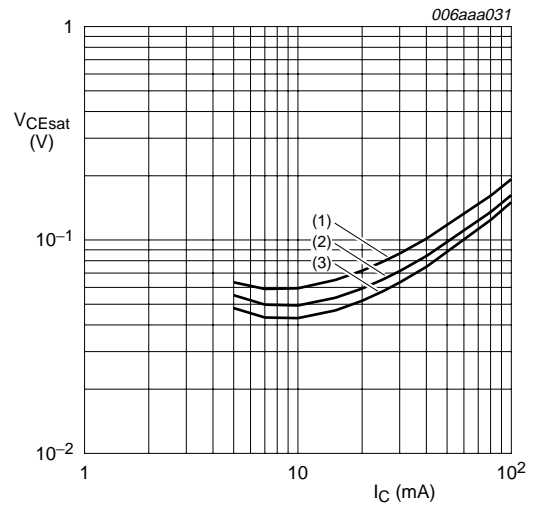

$I_C/I_B = 20$.

- (1) $T_{amb} = 100^\circ\text{C}$.
- (2) $T_{amb} = 25^\circ\text{C}$.
- (3) $T_{amb} = -40^\circ\text{C}$.

Fig 10. TR2 (NPN): Collector-emitter saturation voltage as a function of collector current; typical values.

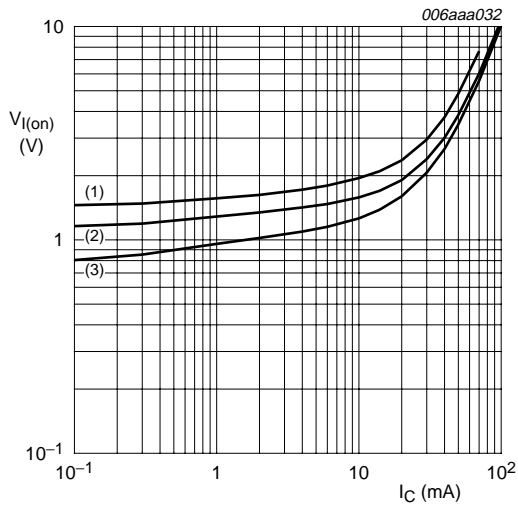

$V_{CE} = 0.3 \text{ V}$.

- (1) $T_{amb} = -40^\circ\text{C}$.
- (2) $T_{amb} = 25^\circ\text{C}$.
- (3) $T_{amb} = 100^\circ\text{C}$.

Fig 11. TR2 (NPN): On-state input voltage as a function of collector current; typical values.

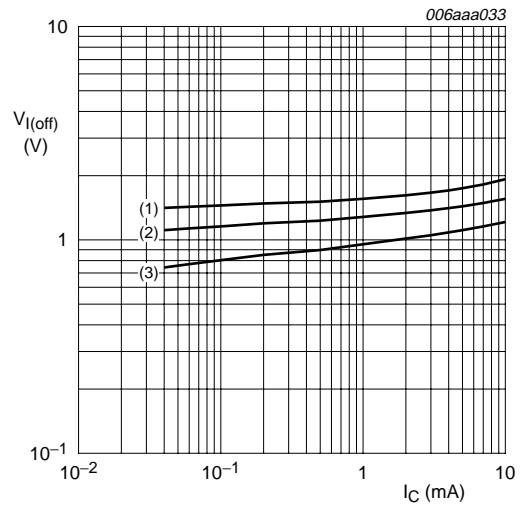

$V_{CE} = 5 \text{ V}$.

- (1) $T_{amb} = -40^\circ\text{C}$.
- (2) $T_{amb} = 25^\circ\text{C}$.
- (3) $T_{amb} = 100^\circ\text{C}$.

Fig 12. TR2 (NPN): Off-state input voltage as a function of collector current; typical values.

8. Package outline

Plastic surface mounted package; 6 leads

SOT363

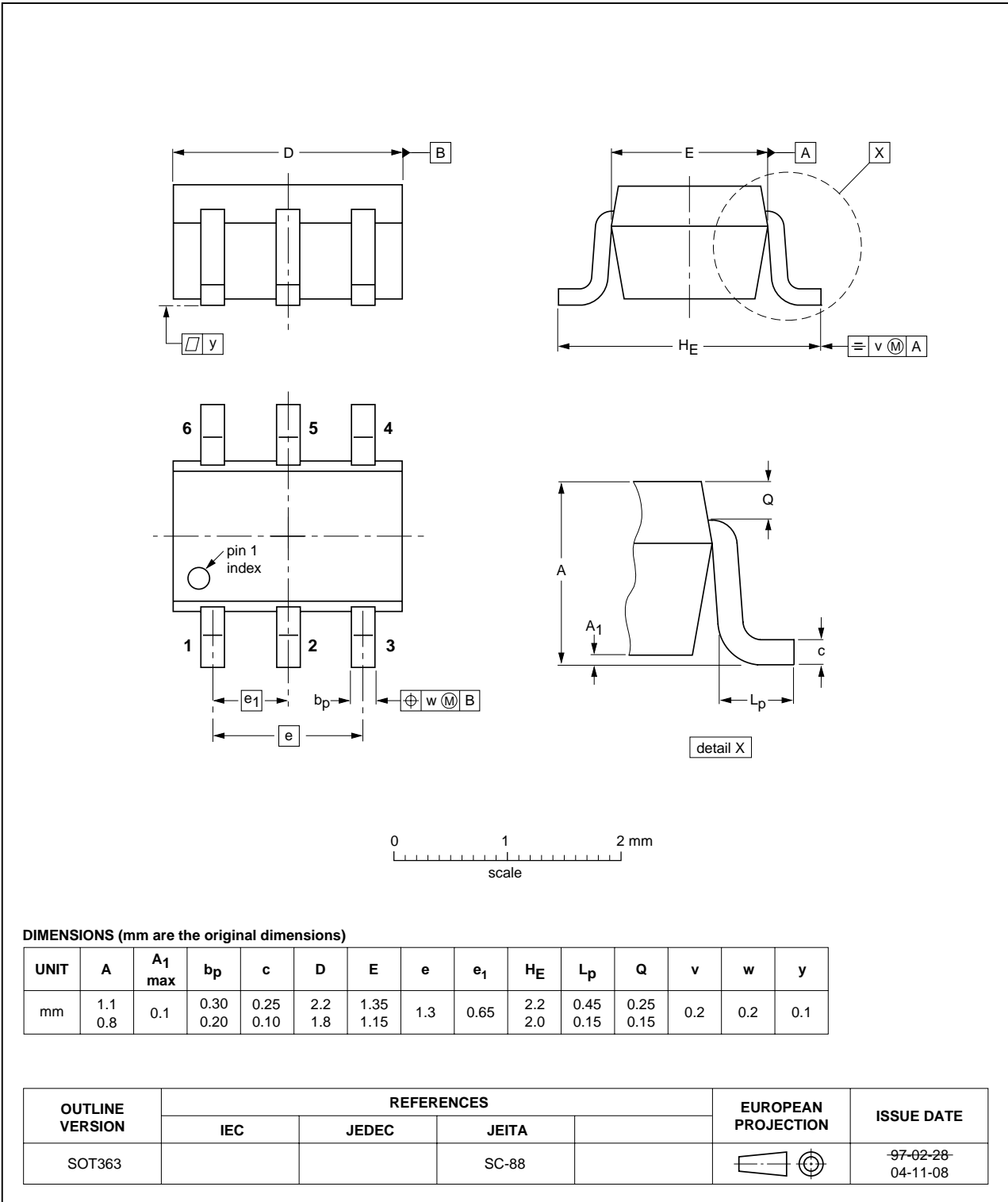

Fig 13. Package outline SOT363 (SC-88).

Plastic surface mounted package; 6 leads

SOT666

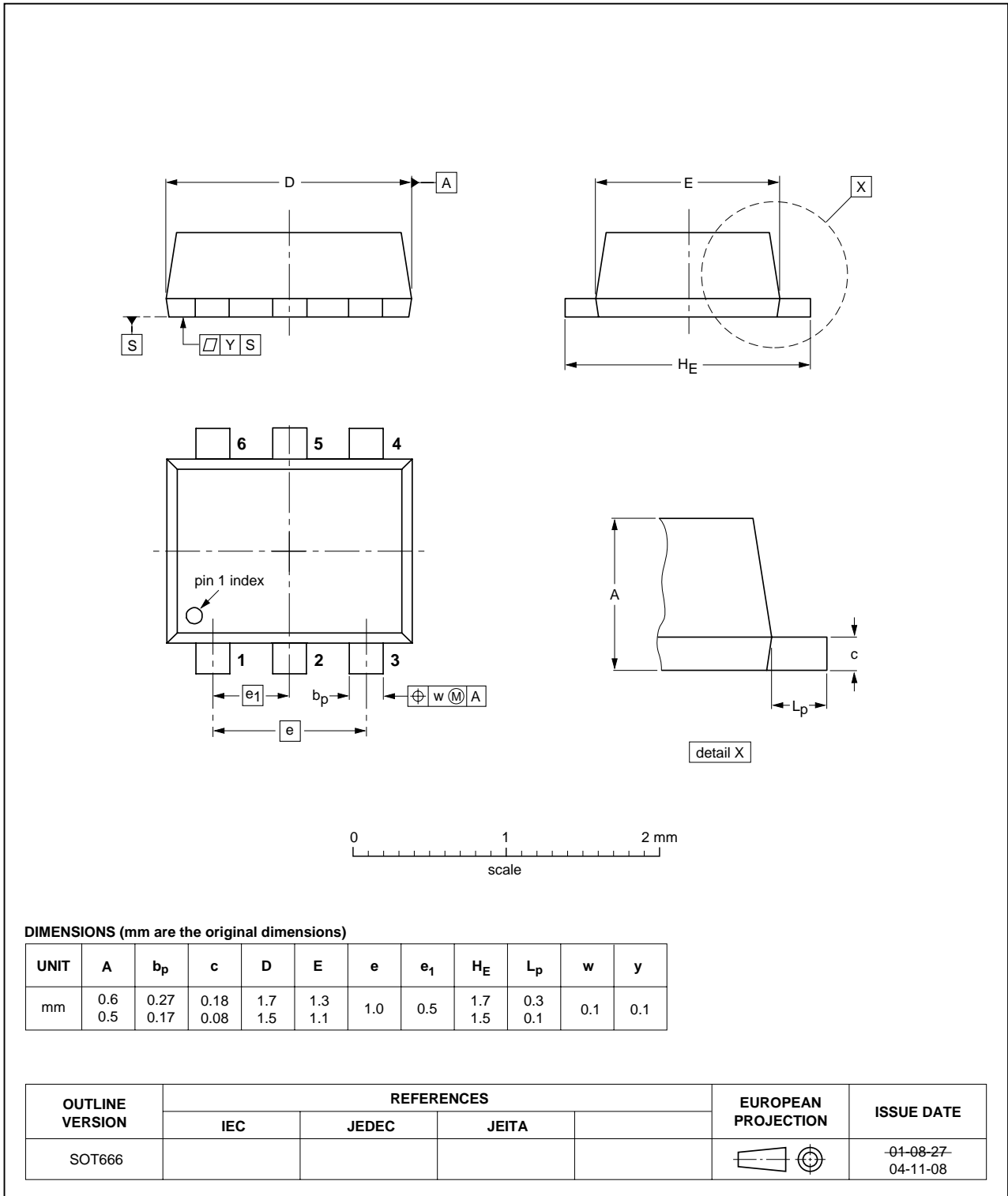

Fig 14. Package outline SOT666.

9. Packing information

Table 9: Packing methods

The indicated -xxx are the last three digits of the 12NC ordering code. [\[1\]](#)

Type number	Package	Description	Packing quantity		
			3000	4000	10000
PBL54002Y	SOT363	4 mm pitch, 8 mm tape and reel; T1	[2] -115	-	-135
		4 mm pitch, 8 mm tape and reel; T2	[3] -125	-	-165
PBL54002V	SOT666	4 mm pitch, 8 mm tape and reel	-	-115	-

[1] For further information and the availability of packing methods, see [Section 14](#).

[2] T1: normal taping.

[3] T2: reverse taping.

10. Revision history

Table 10: Revision history

Document ID	Release date	Data sheet status	Change notice	Doc. number	Supersedes
PBL54002Y_PBL54002V_1	20041206	Product data sheet	-	9397 750 13455	-

11. Data sheet status

Level	Data sheet status ^[1]	Product status ^[2] ^[3]	Definition
I	Objective data	Development	This data sheet contains data from the objective specification for product development. Philips Semiconductors reserves the right to change the specification in any manner without notice.
II	Preliminary data	Qualification	This data sheet contains data from the preliminary specification. Supplementary data will be published at a later date. Philips Semiconductors reserves the right to change the specification without notice, in order to improve the design and supply the best possible product.
III	Product data	Production	This data sheet contains data from the product specification. Philips Semiconductors reserves the right to make changes at any time in order to improve the design, manufacturing and supply. Relevant changes will be communicated via a Customer Product/Process Change Notification (CPCN).

[1] Please consult the most recently issued data sheet before initiating or completing a design.

[2] The product status of the device(s) described in this data sheet may have changed since this data sheet was published. The latest information is available on the Internet at URL <http://www.semiconductors.philips.com>.

[3] For data sheets describing multiple type numbers, the highest-level product status determines the data sheet status.

12. Definitions

Short-form specification — The data in a short-form specification is extracted from a full data sheet with the same type number and title. For detailed information see the relevant data sheet or data handbook.

Limiting values definition — Limiting values given are in accordance with the Absolute Maximum Rating System (IEC 60134). Stress above one or more of the limiting values may cause permanent damage to the device. These are stress ratings only and operation of the device at these or at any other conditions above those given in the Characteristics sections of the specification is not implied. Exposure to limiting values for extended periods may affect device reliability.

Application information — Applications that are described herein for any of these products are for illustrative purposes only. Philips Semiconductors make no representation or warranty that such applications will be suitable for the specified use without further testing or modification.

13. Disclaimers

Life support — These products are not designed for use in life support appliances, devices, or systems where malfunction of these products can reasonably be expected to result in personal injury. Philips Semiconductors customers using or selling these products for use in such applications do so at their own risk and agree to fully indemnify Philips Semiconductors for any damages resulting from such application.

Right to make changes — Philips Semiconductors reserves the right to make changes in the products - including circuits, standard cells, and/or software - described or contained herein in order to improve design and/or performance. When the product is in full production (status 'Production'), relevant changes will be communicated via a Customer Product/Process Change Notification (CPCN). Philips Semiconductors assumes no responsibility or liability for the use of any of these products, conveys no license or title under any patent, copyright, or mask work right to these products, and makes no representations or warranties that these products are free from patent, copyright, or mask work right infringement, unless otherwise specified.

14. Contact information

For additional information, please visit: <http://www.semiconductors.philips.com>

For sales office addresses, send an email to: sales.addresses@www.semiconductors.philips.com

15. Contents

1	Product profile	1
1.1	General description	1
1.2	Features	1
1.3	Applications	1
1.4	Quick reference data	1
2	Pinning information	2
3	Ordering information	2
4	Marking	2
5	Limiting values	3
6	Thermal characteristics	3
7	Characteristics	4
8	Package outline	9
9	Packing information	11
10	Revision history	12
11	Data sheet status	13
12	Definitions	13
13	Disclaimers	13
14	Contact information	13



© Koninklijke Philips Electronics N.V. 2004

All rights are reserved. Reproduction in whole or in part is prohibited without the prior written consent of the copyright owner. The information presented in this document does not form part of any quotation or contract, is believed to be accurate and reliable and may be changed without notice. No liability will be accepted by the publisher for any consequence of its use. Publication thereof does not convey nor imply any license under patent- or other industrial or intellectual property rights.

Date of release: 6 December 2004
Document order number: 9397 750 13455

Published in The Netherlands