

# Single/Double Density Floppy Disk Controller With High Performance Analog Data Separator

## FEATURES

- IBM Compatible in both Single and Double Density Recording Formats
- High Performance self tuning Analog Data Separator
- Software compatible with Industry Standard FDC 765A
- Programmable Data Record Lengths: 128, 256, 512, or 1024 Bytes/Sector
- Multi-Sector and Multi-Track Transfer Capacity
- Drive Up to 4 Floppy Disks
- Data Scan Capability - will scan a Single Sector or an entire cylinder's worth of data fields, comparing on a Byte to Byte Basis, data in the Processor's Memory with data read from the Diskette
- Data Transfer in DMA or Non-DMA Mode
- Parallel Seek Operations on up to four drives
- Compatible with Most Microprocessors
- Single Phase 16 MHz Clock
- Single +5 Volt Power Supply
- Available in 40-Pin Dual-in-Line Package
- COPLAMOS<sup>®</sup>n-Channel Silicon Gate Technology

## PIN CONFIGURATION

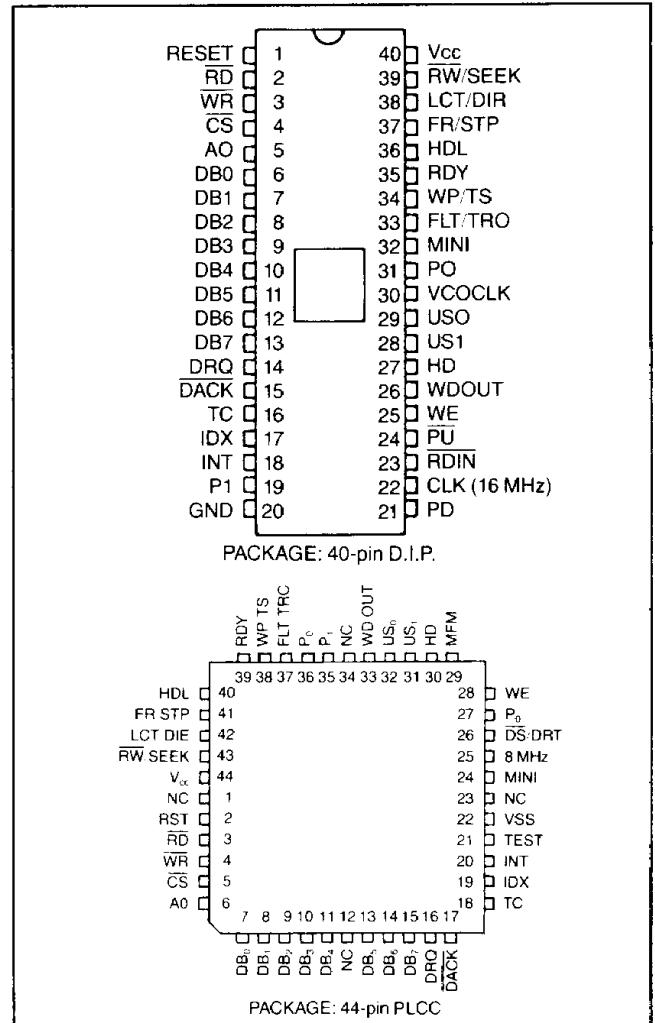

## GENERAL DESCRIPTION

The FDC 9267 is an enhanced floppy disk controller that integrates the SMC 765A Floppy Disk Controller with a high performance data separator. The controller portion contains the circuitry for interfacing a micro-processor to four floppy disk drives. The high performance, self tuning analog data separator is capable of recovering data with 2 $\mu$ s, 4 $\mu$ s and 8 $\mu$ s bit cells. This allows the device to be used in systems with 3.5", 5.25" or 8" drives that are single or double sided using FM or MFM encoding.

The FDC 9267 is 100% software compatible with the industry standard SMC FDC 765A. This ensures full diskette and system level compatibility.

The FDC 9267 provides hand-shaking signals for DMA purposes. It will operate in DMA or non-DMA mode. In non-

DMA mode an interrupt is generated each time a byte is available.

There are 15 commands the FDC 9267 is capable of performing. Each command requires multiple byte transfers to specify the operation. The following commands are available:

- |                   |                    |
|-------------------|--------------------|
| Read Data         | Write Data         |
| Read ID           | Format Track       |
| Read Deleted Data | Write Deleted Data |
| Read Track        | Seek               |
| Scan Equal        | Scan High or Equal |
| Scan Low or Equal | Sense Drive Status |
| Specify Sense     | Interrupt Status   |
| Recalibrate       |                    |

## TYPICAL APPLICATION

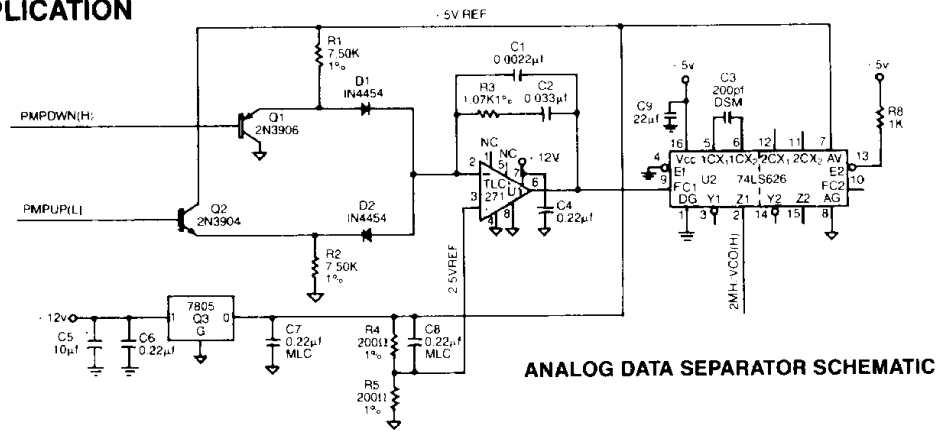

## DESCRIPTION OF PIN FUNCTIONS

PIN NO.	NAME	SYMBOL	DESCRIPTION
1	RESET	RESET	This input, when high, places the FDC 9267 into an idle state and forces the output signals to the floppy drive low. Reset does not affect SRT, HUT or HLT in Specify command. If the RDY pin is held high during reset, the FDC 9267 will generate an interrupt 1.024ms later. To clear this interrupt use the Sense Interrupt Status Command.
2	READ	$\overline{RD}$	This input, when low, allows data to transfer from the FDC 9267 to the data bus.
3	WRITE	$\overline{WR}$	This input, when low, allows data to transfer from the data bus to the FDC 9267.
4	CHIP SELECT	$\overline{CS}$	This input, when low, selects the FDC 9267 thus enabling RD and WR.
5	ADDRESS 0	A0	This input, when high, allows the data register to be read or written. When low, it allows the status register to be read.
6, 7, 8, 9, 10, 11, 12, 13	DATA BUS 0-7	DB0-7	Bi-directional 8 bit data bus.
14	DMA REQUEST	DRQ	This output, when high, indicates that the FDC 9267 is requesting a DMA transfer. To allow easier system interfacing, and to insure full compatibility, DRQ is typically active 1µs prior to the data byte being available (during disk read operations).
15	DMA ACKNOWLEDGE	$\overline{DACK}$	This input, when low, indicates to the FDC 9267 that a DMA request is being acknowledged.
16	TERMINAL COUNT	TC	When high, this input indicates the termination of a DMA, polled, or interrupt driven transfer. It terminates data transfer during READ/ WRITE/SCAN command in DMA or interrupt mode.
17	INDEX	IDX	This input, when high, informs the FDC 9267 of the beginning of the disk track.
18	INTERRUPT	INT	This output, when high, indicates the FDC 9267 is requesting an interrupt.
19	PRECOMP 1	P1	Input used to select desired precompensation value. Refer to table 6.
20	GROUND	GND	
21	PUMPDOWN	PD	This output, when high, causes the VCO frequency to decrease.
22	CLOCK	CLK	This input is a 16mhz square wave clock.
23	RAW DATA IN	$\overline{RDIN}$	This input is the raw read data from the floppy drive.
24	PUMP UP	$\overline{PU}$	This output, when low, causes the VCO frequency to increase.
25	WRITE ENABLE	WE	This output, when high, enables the floppy disk drive to write data.
26	WRITE DATA OUT	WDOUT	This output is the precompensated serial data signal to the floppy disk drive.
27	HEAD SELECT	HD	When high, this outputs selects head 1. When low, head 2 is selected.
28, 29	UNIT SELECT	US1-0	These two outputs are the encoded form of unit select 0 thru 3.
30	VCO CLOCK	VCOCLK	This input is the VCO signal from the VCO. The VCO frequency is nominally 2 mHz.
31	PRECOMP 0	PO	Input used to select desired precompensation value. Refer to table 6.
32	MINI	MINI	This input, when high, configures the FDC 9267 for operation with floppy disk data rates of 125 Kbs or 250 Kbs.

## DESCRIPTION OF PIN FUNCTIONS

PIN NO.	NAME	SYMBOL	DESCRIPTION
33	FAULT/TRACK 0	FLT/TR0	This input senses floppy disk drive fault conditions in read/write mode; and track 0 in seek mode.
34	WRITE PROTECT TWO SIDED	WP/TS	This input senses write protect status in the read/write mode; and two sided media in the seek mode.
35	READY	RDY	When high, this input indicates the floppy disk drive is ready for transfers.
36	HEAD LOAD	HDL	When high, this output causes the floppy disk read/write head to contact the disk.
37	FAULT RESET/STEP	FR/STP	When high and in the read/write mode this output will reset the fault flip flop. In the seek mode this output is used to step the head.
38	LOW CURRENT/DIRECTION	LCT/DIR	In the read/write mode, this output lowers the write current when writing on the inner tracks. In the seek mode, this output determines the direction the head will step. A fault reset pulse is issued at the beginning of each read or write command prior to the occurrence of the head load signal.
39	READ WRITE/SEEK	$\overline{RW}$ /SEEK	When this output is high the seek mode is selected. When low, the read/write mode is selected.
40	POWER	Vcc	

NOTE: For optimum performance, stray capacitance (on the printed circuit board) must be minimized between the PUMPDOWN and

the PUMPUP pins. Printed circuit board traces to these pins should be as short and as symmetrical as possible.

### DESCRIPTION OF INTERNAL REGISTERS

The FDC 9267 contains two registers which may be accessed by the main system processor; a Status Register and a Data Register. The 8-bit Main Status Register contains the status information of the FDC, and may be accessed at any time. The 8-bit Data Register (actually consists of several registers in a stack with only one register presented to the data bus at a time), which stores data, commands, parameters, and FDD status information. Data bytes are read out of, or written into, the Data Register in order to program or obtain the results after a particular command. The

Status Register may only be read and used to facilitate the transfer of data between the processor and FDC.

The relationship between the Status Data Registers and the signals  $\overline{RD}$ ,  $\overline{WR}$ , and  $A_0$  is shown below.

$A_0$	$\overline{RD}$	$\overline{WR}$	FUNCTION
0	0	1	Read Main Status Register
0	1	0	Illegal
0	0	0	Illegal
1	0	0	Illegal
1	0	1	Read from Data Register
1	1	0	Write into Data Register

The bits in the Main Status Register are defined as follows:

BIT NUMBER	NAME	SYMBOL	DESCRIPTION
DB <sub>0</sub>	FDD 0 Busy	D <sub>0</sub> B	FDD number 0 is in the Seek mode. If any of the bits are set FDC will not accept read or write command.
DB <sub>1</sub>	FDD 1 Busy	D <sub>1</sub> B	FDD number 1 is in the Seek mode. If any of the bits are set FDC will not accept read or write command.
DB <sub>2</sub>	FDD 2 Busy	D <sub>2</sub> B	FDD number 2 is in the Seek mode. If any of the bits are set FDC will not accept read or write command.
DB <sub>3</sub>	FDD 3 Busy	D <sub>3</sub> B	FDD number 3 is in the Seek mode. If any of the bits are set FCC will not accept read or write command.
DB <sub>4</sub>	FDC Busy	CB	A read or write command is in process. FDC will not accept any other command.
DB <sub>5</sub>	Execution Mode	EXM	This bit is set only during execution phase in non-DMA mode. When DB <sub>5</sub> goes low, execution phase has ended, and result phase was started. It operates only during NON-DMA mode of operation.
DB <sub>6</sub>	Data Input/Output	DIO	Indicates direction of data transfer between FDC and Data Register. If DIO = "1" then transfer is from Data Register to the Processor. If DIO = "0", then transfer is from the Processor to Data Register.
DB <sub>7</sub>	Request for Master	RQM	Indicates Data Register is ready to send or receive data to or from the Processor. Both bits DIO and RQM should be used to perform the hand-shaking functions of "ready" and "direction" to the processor.

DIO and RQM bits in the Status Register indicate when Data is ready and in which direction data will be transferred on the Data Bus. When MINI is low, the max time between the last  $\overline{RD}$  or  $\overline{WR}$  during command or result phase and DIO and RQM getting set or reset is

12 $\mu$ s. For this reason, every time Main Status Register is read the CPU should wait 12 $\mu$ s. The max time from the trailing edge of the last  $\overline{RD}$  in the phase to when DB<sub>4</sub> (FDC Busy) goes low is 12 $\mu$ s. These times must be doubled (to 24 $\mu$ s) when MINI is high.

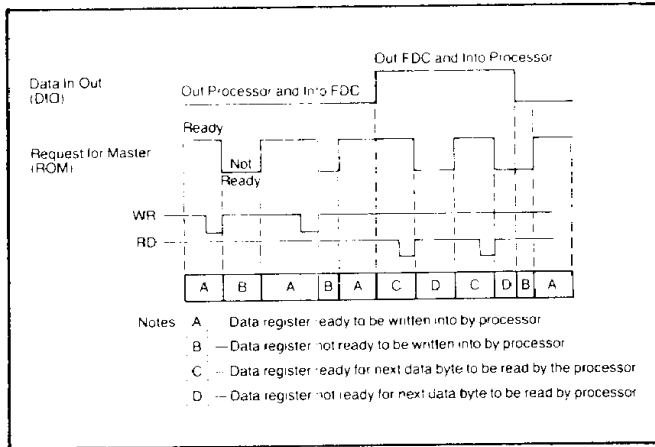

## COMMAND SEQUENCE

The FDC is capable of performing 15 different commands. Each command is initiated by a multi-byte transfer from the processor, and the result after execution of the command may also be a multi-byte transfer back to the processor. Because of this multi-byte interchange of information between the FDC and the processor, it is convenient to consider each command as consisting of three phases:

- Command Phase:** The FDC receives all information required to perform a particular operation from the processor.
- Execution Phase:** The FDC performs the operation it was instructed to do.
- Result Phase:** After completion of the operation, status and other housekeeping information are made available to the processor.

## COMMAND SYMBOL DESCRIPTION

SYMBOL	NAME	DESCRIPTION
A <sub>0</sub>	Address Line 0	A <sub>0</sub> controls selection of Main Status Register (A <sub>0</sub> = 0) or Data Register (A <sub>0</sub> = 1).
C	Cylinder Number	C stands for the current selected Cylinder (track) number 0 through 76 of the medium.
D	Data	D stands for the data pattern which is going to be written into a Sector.
D <sub>7</sub> -D <sub>0</sub>	Data Bus	8-bit Data Bus, where D <sub>7</sub> stands for a most significant bit, and D <sub>0</sub> stands for a least significant bit.
DTL	Data Length	When N is defined as 00, DTL stands for the data length which users are going to read out or write into the Sector.
EOT	End of Track	EOT stands for the final Sector number on a Cylinder. During Read or Write operation FDC will stop data transfer after a sector # equal to EOT.
GPL	Gap Length	GPL stands for the length of Gap 3. During Read/Write commands this value determines the number of bytes that VCOs will stay low after two CRC bytes. During Format command it determines the size of Gap 3.
H	Head Address	H stands for head number 0 or 1, as specified in ID field.
HD	Head	HD stands for a selected head number 0 or 1 and controls the polarity of pin 27. (H = HD in all command words.)
HLT	Head Load Time	HLT stands for the head load time in the FDD (2 to 254 ms in 2 ms increments).
HUT	Head Unload Time	HUT stands for the head unload time after a read or write operation has occurred (16 to 240 ms in 16 ms increments).
MF	FM or MFM Mode	If MF is low, FM mode is selected, and if it is high, MFM mode is selected.
MT	Multi-Track	If MT is high, a multi-track operation is to be performed. If MT = 1 after finishing Read/Write operation on side 0 FDC will automatically start searching for sector 1 on side 1.
N	Number	N stands for the number of data bytes written in a Sector.
NCN	New Cylinder Number	NCN stands for a New Cylinder Number, which is going to be reached as a result of the Seek operation. Desired position of Head.
ND	Non-DMA Mode	ND stands for operation in the Non-DMA Mode.
PCN	Present Cylinder Number	PCN stands for the Cylinder number at the completion of SENSE INTERRUPT STATUS Command. Position of Head at present time.
R	Record	R stands for the Sector number, which will be read or written.
R/W	Read/Write	R/W stands for either Read (R) or Write (W) signal.
SC	Sector	SC indicates the number of Sectors per Cylinder.
SK	Skip	SK stands for Skip Deleted Data Address Mark.
SRT	Step Rate Time	SRT stands for the Stepping Rate for the FDD. (1 to 16 ms in 1 ms increments.) Stepping Rate applies to all drives. (F = 1 ms, E = 2 ms, etc.).
ST 0 ST 1 ST 2 ST 3	Status 0 Status 1 Status 2 Status 3	ST 0-3 stand for one of four registers which store the status information after a command has been executed. This information is available during the result phase after command execution. These registers should not be confused with the main status register (selected by A <sub>0</sub> = 0). ST 0-3 may be read only after a command has been executed and contain information relevant to that particular command.
STP		During a Scan operation, if STP = 1, the data in contiguous sectors is compared byte by byte with data sent from the processor (or DMA); and if STP = 2, then alternate sectors are read and compared.
US0, US1	Unit Select	US stands for a selected drive number 0 or 1.

INSTRUCTION SET ① ②

PHASE	R/W	DATA BUS								REMARKS	PHASE	R/W	DATA BUS								REMARKS	
		D7	D6	D5	D4	D3	D2	D1	D0				D7	D6	D5	D4	D3	D2	D1	D0		
<b>READ DATA</b>																						
Command	W	MT	MF	SK	0	0	1	1	0	Command Codes	Command	W	0	MF	SK	0	0	1	0	Command Codes		
	W	X	X	X	X	X	HD	US1	US0	Sector ID information prior to Command execution. The 4 bytes are commanded against header on Floppy Disk.		W	X	X	X	X	X	HD	US1	US0	Sector ID information prior to Command execution	
	W	-----C-----										W	-----C-----									
	W	-----H-----										W	-----H-----									
	W	-----R-----										W	-----R-----									
	W	-----N-----										W	-----N-----									
	W	-----EOT-----										W	-----EOT-----									
	W	-----GPL-----										W	-----GPL-----									
	W	-----DTL-----									W	-----DTL-----										
Execution										Data transfer between the FDD and main-system	Execution										Data-transfer between the FDD and main-system. FDC reads all data fields from index hole to EOT.	
Result	R	-----ST 0-----								Status information after Command execution	Result	R	-----ST 0-----								Status information after Command execution	
	R	-----ST 1-----										R	-----ST 1-----									
	R	-----ST 2-----										R	-----ST 2-----									
	R	-----C-----									Sector ID information after Command execution		R	-----C-----								
	R	-----H-----										R	-----H-----									
	R	-----R-----										R	-----R-----									
	R	-----N-----										R	-----N-----									
<b>READ DELETED DATA</b>																						
Command	W	MT	MF	SK	0	1	1	0	0	Command Codes	Command	W	0	MF	0	0	1	0	1	0	Commands	
	W	X	X	X	X	X	HD	US1	US0	Sector ID information prior to Command execution. The 4 bytes are commanded against header on Floppy Disk.		W	X	X	X	X	X	HD	US1	US0	The first correct ID information on the Cylinder is stored in Data Register	
	W	-----C-----										W	-----C-----									
	W	-----H-----										W	-----H-----									
	W	-----R-----										W	-----R-----									
	W	-----N-----										W	-----N-----									
	W	-----EOT-----										W	-----EOT-----									
	W	-----GPL-----										W	-----GPL-----									
	W	-----DTL-----									W	-----DTL-----										
Execution										Data transfer between the FDD and main-system	Execution											
Result	R	-----ST 0-----								Status information after Command execution	Result	R	-----ST 0-----								Status information after Command execution	
	R	-----ST 1-----										R	-----ST 1-----									
	R	-----ST 2-----										R	-----ST 2-----									
	R	-----C-----									Sector ID information after Command execution		R	-----C-----								
	R	-----H-----										R	-----H-----									
	R	-----R-----										R	-----R-----									
	R	-----N-----										R	-----N-----									
<b>READ A TRACK</b>																						
Command	W	0	MF	0	0	1	0	1	0	Command Codes	Command	W	0	MF	0	0	1	0	1	0	Commands	
	W	X	X	X	X	X	HD	US1	US0	Sector ID information prior to Command execution. The 4 bytes are commanded against header on Floppy Disk.		W	X	X	X	X	X	HD	US1	US0	The first correct ID information on the Cylinder is stored in Data Register	
	W	-----C-----										W	-----C-----									
	W	-----H-----										W	-----H-----									
	W	-----R-----										W	-----R-----									
	W	-----N-----										W	-----N-----									
	W	-----EOT-----										W	-----EOT-----									
	W	-----GPL-----										W	-----GPL-----									
	W	-----DTL-----									W	-----DTL-----										
Execution										Data transfer between the FDD and main-system	Execution										The first correct ID information on the Cylinder is stored in Data Register	
Result	R	-----ST 0-----								Status information after Command execution	Result	R	-----ST 0-----								Status information after Command execution	
	R	-----ST 1-----										R	-----ST 1-----									
	R	-----ST 2-----										R	-----ST 2-----									
	R	-----C-----									Sector ID information after Command execution		R	-----C-----								
	R	-----H-----										R	-----H-----									
	R	-----R-----										R	-----R-----									
	R	-----N-----										R	-----N-----									
<b>WRITE DATA</b>																						
Command	W	MT	MF	0	0	1	0	1		Command Codes	Command	W	0	MF	0	0	1	1	0	1	Command Codes	
	W	X	X	X	X	X	HD	US1	US0	Sector ID information prior to Command execution. The 4 bytes are commanded against header on Floppy Disk.		W	X	X	X	X	X	HD	US1	US0	Bytes/Sector Sectors/Track Gap 3 Filter Byte	
	W	-----C-----										W	-----N-----									
	W	-----H-----										W	-----SC-----									
	W	-----R-----										W	-----GPL-----									
	W	-----N-----										W	-----D-----									
	W	-----EOT-----										W	-----D-----									
	W	-----GPL-----										W	-----D-----									
	W	-----DTL-----									W	-----D-----										
Execution										Data-transfer between the main-system and FDD	Execution										FDC formats an entire track	
Result	R	-----ST 0-----								Status information after Command execution	Result	R	-----ST 0-----								Status information after Command execution	
	R	-----ST 1-----										R	-----ST 1-----									
	R	-----ST 2-----										R	-----ST 2-----									
	R	-----C-----									Sector ID information after Command execution		R	-----C-----								
	R	-----H-----										R	-----H-----									
	R	-----R-----										R	-----R-----									
	R	-----N-----										R	-----N-----									
<b>WRITE DELETED DATA</b>																						
Command	W	MT	MF	0	0	1	0	0	1	Command Codes	Command	W	MT	MF	SK	1	0	0	0	1	Command Codes	
	W	X	X	X	X	X	HD	US1	US0	Sector ID information prior to Command execution. The 4 bytes are commanded against header on Floppy Disk.		W	X	X	X	X	X	HD	US1	US0	Sector ID information prior to Command execution	
	W	-----C-----										W	-----C-----									
	W	-----H-----										W	-----H-----									
	W	-----R-----										W	-----R-----									
	W	-----N-----										W	-----N-----									
	W	-----EOT-----										W	-----EOT-----									
	W	-----GPL-----										W	-----GPL-----									
	W	-----DTL-----									W	-----STP-----										
Execution										Data-transfer between the FDD and main-system	Execution										Data-compared between the FDD and main-system	
Result	R	-----ST 0-----								Status information after Command execution	Result	R	-----ST 0-----								Status information after Command execution	
	R	-----ST 1-----										R	-----ST 1-----									
	R	-----ST 2-----										R	-----ST 2-----									
	R	-----C-----									Sector ID information after Command execution		R	-----C-----								
	R	-----H-----										R	-----H-----									
	R	-----R-----										R	-----R-----									
	R	-----N-----										R	-----N-----									

Note: ① Symbols used in this table are described at the end of this section.  
 ② Ag should equal binary 1 for all operations.  
 ③ X = Don't care, usually made to equal binary 0.

SECTION VI

**INSTRUCTION SET (CONT.)**

PHASE	R/W	DATA BUS								REMARKS	PHASE	R/W	DATA BUS								REMARKS				
		D7	D6	D5	D4	D3	D2	D1	D0				D7	D6	D5	D4	D3	D2	D1	D0					
<b>SCAN LOW OR EQUAL</b>																									
Command	W	MT	MF	SK	1	1	0	0	1	Command Codes	Sector ID information prior Command execution	Command	W	0	0	0	0	0	1	1	1	Command Codes			
	W	X	X	X	X	X	HD	US1	US0	Execution			W	X	X	X	X	X	0	US1	US0	Head retracted to Track 0			
Execution	W	C								Data-compared between the FDD and main-system	Command Codes	<b>SENSE INTERRUPT STATUS</b>													
	W	H										Command Codes	W	0	0	0	0	1	0	0	0	Status information at the end of seek-operation about the FDC			
	W	R											Result	R	STO										
	W	N												Command Codes	<b>SPECIFY</b>										
	W	EOT													Command Codes	W	0	0	0	0	0		0	1	1
	W	GPL														Command Codes	W	SRT → HUT							
W	STP								Command Codes	W	HLT → ND														
Result	R	ST 0								Status information after Command execution	<b>SENSE DRIVE STATUS</b>														
	R	ST 1									Command Codes	W	0				0	0	0	0	1	0	0		
	R	ST 2										Command Codes	W	X			X	X	X	X	HD	US1	US0		
	R	C											Command Codes	Result	R		ST 3								
	R	H													Command Codes	<b>SEEK</b>									
	R	R														Command Codes	W	0	0	0	0	1	1	1	1
R	N								Command Codes	W							X	X	X	X	X	HD	US1	US0	
<b>SCAN HIGH OR EQUAL</b>																									
Command	W	MT	MF	SK	1	1	1	0		1	Command Codes	Sector ID information prior Command execution					Command	W	0	0	0	0	1	1	1
	W	X	X	X	X	X	HD	US1		US0	Execution		W	X				X	X	X	X	HD	US1	US0	Head is positioned over proper Cylinder on Diskette
Execution	W	C								Data-compared between the FDD and main-system	Command Codes	<b>INVALID</b>													
	W	H										Command Codes	Command	W	Invalid Codes										
	W	R												Command Codes	Result	R	ST 0								
	W	N														Command Codes	Invalid Command Codes (NoOp - FDC goes into Standby State)								
	W	EOT															Command Codes	ST 0 = 80 (16)							
	W	GPL																Command Codes							
W	STP								Command Codes																
Result	R	ST 0								Status information after Command execution															
	R	ST 1									Command Codes														
	R	ST 2										Command Codes													
	R	C											Command Codes												
	R	H												Command Codes											
	R	R													Command Codes										
R	N								Command Codes																

**FUNCTIONAL DESCRIPTION OF COMMANDS**

**Read Data**

A set of nine (9) byte words are required to place the FDC into the Read Data Mode. After the Read Data command has been issued the FDC loads the head (if it is in the unloaded state), waits the specified head settling time (defined in the Specify Command), and begins reading ID Address Marks and ID fields. When the current sector number ("R") stored in the ID Register (IDR) compares with the sector number read off the diskette, then the FDC outputs data (from the data field) byte-to-byte to the main system via the data bus.

After completion of the read operation from the current sector, the Sector Number is incremented by one, and the data

from the next sector is read and output on the data bus. This continuous read function is called a "Multi-Sector Read Operation." The Read Data Command may be terminated by the receipt of a Terminal Count signal. TC should be issued at the same time that the DACK for the last byte of data is sent. Upon receipt of this signal, the FDC stops outputting data to the processor, but will continue to read data from the current sector, check CRC (Cyclic Redundancy Count) bytes, and then at the end of the sector terminate the Read Data Command.

The amount of data which can be handled with a single command to the FDC depends upon MT (multi-track), MF (MFM/FM), and N (Number of Bytes/Sector). Table 1 below shows the Transfer Capacity.

Multi-Track MT	MFM/FM MF	Bytes/Sector N	Maximum Transfer Capacity (Bytes/Sector) (Number of Sectors)	Final Sector Read from Diskette
0	0	00	(128) (26) = 3,328	26 at Side 0
0	1	01	(256) (26) = 6,656	or 26 at Side 1
1	0	00	(128) (52) = 6,656	26 at Side 1
1	1	01	(256) (52) = 13,312	
0	0	01	(256) (15) = 3,840	15 at Side 0
0	1	02	(512) (15) = 7,680	or 15 at Side 1
1	0	01	(256) (30) = 7,680	15 at Side 1
1	1	02	(512) (30) = 15,360	
0	0	02	(512) (8) = 4,096	8 at Side 0
0	1	03	(1024) (8) = 8,192	or 8 at Side 1
1	0	02	(512) (16) = 8,192	8 at Side 1
1	1	03	(1024) (16) = 16,384	

**Table 1. Transfer Capacity**

The "multi-track" function (MT) allows the FDC to read data from both sides of the diskette. For a particular cylinder, data will be transferred starting at Sector 1, Side 0 and completing at Sector L, Side 1 (Sector L = last sector on the side). Note, this function pertains to only one cylinder (the same track) on each side of the diskette.

When  $N = 0$ , the DTL defines the data length which the FDC must treat as a sector. If DTL is smaller than the actual data length in a Sector, the data beyond DTL in the Sector, is not sent to the Data Bus. The FDC reads (internally) the complete Sector performing the CRC check, and depending upon the manner of command termination, may perform a Multi-Sector Read Operation. When  $N$  is non-zero, then DTL has no meaning and should be set to FF Hexidecimal.

At the completion of the Read Data command, the head is not unloaded until after Head Unload Time Interval (specified in the Specify Command) has elapsed. If the processor issues another command before the head unloads then the head settling time may be saved between subsequent reads. This time out is particularly valuable when a diskette is copied from one drive to another.

If the FDC detects the Index Hole twice without finding the right sector, (indicated in "R"), then the FDC sets the ND (No Data) flag in Status Register 1 to a 1 (high), and terminates the Read Data Command. (Status Register 0 also has bits 7 and 6 set to 0 and 1 respectively.)

After reading the ID and Data Fields in each sector, the FDC checks the CRC bytes. If a read error is detected (incorrect CRC in ID field), the FDC sets the DE (Data Error) flag in Status Register 1 to a 1 (high), and if a CRC error occurs in the Data Field the FDC also sets the DD (Data Error in Data Field) flag in Status Register 2 to a 1 (high), and terminates the Read Data Command. (Status Register 0 also has bits 7 and 6 set to 0 and 1 respectively.)

### Write Data

A set of nine (9) bytes are required to set the FDC into the Write Data mode. After the Write Data command has been issued the FDC loads the head (if it is in the unloaded state), waits the specified Head Settling Time (defined in the Specify Command), and begins reading ID Fields. When all four bytes loaded during the command (C, H, R, N) match the four bytes of the ID field from the diskette, the FDC takes data from the processor byte-by-byte via the data bus, and outputs it to the FDD.

After writing data into the current sector, the Sector Number stored in "R" is incremented by one, and the next data field is written into. The FDC continues this "Multi-Sector Write Operation" until the issuance of a Terminal Count signal. If a Terminal Count signal is sent to the FDC it continues writing into the current sector to complete the data field. If the Terminal Count signal is received while a data field is being written then the remainder of the data field is filled with 00 (zeros).

The FDC reads the ID field of each sector and checks the CRC bytes. If the FDC detects a read error (incorrect CRC) in one of the ID Fields, it sets the DE (Data Error) flag of Status Register 1 to a 1 (high), and terminates the Write Data Command. (Status Register 0 also has bits 7 and 6 set to 0 and 1 respectively.)

The Write Command operates in much the same manner as the Read Command. The following items are the same, and one should refer to the Read Data Command for details:

- Transfer Capacity
- EN (End of Cylinder) Flag

\*Time refers to 8" mode (MINI = low). When using 5.25" mode, these times are doubled.

If the FDC reads a Deleted Data Address Mark off the diskette, and the SK bit (bit D5 in the first Command Word) is not set ( $SK = 0$ ), then the FDC sets the CM (Control Mark) flag in Status Register 2 to a 1 (high), and terminates the Read Data Command, after reading all the data in the Sector. If  $SK = 1$ , the FDC skips the sector with the Deleted Data Address Mark and reads the next sector. The CRC bits in the deleted data field are not checked when  $SK = 1$ .

During disk data transfers between the FDC and the processor, via the data bus, the FDC must be serviced by the processor every 27  $\mu$ s in the FM Mode, and every 13  $\mu$ s in the MFM Mode\*, or the FDC sets the OR (Over Run) flag in Status Register 1 to a 1 (high), and terminates the Read Data Command.

If the processor terminates a read (or write) operation in the FDC, then the ID Information in the Result Phase is dependent upon the state of the MT bit and EOT byte. Table 2 shows the value for C, H, R, and N, when the processor terminates the Command.

MT	HD	Final Sector Transferred to Processor	ID Information at Result Phase			
			C	H	R	N
0	0	Less than EOT	NC	NC	R + 1	NC
	0	Equal to EOT	C + 1	NC	R = 01	NC
	1	Less than EOT	NC	NC	R + 1	NC
	1	Equal to EOT	C + 1	NC	R = 01	NC
0	0	Less than EOT	NC	NC	R + 1	NC
	0	Equal to EOT	NC	LSB	R = 01	NC
	1	Less than EOT	NC	NC	R + 1	NC
	1	Equal to EOT	C + 1	LSB	R = 01	NC

- Notes: 1. NC (No Change): The same value as the one at the beginning of command execution.  
 2. LSB (Least Significant Bit): The least significant bit of H is complemented.

- ND (No Data) Flag
- Head Unload Time Interval
- ID Information when the processor terminates command (see Table 2)
- Definition of DTL when  $N = 0$  and when  $N \neq 0$

In the Write Data mode, data transfers between the processor and FDC, via the Data Bus, must occur every 27  $\mu$ s in the FM mode, and every 13  $\mu$ s in the MFM mode. If the time interval between data transfers is longer than this then the FDC sets the OR (Over Run) flag in Status Register 1 to a 1 (high), and terminates the Write Data Command. (Status Register 0 also has bit 7 and 6 set to 0 and 1 respectively.)

### Write Deleted Data

This command is the same as the Write Data Command except a Deleted Data Address Mark is written at the beginning of the Data Field instead of the normal Data Address Mark.

### Read Deleted Data

This command is the same as the Read Data Command except that when the FDC detects a Data Address Mark at the beginning of a Data Field and  $SK = 0$  (low), it will read all the data in the sector and set the CM flag in Status Register 2 to a 1 (high), and then terminate the command. If  $SK = 1$ , then the FDC skips the sector with the Data Address Mark and reads the next sector.

### Read A Track

This command is similar to READ DATA Command except that this is a continuous READ operation where the entire

Format	Sector Size	N	SC	GPL <sup>①</sup>	GPL <sup>②③</sup>	
8" Standard Floppy						
FM Mode	128 bytes/sector	00	1A	07	1B	
	256	01	0F	0E	2A	
	512	02	08	1B	3A	
	1024	03	04	47	8A	
	2048	04	02	C8	FF	
	4096	05	01	C8	FF	
MFM Mode <sup>④</sup>	256	01	1A	0E	36	
	512	02	0F	1B	54	
	1024	03	08	35	74	
	2048	04	04	99	FF	
	4096	05	02	C8	FF	
5¼" Minifloppy	5¼" Minifloppy					
	FM Mode	128 bytes/sector	00	12	07	09
		128	00	10	10	19
		256	01	08	18	30
		512	02	04	46	87
		1024	03	02	C8	FF
		2048	04	01	C8	FF
	MFM Mode <sup>④</sup>	256	01	12	0A	0C
		256	01	10	20	32
		512	02	08	2A	50
		1024	03	04	80	F0
		2048	04	02	C8	FF
4096		05	01	C8	FF	
3½" Sony Micro Floppydisk *						
FM Mode	128 bytes/sector	0	0F	07	1B	
	256	1	09	0E	2A	
	512	2	05	1B	3A	
MFM Mode <sup>④</sup>	256	1	0F	0E	36	
	512	2	09	1B	54	
	1024	3	05	35	74	

**Table 3**

- Notes:** ① Suggested values of GPL in Read or Write commands to avoid splice point between data field and ID field of contiguous sections.  
 ② Suggested values of GPL in format command.  
 ③ All values except sector size and hexadecimal.  
 ④ In MFM mode FDC cannot perform a Read Write format operation with 128 bytes sector. (N = 00)

data field from each of the sectors are read. Immediately after encountering the INDEX HOLE, the FDC starts reading all data fields on the track, as continuous blocks of data. If the FDC finds an error in the ID or DATA CRC check bytes, it continues to read data from the track. The FDC compares the ID information read from each sector with the value stored in the IDR, and sets the ND flag of Status Register 1 to a 1 (high) if there is no comparison. Multi-track or skip operations are not allowed with this command.

### Scan Commands

The SCAN Commands allow data which is being read from the diskette to be compared against data which is being supplied from the main system. The FDC compares the data on a byte-by-byte basis, and looks for a sector of data which meets the conditions of  $D_{FDD} = D_{PROCESSOR}$ ,  $D_{FDD} \leq D_{PROCESSOR}$ , or  $D_{FDD} \geq D_{PROCESSOR}$ . The hexadecimal byte of FF either from memory or from FDD can be used as a mask byte because it always meet the condition of the compare. Ones

This command terminates when number of sectors read is equal to EOT. If the FDC does not find an ID Address Mark on the diskette after it encounters the INDEX HOLE for the second time, then it sets the MA (missing address mark) flag in Status register 1 to a 1 (high), and terminates the command. (Status Register 0 has bits 7 and 6 set to 0 and 1 respectively.)

### Read ID

The READ ID Command is used to give the present position of the recording head. The FDC stores the values from the first ID field it is able to read. If no proper ID Address Mark is found on the diskette, before the INDEX HOLE is encountered for the second time then the MA (Missing Address Mark) flag in Status Register 1 is set to a 1 (high), and if no data is found then the ND (No Data) flag is also set in Status Register 1 to a 1 (high). The command is then terminated with Bits 7 and 6 in Status Register 0 set to 0 and 1 respectively. During this command there is no data transfer between FDC and the CPU except during the result phase.

### Format A Track

The Format Command allows an entire track to be formatted. After the INDEX HOLE is detected, Data is written on the Diskette; Gaps, Address Marks, ID Fields and Data Fields, all per the IBM System 34 (Double Density) or System 3740 (Single Density) Format are recorded. The particular format which will be written is controlled by the values programmed into N (number of bytes/sector), SC (sectors/cylinder), GPL (Gap Length), and D (Data Pattern) which are supplied by the processor during the Command Phase. The Data Field is filled with the Byte of data stored in D. The ID Field for each sector is supplied by the processor; that is, four data requests per sector are made by the FDC for C (Cylinder Number), H (Head Number), R (Sector Number) and N (Number of Bytes/Sector). This allows the diskette to be formatted with nonsequential sector numbers, if desired.

The processor must send new values for C, H, R, and N to the FDC for each sector on the track. If FDC is set for DMA mode, it will issue 4 DMA requests per sector. If it is set for interrupt mode, it will issue four interrupts per sector and the processor must supply C, H, R and N load for each sector. The contents of the R register is incremented by one after each sector is formatted, thus, the R register contains a value of R when it is read during the Result Phase. This incrementing and formatting continues for the whole track until the FDC encounters the INDEX HOLE for the second time, whereupon it terminates the command.

If a FAULT signal is received from the FDD at the end of a write operation, then the FDC sets the EC flag of Status Register 0 to a 1 (high), and terminates the command after setting bits 7 and 6 of Status Register 0 to 0 and 1 respectively. Also the loss of a READY signal at the beginning of a command execution phase causes bits 7 and 6 of Status Register 0 to be set to 0 and 1 respectively.

Table 3 shows the relationship between N, SC, and GPL for various sector sizes:

complement arithmetic is used for comparison (FF = largest number, 00 = smallest number). After a whole sector of data is compared, if the conditions are not met, the sector number is incremental ( $R + STP \rightarrow R$ ), and the scan operation is continued. The scan operation continues until one of the following conditions occur; the conditions for scan are met (equal, low, or high), the last sector on the track is reached (EOT), or the terminal count signal is received.



If the conditions for scan are met then the FDC sets the SH (Scan Hit) flag Status Register 2 to a 1 (high), and terminates the Scan Command. If the conditions for scan are not met between the starting sector (as specified by R) and the last sector on the cylinder (EOT), then the FDC sets the SN (Scan Not Satisfied) flag of Status Register 2 to a 1 (high), and terminates the Scan Command. The receipt of a TERMINAL COUNT signal from the Processor or DMA Controller during the scan operation will cause the FDC to complete the comparison of the particular byte which is in process, and then to terminate the command. Table 4 shows the status of bits SH and SN under various conditions of SCAN.

COMMAND	STATUS REGISTER 2		COMMENTS
	BIT 2 = SN	BIT 3 = SH	
Scan Equal	0	1	$D_{FDD} = D_{PROCESSOR}$
	1	0	$D_{FDD} \neq D_{PROCESSOR}$
Scan Low or Equal	0	1	$D_{FDD} = D_{PROCESSOR}$
	0	0	$D_{FDD} < D_{PROCESSOR}$
	1	0	$D_{FDD} > D_{PROCESSOR}$
Scan High or Equal	0	1	$D_{FDD} = D_{PROCESSOR}$
	0	0	$D_{FDD} > D_{PROCESSOR}$
	1	0	$D_{FDD} < D_{PROCESSOR}$

Table 4

If the FDC encounters a Deleted Data Address Mark on one of the sectors (and SK = 0), then it regards the sector as the last sector on the cylinder, sets CM (Control Mark) flag of Status Register 2 to a 1 (high) and terminates the command. If SK = 1, the FDC skips the sector with the Deleted Address Mark, and reads the next sector. In the second case (SK = 1), the FDC sets the CM (Control Mark) flag of Status Register 2 to a 1 (high) in order to show that a Deleted Sector had been encountered.

When either the STP (contiguous sectors = 01, or alternate sectors = 02 sectors are read) or the MT (Multi-Track) are programmed, it is necessary to remember that the last sector on the track must be read. For example, if STP = 02, MT = 0, the sectors are numbered sequentially 1 through 26, and we start the Scan Command at sector 21; the following will happen. Sectors 21, 23 and 25 will be read, then the next sector (26) will be skipped and the Index Hole will be encountered before the EOT value of 26 can be read. This will result in an abnormal termination of the command. If the EOT has been set at 25 or the scanning started at sector 20, then the Scan Command would be completed in a normal manner.

During the Scan Command data is supplied by either the processor or DMA Controller for comparison against the data read from the diskette. In order to avoid having the OR (Over Run) flag set in Status Register 1, it is necessary to have the data available in less than 27  $\mu$ s (FM Mode) or 13  $\mu$ s (MFM Mode)\*. If an Overrun occurs the FDC ends the command with bits 7 and 6 of Status Register 0 set to 0 and 1, respectively.

### Seek

The read/write head within the FDD is moved from cylinder to cylinder under control of the Seek Command. FDC has four independent Present Cylinder Registers for each drive. They are clear only after Recalibrate command. The FDC compares the PCN (Present Cylinder Number) which is the current head position with the NCN (New Cylinder Number), and if there is a difference performs the following operation:

- PCN < NCN: Direction signal to FDD set to a 1 (high), and Step Pulses are issued. (Step In.)
- PCN > NCN: Direction signal to FDD set to a 0 (low), and Step Pulses are issued. (Step Out.)

\*Time refers to 8" mode (MINI = low). When using 5.25" mode, these times are doubled.

The rate at which Step Pulses are issued is controlled by SRT (Stepping Rate Time) in the SPECIFY Command. After each Step Pulse is issued NCN is compared against PCN, and when NCN = PCN, then the SE (Seek End) flag is set in Status Register 0 to a 1 (high), and the command is terminated. At this point FDC interrupt goes high. Bits DB<sub>0</sub>-DB<sub>3</sub> in Main Status Register are set during seek operation and are cleared by Sense Interrupt Status command.

During the Command Phase of the Seek operation the FDC is in the FDC BUSY state, but during the Execution Phase it is in the NON BUSY state. While the FDC is in the NON BUSY state, another Seek Command may be issued, and in this manner parallel seek operations may be done on up to 4 Drives at once. No other command could be issued for as long as FDC is in process of sending Step Pulses to any drive.

If an FDD is in a NOT READY state at the beginning of the command execution phase or during the seek operation, then the NR (NOT READY) flag is set in Status Register 0 to a 1 (high), and the command is terminated after bits 7 and 6 of Status Register 0 are set to 0 and 1 respectively.

If the time to write 3 bytes of seek command exceeds 150  $\mu$ s, the timing between first two Step Pulses may be shorter than set in the Specify command by as much as 1 ms.

### Recalibrate

The function of this command is to retract the read/write head within the FDD to the Track 0 position. The FDC clears the contents of the PCN counter, and checks the status of the Track 0 signal from the FDD. As long as the Track 0 signal is low, the Direction signal remains 0 (low) and Step Pulses are issued. When the Track 0 signal goes high, the SE (SEEK END) flag in Status Register 0 is set to a 1 (high) and the command is terminated. If the Track 0 signal is still low after 77 Step Pulses have been issued, the FDC sets the SE (SEEK END) and EC (EQUIPMENT CHECK) flags of Status Register 0 to both 1s (highs), and terminates the command after bits 7 and 6 of Status Register 0 is set to 0 and 1 respectively.

The ability to do overlap RECALIBRATE Commands to multiple FDDs and the loss of the READY signal, as described in the Seek Command, also applies to the RECALIBRATE Command.

### Sense Interrupt Status

An Interrupt signal is generated by the FDC for one of the following reasons:

1. Upon entering the Result Phase of:
  - a. Read Data Command
  - b. Read a Track Command
  - c. Read ID Command
  - d. Read Deleted Data Command
  - e. Write Data Command
  - f. Format a Cylinder Command
  - g. Write Deleted Data Command
  - h. Scan Commands
2. Ready Line of FDD changes state
3. End of Seek or Recalibrate Command
4. During Execution Phase in the NON-DMA Mode

Interrupts caused by reasons 1 and 4 above occur during normal command operations and are easily discernible by the processor. During an execution phase in NON-DMA Mode, DB<sub>5</sub> in Main Status Register is high. Upon entering Result Phase this bit gets clear. Reason 1 and 4 does not require Sense Interrupt Status command. The interrupt is cleared by reading/writing data to FDC. Interrupts caused by reasons 2 and 3 above may be uniquely identified with the aid of the Sense Interrupt Status Command. This com-

mand when issued resets the interrupt signal and via bits 5, 6, and 7 of Status Register 0 identifies the cause of the interrupt.

SEEK END BITS 5	INTERRUPT CODE		CAUSE
	BIT 6	BIT 7	
0	1	1	Ready Line changed state, either polarity
1	0	0	Normal Termination of Seek or Recalibrate Command
1	1	0	Abnormal Termination of Seek or Recalibrate Command

Table 5

Neither the Seek or Recalibrate Command have a Result Phase. Therefore, it is mandatory to use the Sense Interrupt Status Command after these commands to effectively terminate them and to provide verification of where the head is positioned (PCN).

Issuing Sense Interrupt Status Command without interrupt pending is treated as an invalid command.

### Specify

The Specify Command sets the initial values for each of the three internal timers. The HUT (Head Unload Time) defines the time from the end of the Execution Phase of one of the Read/Write Commands to the head unload state. This timer is programmable from 16 to 240 ms in increments of 16 ms (01 = 16 ms, 0 = 32 ms...OF = 240 ms). The SRT (Step Rate Time) defines the time interval between adjacent step pulses. This timer is programmable from 1 to 16 ms in increments of 1 ms (F = 1 ms, E = 2 ms, D = 3 ms, etc.). The HLT (Head Load Time) defines the time between when the Head Load signal goes high and when the Read/Write

operation starts. This timer is programmable from 2 to 254 ms in increments of 2 ms (01 = 2 ms, 02 = 4 ms, 03 = 6 ms...7F = 254 ms).

The time interval mentioned above is a direct function of the MINI (pin 32). Times indicated above are for MINI set to 0. In a mini floppy application all time intervals are increased by a factor of 2.

The choice of DMA or NON-DMA operation is made by the ND (NON-DMA) bit. When this bit is high (ND = 1) the NON-DMA mode is selected, and when ND = 0 the DMA mode is selected.

### Sense Drive Status

This command may be used by the processor whenever it wishes to obtain the status of the FDDs. Status Register 3 contains the Drive Status information stored internally in FDC registers.

### Invalid

If an invalid command is sent to the FDC (a command not defined above), then the FDC will terminate the command after bits 7 and 6 of Status Register 0 are set to 1 and 0 respectively. No interrupt is generated by the FDC 9267 during this condition. Bit 6 and bit 7 (DIO and RQM) in the Main Status Register are both high ("1") indicating to the processor that the FDC 9267 is in the Result Phase and the contents of Status Register 0 (STO) must be read. When the processor reads Status Register 0 it will find an 80 hex indicating an invalid command was received.

A Sense Interrupt Status Command must be sent after a Seek or Recalibrate Interrupt, otherwise the FDC will consider the next command to be an Invalid Command.

In some applications the user may wish to use this command as a No-Op command, to place the FDC in a standby or no operation state.

## STATUS REGISTER IDENTIFICATION

NO.	BIT		DESCRIPTION
	NAME	SYMBOL	
D <sub>7</sub> D <sub>6</sub>	Interrupt Code	IC	D <sub>7</sub> = 0 and D <sub>6</sub> = 0 Normal Termination of Command, (NT). Command was completed and properly executed.
			D <sub>7</sub> = 0 and D <sub>6</sub> = 1 Abnormal Termination of Command, (AT). Execution of Command was started, but was not successfully completed.
			D <sub>7</sub> = 1 and D <sub>6</sub> = 0 Invalid Command issue, (IC). Command which was issued was never started.
			D <sub>7</sub> = 1 and D <sub>6</sub> = 1 Abnormal Termination because during command execution the ready signal from FDD changed state.
D <sub>5</sub>	Seek End	SE	When the FDC completes the SEEK Command, this flag is set to 1 (high).
D <sub>4</sub>	Equipment Check	EC	If a fault Signal is received from the FDD, or if the Track 0 Signal fails to occur after 77 Step Pulses (Recalibrate Command) then this flag is set.
D <sub>3</sub>	Not Ready	NR	When the FDD is in the not-ready state and a read or write command is issued, this flag is set. If a read or write command is issued to Side 1 of a single sided drive, then this flag is set.
D <sub>2</sub>	Head Address	HD	This flag is used to indicate the state of the head at Interrupt.
D <sub>1</sub>	Unit Select 1	US 1	These flags are used to indicate a Drive Unit. Number at Interrupt.
D <sub>0</sub>	Unit Select 0	US 0	

BIT			DESCRIPTION
NO.	NAME	SYMBOL	
<b>STATUS REGISTER 1 (CONT.)</b>			
D <sub>7</sub>	End of Cylinder	EN	When the FDC tries to access a Sector beyond the final Sector of a Cylinder, this flag is set.
D <sub>6</sub>			Not used. This bit is always 0 (low).
D <sub>5</sub>	Data Error	DE	When the FDC detects a CRC error in either the ID field or the data field, this flag is set.
D <sub>4</sub>	Over Run	OR	If the FDC is not serviced by the main-systems during data transfers, within a certain time interval, this flag is set.
D <sub>3</sub>			Not used. This bit always 0 (low).
D <sub>2</sub>	No Data	ND	During execution of READ DATA, WRITE DELETED DATA or SCAN Command, if the FDC cannot find the Sector specified in the IDR Register, this flag is set. During executing the READ ID Command, if the FDC cannot read the ID field without an error, then this flag is set. During the execution of the READ A Cylinder Command, if the starting sector cannot be found, then this flag is set.
D <sub>1</sub>	Not Writable	NW	During execution of WRITE DATA, WRITE DELETED DATA or Format A Cylinder Command, if the FDC detects a write protect signal from the FDD, then this flag is set.
D <sub>0</sub>	Missing Address Mark	MA	If the FDC cannot detect the ID Address Mark after encountering the index hole twice, then this flag is set. If the FDC cannot detect the Data Address Mark or Deleted Data Address Mark, this flag is set. Also at the same time, the MD (Missing Address Mark in Data Field) of Status Register 2 is set.
<b>STATUS REGISTER 2</b>			
D <sub>7</sub>			Not used. This bit is always 0 (low).
D <sub>6</sub>	Control Mark	CM	During executing the READ DATA or SCAN Command, if the FDC encounters a sector which contains a Deleted Data Address Mark, this flag is set.
D <sub>5</sub>	Data Error in Data Field	DD	If the FDC detects a CRC error in the data field then this flag is set.
D <sub>4</sub>	Wrong Cylinder	WC	This bit is related with the ND bit, and when the contents of C on the medium is different from that stored in the IDR, this flag is set.
D <sub>3</sub>	Scan Equal Hit	SH	During execution, the SCAN Command, if the condition of "equal" is satisfied, this flag is set.
D <sub>2</sub>	Scan Not Satisfied	SN	During executing the SCAN Command, if the FDC cannot find a Sector on the cylinder which meets the condition, then this flag is set.
D <sub>1</sub>	Bad Cylinder	BC	This bit is related with the ND bit, and when the content of C on the medium is different from that stored in the IDR and the content of C is FF, then this flag is set.
D <sub>0</sub>	Missing Address Mark in Data Field	MD	When data is read from the medium, if the FDC cannot find a Data Address Mark or Deleted Data Address Mark, then this flag is set.
<b>STATUS REGISTER 3</b>			
D <sub>7</sub>	Fault	FT	This bit is used to indicate the status of the Fault signal from the FDD.
D <sub>6</sub>	Write Protected	WP	This bit is used to indicate the status of the Write Protected signal from the FDD.
D <sub>5</sub>	Ready	RY	This bit is used to indicate the status of the Ready signal from the FDD.
D <sub>4</sub>	Track 0	T0	This bit is used to indicate the status of the Track 0 signal from the FDD.
D <sub>3</sub>	Two Side	TS	This bit is used to indicate the status of the Two Side signal from the FDD.
D <sub>2</sub>	Head Address	HD	This bit is used to indicate the status of Side Select signal to the FDD.
D <sub>1</sub>	Unit Select 1	US 1	This bit is used to indicate the status of the Unit Select 1 signal to the FDD.
D <sub>0</sub>	Unit Select 0	US 0	This bit is used to indicate the status of the Unit Select 0 signal to the FDD.

## PROCESSOR INTERFACE

During Command or Result Phases the Main Status Register (described earlier) must be read by the processor before each byte of information is written into or read from the Data Register. After each byte of data read or written to Data Register, CPU should wait for 12  $\mu$ s before reading MSR. Bits D6 and D7 in the Main Status Register must be in a 0 and 1 state, respectively, before each byte of the command word may be written in the FDC 9267. Many of the commands require multiple bytes, and as a result the Main Status Register must be read prior to each byte transfer to the FDC 9267. On the other hand, during the Result Phase, D6 and D7 in the Main Status Register must both be 1's (D6 = 1 and D7 = 1) before reading each byte from the Data Register. Note, this reading of the Main Status Register before each byte transfer to the FDC 9267 is required in only the Command and Result Phases, and NOT during the Execution Phase.

During the Execution Phase, the Main Status Register need not be read. If the FDC 9267 is in the NON-DMA Mode, then the receipt of each data byte (if FDC 9267 is reading data from FDD) is indicated by an Interrupt signal on pin 18 (INT = 1). The generation of a Read signal (RD = 0) or Write signal (WR = 0) will reset the Interrupt as well as output the Data onto the Data bus. If the processor cannot handle Interrupts fast enough (every 13  $\mu$ s) for MFM and 27  $\mu$ s for FM mode, then it may poll the Main Status Register and then bit D7 (RQM) functions just like the Interrupt signal. If a Write Command is in process then the WR signal performs the reset to the Interrupt signal.

If the FDC 9267 is in the DMA Mode, no Interrupts are generated during the Execution Phase. The FDC 9267 generates DRQ's (DMA Requests) when each byte of data is available. The DMA Controller responds to this request with both a DACK = 0 (DMA Acknowledge) and a RD = 0 (Read signal). When the DMA Acknowledge signal goes low (DACK = 0) then the DMA Request is reset (DRQ = 0). If a Write Command has been programmed then a WR signal will appear instead of RD. After the Execution Phase has been completed (Terminal Count has occurred) or EOT sector was read/written, then an Interrupt will occur (INT = 1). This signifies the beginning of the Result Phase. When the first byte of data is read during the Result Phase, the Interrupt is automatically reset (INT = 0).

It is important to note that during the Result Phase all bytes shown in the Command Table must be read. The Read Data Command, for example has seven bytes of data in the Result Phase. All seven bytes must be read in order to successfully complete the Read Data Command. The FDC 9267 will not accept a new command until all seven bytes have been read. Other commands may require fewer bytes to be read during the Result Phase.

The FDC 9267 contains five Status Registers. The Main Status Register mentioned above may be read by the processor at any time. The other four Status Registers (ST0, ST1, ST2, and ST3) are only available during the Result Phase, and may be read only after completing a command. The particular command which has been executed determines how many of the Status Registers will be read.

The bytes of data which are sent to the FDC 9267 to form the Command Phase, and are read out of the FDC 9267 in the Result Phase, must occur in the order shown in the Command Table. That is, the Command Code must be sent first and the other bytes sent in the prescribed sequence. No foreshortening of the Command or Result Phases are allowed. After the last byte of data in the Command Phase is sent to the FDC 9267, the Execution Phase automatically starts. In a similar fashion, when the last byte of data is read out in the Result Phase, the command is automatically ended and the FDC 9267 is ready for a new command.

## POLLING FEATURE OF THE FDC 9267

After the Specify command has been sent to the FDC 9267, the Unit Select line US0 and US1 will automatically go into a polling mode. In between commands (and between step pulses in the SEEK command) the FDC 9267 polls all four FDD's looking for a change in the Ready line from any of the drives. If the Ready line changes state (usually due to a door opening or closing) then the FDC 9267 will generate an interrupt. When Status Register 0 (ST0) is read (after Sense Interrupt Status is issued), Not Ready (NR) will be indicated. The polling of the Ready line by the FDC 9267 occurs continuously between commands, thus notifying the processor which drives are on or off line. Each drive is polled every 1.024 ms except during the Read/Write commands.

### AC TEST CONDITION

#### INPUT/OUTPUT

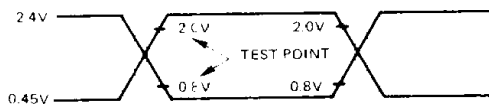

#### CLOCK

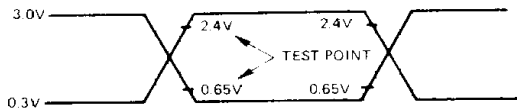

### AC TESTING

Inputs are driven at 2.4V for a logic "1" and 0.45V for a logic "0." Timing measurements are made at 2.0V for a logic "1" and 0.8V for a logic "0."

Clocks are driven at 3.0V for a logic "1" and 0.3V for a logic "0." Timing measurements are made at 2.4V for a logic "1" and 0.65V for a logic "0."

## PRECOMPENSATION

The desired precompensation delay is determined by the state of the MINI, P0 and P1 inputs. Logic levels present on these pins may be changed dynamically as long as the inputs are stable during the time the floppy disk controller is writing to the drive.

NOTE: The duration of the write pulse from pin 26 (WDOOUT) is to be a minimum of 250ns. for all precomp values.

MINI	P1	P0	PRECOMP
0	0	0	0.0ns
0	0	1	62.5ns
0	1	0	125.0ns
0	1	1	187.5ns
1	0	0	0.0ns
1	0	1	125.0ns
1	1	0	250.0ns
1	1	1	375.0ns

**TABLE 6**  
**WRITE PRECOMPENSATION VALUE SELECTION**

## TIMING DIAGRAMS

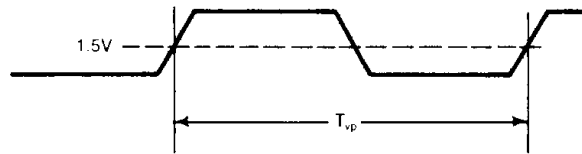
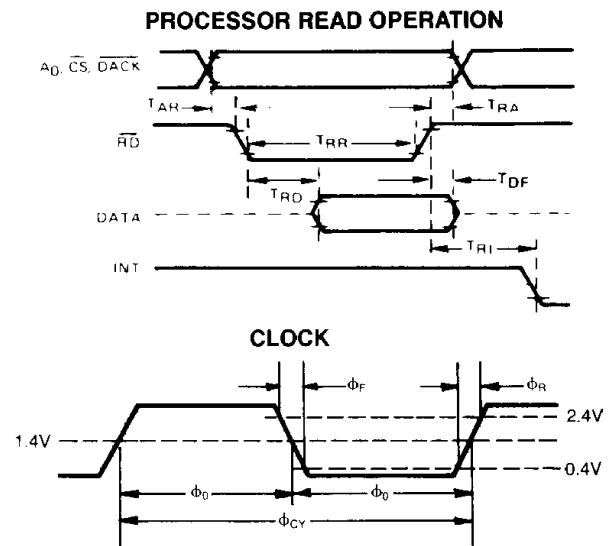

**FIGURE 1: VCOCLK TIMING**

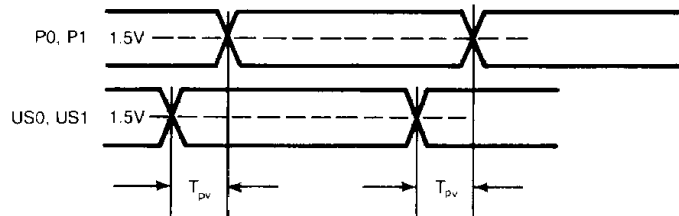

**FIGURE 2: PRECOMP VALUE TIMING**

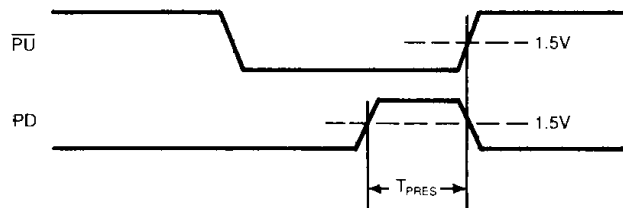

**FIGURE 3: PUMPUP TO PUMPDOWN TIMING**

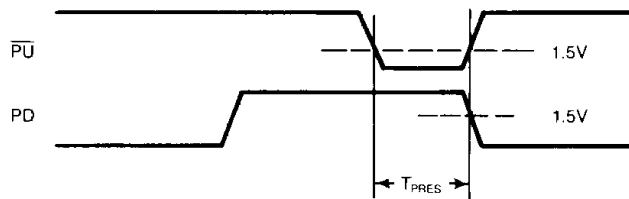

**FIGURE 4: PUMPDOWN TO PUMPUP TIMING**

## ELECTRICAL CHARACTERISTICS

### ABSOLUTE MAXIMUM RATINGS\*

Operating Temperature .....	0°C to +70°C
Storage Temperature .....	-55°C to +150°C
All Output Voltages .....	-0.5 to +7 Volts
All Input Voltages .....	-0.3 to +7 Volts
Supply Voltage $V_{CC}$ .....	-0.3 to +7 Volts
Power Dissipation .....	1 Watt

$T_a = 25^\circ\text{C}$

\*COMMENT: Stress above those listed under "Absolute Maximum Ratings" may cause permanent damage to the device. This is a stress rating only and functional operation of the device at these or any other conditions above those indicated in the operational sections of this specification is not implied. Exposure to absolute maximum rating conditions for extended periods may affect device reliability.

**DC CHARACTERISTICS**  $T_a = 0^\circ\text{C}$  to  $+70^\circ\text{C}$ ;  $V_{CC} = +5\text{V} \pm 5\%$  unless otherwise specified.

PARAMETER	SYMBOL	LIMITS			UNIT	TEST CONDITIONS
		MIN	TYP <sup>①</sup>	MAX		
Input Low Voltage	$V_{IL}$	-0.3		0.8	V	
Input High Voltage	$V_{IH}$	2.0		$V_{CC} + 0.5$	V	
Output Low Voltage	$V_{OL}$			0.45	V	$I_{OL} = 2.0\text{ mA}$
Output High Voltage	$V_{OH}$	2.4		$V_{CC}$	V	$I_{OH} = -200\ \mu\text{A}$
Input Low Voltage (CLK)	$V_{IL(i\phi)}$	-0.3		0.65	V	
Input High Voltage (CLK)	$V_{IH(i\phi)}$	2.4		$V_{CC} + 0.5$	V	
$V_{CC}$ Supply Current	$I_{CC}$			200	mA	
Input Load Current (All Input Pins)	$I_{LI}$			10	$\mu\text{A}$	$V_{IN} = V_{CC}$
				-10	$\mu\text{A}$	$V_{IN} = 0\text{V}$
High Level Output Leakage Current	$I_{LOH}$			10	$\mu\text{A}$	$V_{OUT} = V_{CC}$
Low Level Output Leakage Current	$I_{LOL}$			-10	$\mu\text{A}$	$V_{OUT} = +0.45\text{V}$

NOTE: <sup>①</sup>Typical values for  $T_a = 25^\circ\text{C}$  and nominal supply voltage.

**DC CHARACTERISTICS**  $T_a = 25^\circ\text{C}$ ;  $f_c = 1\text{ MHz}$ ;  $V_{CC} = 0\text{V}$

PARAMETER	SYMBOL	LIMITS			UNIT	TEST CONDITIONS
		MIN	TYP	MAX		
Clock Input Capacitance	$C_{IN(i\phi)}$			20	pF	All Pins Except Pin Under Test Tied to AC Ground
Input Capacitance	$C_{IN}$			10	pF	
Output Capacitance	$C_{OUT}$			20	pF	

**AC CHARACTERISTICS**  $T_a = 0^\circ\text{C}$  to  $+70^\circ\text{C}$ ;  $V_{cc} = +5\text{V} \pm 5\%$  unless otherwise specified.

PARAMETER	SYMBOL	LIMITS			UNIT	TEST CONDITIONS
		MIN	TYP <sup>①</sup>	MAX		
Clock period	$\phi_{CY}$	58	62.5	250	ns	
Clock Active (High, Low)	$\phi_{i}$	40%		60%		
Clock Rise Time	$\phi_r$			10	ns	
Clock Fall Time	$\phi_f$			10	ns	
$A_{0\bar{}}$ , CS, DACK Set Up Time to $\overline{RD}$ ↓	$T_{AR}$	0			ns	
$A_{0\bar{}}$ , CS, DACK Hold Time from $\overline{RD}$ ↑	$T_{HA}$	0			ns	
$\overline{RD}$ Width	$T_{FR}$	250			ns	
Data Access Time from $\overline{RD}$ ↓	$T_{RD}$			200	ns	$C_L = 100\text{ pF}$
DB to Float Delay Time from $\overline{RD}$ ↑	$T_{DF}$	20		100	ns	$C_L = 100\text{ pF}$
$A_{0\bar{}}$ , CS, DACK Set Up time to $\overline{WR}$ ↓	$T_{AW}$	0			ns	
$A_{0\bar{}}$ , CS, DACK Hold Time to $\overline{WR}$ ↑	$T_{WA}$	0			ns	
$\overline{WR}$ Width	$T_{WW}$	250			ns	
Data Set Up Time to $\overline{WR}$ ↑	$T_{DW}$	150			ns	
Data Hold Time from $\overline{WR}$ ↑	$T_{WD}$	5			ns	
INT Delay Time from $\overline{RD}$ ↑	$T_{RI}$			500	ns	
INT Delay Time from $\overline{WR}$ ↑	$T_{WI}$			500	ns	
DRQ Cycle Time	$T_{MCY}$	13			$\mu\text{s}$	
DRQ Delay Time from DACK ↓	$T_{AM}$			200	ns	
TC Width	$T_{TC}$	2			$\phi_{CY}$	
Reset Width	$T_{RST}$	28			$\phi_{CY}$	
RDD Active Time (High)	$T_{RDD}$	40			ns	
Window Cycle Time	$T_{WCY}$		2.0 1.0		$\mu\text{s}$	MFM = 0 MFM = 1
Window Hold Time to/from RDD	$T_{RDW}$ $T_{RHD}$	15			ns	
US, Hold Time to RW/SEEK ↓	$T_{US}$	12			$\mu\text{s}$	16 MHz Clock Period MINI pin = 0
SEEK RW Hold Time to LOW CURRENT DIRECTION ↑	$T_{SD}$	7			$\mu\text{s}$	
LOW CURRENT DIRECTION Hold Time to FAULT RESET/STEP ↑	$T_{DST}$	1.0			$\mu\text{s}$	
US, Hold Time from FAULT RESET/STEP ↓	$T_{STU}$	5.0			$\mu\text{s}$	
Step Active Time (High)	$T_{STP}$	6.0	7.0		$\mu\text{s}$	
Step Cycle Time	$T_{SC}$	33			$\mu\text{s}$	
FAULT RESET Active Time (High)	$T_{FR}$	8.0		10	$\mu\text{s}$	
Write Data Width (WDOUT)	$T_{WDO}$	250			ns	
US, Hold Time After SEEK	$T_{SU}$	15			$\mu\text{s}$	16 MHz Clock Period MINI pin = 0
Seek Hold Time from DIR	$T_{DS}$	30			$\mu\text{s}$	
DIR Hold Time after STEP	$T_{STD}$	24			$\mu\text{s}$	
Index Pulse Width	$T_{IDX}$	20			$\phi_{CY}$	
$\overline{WR}$ ↓, Delay from DRQ	$T_{MW}$	250			ns	16MHz Clock Period MINI pin = 0
WE or RD Response Time from DRQ ↑	$T_{MRW}$			12	$\mu\text{s}$	
VCOCLK Period	$T_{VCP}$	.46	.5	.56	$\mu\text{s}$	Figure 1
Rise and Fall Times				10	ns	Figure 1
Unit Select to Valid PRECOMP Value	$T_{UV}$			100	ns	Figure 2
Pump Reset Time	$T_{PRES}$			20	ns	Figure 3
Rise and Fall Times				10	ns	Figure 3

NOTES: ① Typical values for  $T_a = 25^\circ\text{C}$  and nominal supply voltage  
 ② The former value of 2 and 1 are applied to Standard Floppy, and the latter value of 4 and 2 are applied to Mini-floppy

③ Sony microfloppy 3 1/2" drive (8" compatible).  
 ④ Sony microfloppy 3 1/2" drive (5 1/4" compatible).

## TIMING DIAGRAMS

### PROCESSOR WRITE OPERATION

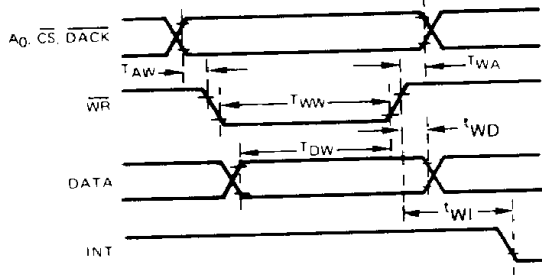

### DMA OPERATION

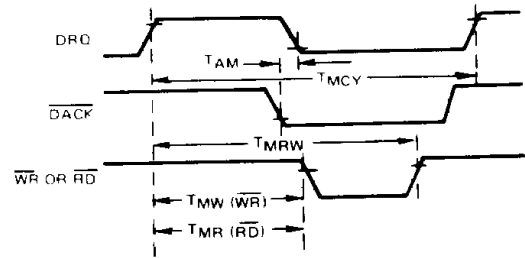

### SEEK OPERATION

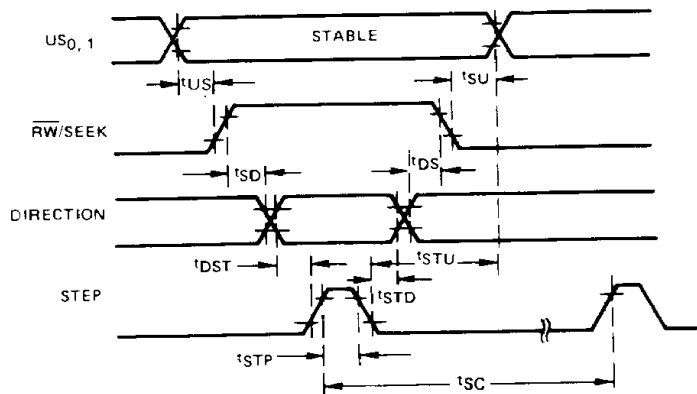

### FLT RESET

FAULT RESET =  
FILE UNSAFE RESET

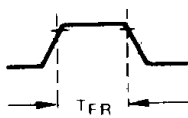

### INDEX

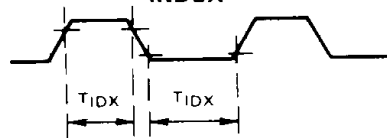

### TERMINAL COUNT



### FDD READ OPERATION

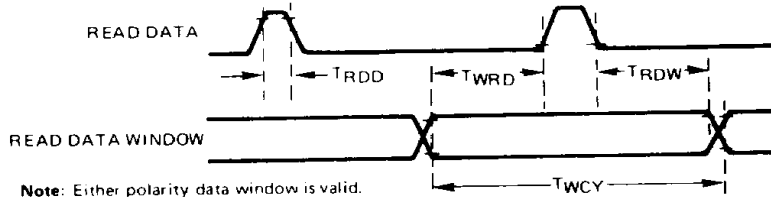

Note: Either polarity data window is valid.

### RESET

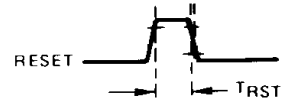

**STANDARD MICROSYSTEMS CORPORATION**

35 Marcus Blvd. Massapequa, N.Y. 11788  
 (516) 273-9100 FAX 516-273-8899

Circuit diagrams utilizing SMC products are included as a means of illustrating typical semiconductor applications; consequently complete information sufficient for construction purposes is not necessarily given. The information has been carefully checked and is believed to be entirely reliable. However, no responsibility is assumed for inaccuracies. Furthermore, such information does not convey to the purchaser of the semiconductor devices described any license under the patent rights of SMC or others. SMC reserves the right to make changes at any time in order to improve design and supply the best product possible.