



1.65V to 3.6V 512K×16 Intelliwatt™ low power CMOS SRAM with one chip enable

Features

- AS6UA51216
- Intelliwatt™ active power circuitry
- Industrial and commercial temperature ranges available
- Organization: 524,288 words × 16 bits
- 2.7V to 3.6V at 55 ns
- 2.3V to 2.7V at 70 ns
- 1.65V to 2.3V at 100 ns
- Low power consumption: ACTIVE
  - 144 mW at 3.6V and 55 ns
  - 68 mW at 2.7V and 70 ns
  - 28 mW at 2.3 V and 100 ns

- Low power consumption: STANDBY
  - 72 μW max at 3.6V
  - 41 μW max at 2.7V
  - 28 μW max at 2.3V
- 1.2V data retention
- Equal access and cycle times
- Easy memory expansion with CS, OE inputs
- Smallest footprint packages
  - 48-ball FBGA
  - 400-mil 44-pin TSOP II
- ESD protection ≥ 2000 volts
- Latch-up current ≥ 200 mA

Logic block diagram

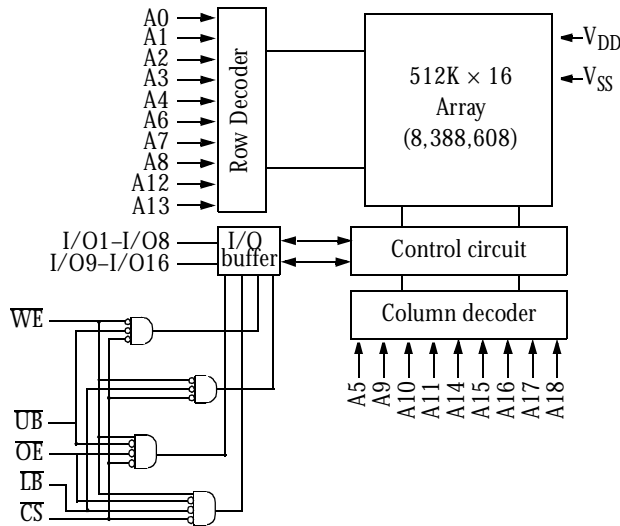

Pin arrangement (top view)

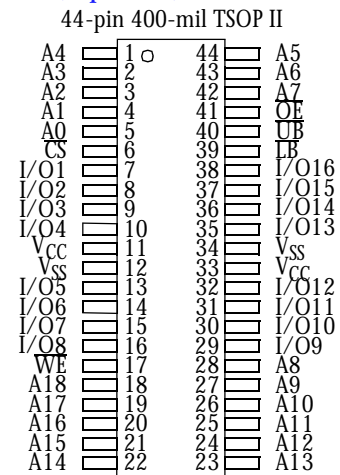

Note: A "MODE" pad is to be placed between pins 33 and 34 and 11 and 12, shorted. The bonding of this pad to V<sub>CC</sub> or V<sub>SS</sub> configures the device. There should only be 44+2+2 pads on the chip. Two extra V<sub>CC</sub> to separate out Array from Peripheral and Two-Mode Pads.

48-CSP Ball-Grid-Array Package

	1	2	3	4	5	6
A	LB	OE	A0	A1	A2	NC
B	I/O9	UB	A3	A4	CS	I/O1
C	I/O10	I/O11	A5	A6	I/O2	I/O3
D	V <sub>SS</sub>	I/O12	A17	A7	I/O4	V <sub>CC</sub>
E	V <sub>CC</sub>	I/O13	V <sub>SS</sub>	A16	I/O5	V <sub>SS</sub>
F	I/O15	I/O14	A14	A15	I/O6	I/O7
G	I/O16	NC	A12	A13	WE	I/O8
H	A18	A8	A9	A10	A11	NC

Selection guide

Product	V <sub>CC</sub> Range			Speed (ns)	Power Dissipation	
	Min (V)	Typ <sup>2</sup> (V)	Max (V)		Operating (I <sub>CC1</sub> )	Standby (I <sub>SB2</sub> )
					Max (mA)	Max (μA)
AS6UA51216	2.7	3.0	3.6	55	2	20
AS6UA51216	2.3	2.5	2.7	70	1	15
AS6UA51216	1.65	2.0	2.3	100	1	12



Functional description

The AS6UA51216 is a low-power CMOS 8,388,608-bit Static Random Access Memory (SRAM) device organized as 524,288 words × 16 bits. It is designed for memory applications where slow data access, low power, and simple interfacing are desired.

Equal address access and cycle times ( $t_{AA}$ ,  $t_{RC}$ ,  $t_{WC}$ ) of 55/70/100 ns are ideal for low-power applications. Active high and low chip enables ( $\overline{CS}$ ) permit easy memory expansion with multiple-bank memory systems.

When  $\overline{CS}$  is high, or  $\overline{UB}$  and  $\overline{LB}$  are high, the device enters standby mode: the AS6UA51216 is guaranteed not to exceed 72  $\mu$ W power consumption at 3.6V and 55ns; 41  $\mu$ W at 2.7V and 70 ns; or 28  $\mu$ W at 2.3V and 100 ns. The device also returns data when  $V_{CC}$  is reduced to 1.5V for even lower power consumption.

A write cycle is accomplished by asserting write enable ( $\overline{WE}$ ) and chip enable ( $\overline{CS}$ ) low, and  $\overline{UB}$  and/or  $\overline{LB}$  low. Data on the input pins I/O1–O16 is written on the rising edge of  $\overline{WE}$  (write cycle 1) or  $\overline{CS}$  (write cycle 2). To avoid bus contention, external devices should drive I/O pins only after outputs have been disabled with output enable ( $\overline{OE}$ ) or write enable ( $\overline{WE}$ ).

A read cycle is accomplished by asserting output enable ( $\overline{OE}$ ), chip enable ( $\overline{CS}$ ),  $\overline{UB}$  and  $\overline{LB}$  low, with write enable ( $\overline{WE}$ ) high. The chip drives I/O pins with the data word referenced by the input address. When either chip enable or output enable is inactive, or write enable is active, or ( $\overline{UB}$ ) and ( $\overline{LB}$ ), output drivers stay in high-impedance mode.

These devices provide multiple center power and ground pins, and separate byte enable controls, allowing individual bytes to be written and read.  $\overline{LB}$  controls the lower bits, I/O1–I/O8, and  $\overline{UB}$  controls the higher bits, I/O9–I/O16.

All chip inputs and outputs are CMOS-compatible, and operation is from either a single 1.65V to 3.6V supply. Device is available in the JEDEC standard 400-mL, TSOP II, and 48-ball FBGA packages.

Absolute maximum ratings

Parameter	Device	Symbol	Min	Max	Unit
Voltage on $V_{CC}$ relative to $V_{SS}$		$V_{IN}$	-0.5	$V_{CC} + 0.5$	V
Voltage on any I/O pin relative to GND		$V_{I/O}$	-0.5		V
Power dissipation		$P_D$	-	1.0	W
Storage temperature (plastic)		$T_{stg}$	-65	+150	°C
Temperature with $V_{CC}$ applied		$T_{bias}$	-55	+125	°C
DC output current (low)		$I_{OUT}$	-	20	mA

Note: Stresses greater than those listed under Absolute Maximum Ratings may cause permanent damage to the device. This is a stress rating only and functional operation of the device at these or any other conditions outside those indicated in the operational sections of this specification is not implied. Exposure to absolute maximum rating conditions for extended periods may affect reliability.

Truth table

$\overline{CS}$	$\overline{WE}$	$\overline{OE}$	$\overline{LB}$	$\overline{UB}$	Supply Current	I/O1–I/O8	I/O9–I/O16	Mode
H	X	X	X	X	$I_{SB}$	High Z	High Z	Standby ( $I_{SB}$ )
L	X	X	H	H				
L	H	H	X	X	$I_{CC}$	High Z	High Z	Output disable ( $I_{CC}$ )
L	H	L	L	H	$I_{CC}$	$D_{OUT}$	High Z	Read ( $I_{CC}$ )
			H	L		High Z	$D_{OUT}$	
			L	L		$D_{OUT}$	$D_{OUT}$	
L	L	X	L	H	$I_{CC}$	$D_{IN}$	High Z	Write ( $I_{CC}$ )
			H	L		High Z	$D_{IN}$	
			L	L		$D_{IN}$	$D_{IN}$	

Key: X = Don't care, L = Low, H = High.

**Recommended operating condition (over the operating range)**

Parameter	Description	Test Conditions	Min	Max	Unit	
V <sub>OH</sub>	Output HIGH Voltage	I <sub>OH</sub> = -2.1mA	V <sub>CC</sub> = 2.7V	2.4	V	
		I <sub>OH</sub> = -0.5mA	V <sub>CC</sub> = 2.3V	2.0		
		I <sub>OH</sub> = -0.1mA	V <sub>CC</sub> = 1.65V	1.5		
V <sub>OL</sub>	Output LOW Voltage	I <sub>OL</sub> = 2.1mA	V <sub>CC</sub> = 2.7V	0.4	V	
		I <sub>OL</sub> = 0.5mA	V <sub>CC</sub> = 2.3V	0.4		
		I <sub>OL</sub> = 0.1mA	V <sub>CC</sub> = 1.65V	0.2		
V <sub>IH</sub>	Input HIGH Voltage		V <sub>CC</sub> = 2.7V	2.2	V <sub>CC</sub> + 0.5	V
			V <sub>CC</sub> = 2.3V	2.0	V <sub>CC</sub> + 0.3	
			V <sub>CC</sub> = 1.65V	1.4	V <sub>CC</sub> + 0.3	
V <sub>IL</sub>	Input LOW Voltage		V <sub>CC</sub> = 2.7V	-0.5	0.8	V
			V <sub>CC</sub> = 2.3V	-0.3	0.6	
			V <sub>CC</sub> = 1.65V	-0.3	0.4	
I <sub>IX</sub>	Input Load Current	GND ≤ V <sub>IN</sub> ≤ V <sub>CC</sub>		-1	+1	μA
I <sub>OZ</sub>	Output Load Current	GND ≤ V <sub>O</sub> ≤ V <sub>CC</sub> ; Outputs High Z		-1	+1	μA
I <sub>CC</sub>	V <sub>CC</sub> Operating Supply Current	CS = V <sub>IL</sub> , V <sub>IN</sub> = V <sub>IL</sub> or V <sub>IH</sub> , I <sub>OUT</sub> = 0mA, f = 0	V <sub>CC</sub> = 3.6V	2	mA	
			V <sub>CC</sub> = 2.7V	1		
			V <sub>CC</sub> = 2.3V	1		
I <sub>CC1</sub> @ 1 MHz	Average V <sub>CC</sub> Operating Supply Current at 1 MHz	CS ≤ 0.2V, V <sub>IN</sub> ≤ 0.2V or V <sub>IN</sub> ≥ V <sub>CC</sub> - 0.2V, f = 1 mS	V <sub>CC</sub> = 3.6V	4	mA	
			V <sub>CC</sub> = 2.7V	2		
			V <sub>CC</sub> = 2.3V	2		
I <sub>CC2</sub>	Average V <sub>CC</sub> Operating Supply Current	CS ≠ V <sub>IL</sub> , V <sub>IN</sub> = V <sub>IL</sub> or V <sub>IH</sub> , f = f <sub>Max</sub>	V <sub>CC</sub> = 3.6V (55/70/100 mS)	40/30/20	mA	
			V <sub>CC</sub> = 2.7V (55/70/100 mS)	30/25/15		
			V <sub>CC</sub> = 2.3V(55/70/100 mS)	25/10/12		
I <sub>SB</sub>	CS Power Down Current; TTL Inputs	CS ≥ V <sub>IH</sub> or UB = LB ≥ V <sub>IH</sub> , other inputs = V <sub>IL</sub> or V <sub>IH</sub> , f = 0	V <sub>CC</sub> = 3.6V	100	μA	
			V <sub>CC</sub> = 2.7V	100		
			V <sub>CC</sub> = 2.3V	100		
I <sub>SB1</sub>	CS Power Down Current; CMOS Inputs	CS ≥ V <sub>CC</sub> - 0.2V or UB = LB ≥ V <sub>CC</sub> - 0.2V other inputs = 0V - V <sub>CC</sub> , f = f <sub>Max</sub>	V <sub>CC</sub> = 3.6V	20	μA	
			V <sub>CC</sub> = 2.7V	15		
			V <sub>CC</sub> = 2.3V	12		
I <sub>SBDR</sub>	Data Retention	CS ≥ V <sub>CC</sub> - 0.1V, UB = LB = V <sub>CC</sub> - 0.1V, f = 0	V <sub>CC</sub> = 1.2V	2	μA	

**Capacitance (f = 1 MHz, T<sub>a</sub> = Room temperature, V<sub>CC</sub> = NOMINAL)**

Parameter	Symbol	Signals	Test conditions	Max	Unit
Input capacitance	C <sub>IN</sub>	A, CS, WE, OE, LB, UB	V <sub>IN</sub> = 0V	5	pF
I/O capacitance	C <sub>I/O</sub>	I/O	V <sub>IN</sub> = V <sub>OUT</sub> = 0V	7	pF



Read cycle (over the operating range)

Parameter	Symbol	-55		-70		-100		Unit	Notes
		Min	Max	Min	Max	Min	Max		
Read cycle time	$t_{RC}$	55	-	70	-	100	-	ns	
Address access time	$t_{AA}$	-	55	-	70	-	100	ns	3
Chip enable ( $\overline{CS}$ ) access time	$t_{ACS}$	-	55	-	70	-	100	ns	3
Output enable ( $\overline{OE}$ ) access time	$t_{OE}$	-	25	-	35	-	50	ns	
Output hold from address change	$t_{OH}$	10	-	10	-	15	-	ns	5
$\overline{CS}$ to output in low Z	$t_{CLZ}$	10	-	10	-	10	-	ns	4, 5
$\overline{CS}$ high to output in high Z	$t_{CHZ}$	0	20	0	20	0	20	ns	4, 5
$\overline{OE}$ low to output in low Z	$t_{OLZ}$	5	-	5	-	5	-	ns	4, 5
$\overline{UB}/\overline{LB}$ access time	$t_{BA}$	-	55	-	70	-	100	ns	
$\overline{UB}/\overline{LB}$ low to low Z	$t_{BLZ}$	10	-	10	-	10	-	ns	4, 5
$\overline{UB}/\overline{LB}$ high to high Z	$t_{BHZ}$	0	20	0	20	0	20	ns	4, 5
$\overline{OE}$ high to output in high Z	$t_{OHZ}$	0	20	0	20	0	20	ns	4, 5
Power up time	$t_{PU}$	0	-	0	-	0	-	ns	4, 5
Power down time	$t_{PD}$	-	55	-	70	-	100	ns	4, 5

Shaded areas indicate preliminary information.

Key to switching waveforms

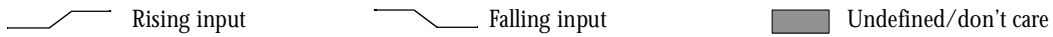

Read waveform 1 (address controlled)

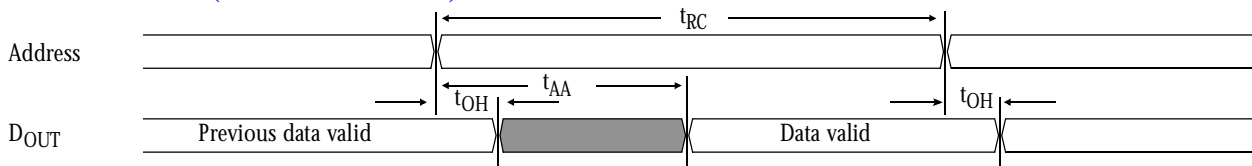

Read waveform 2 ( $\overline{CS}$ ,  $\overline{OE}$ ,  $\overline{UB}$ ,  $\overline{LB}$  controlled)

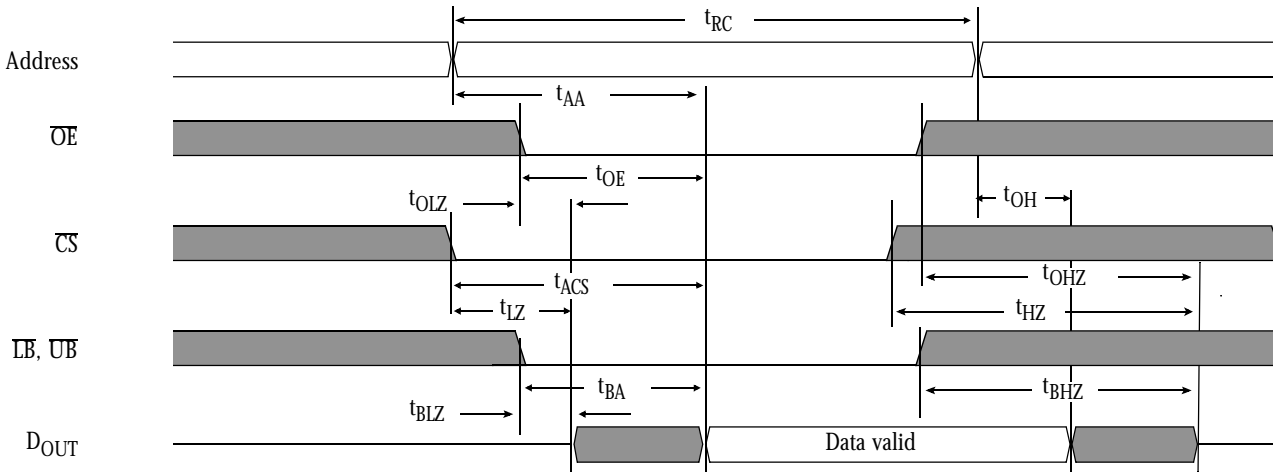



### Write cycle (over the operating range)

Parameter	Symbol	-55		-70		-100		Unit	Notes
		Min	Max	Min	Max	Min	Max		
Write cycle time	$t_{WC}$	55	–	70	–	100	–	ns	
Chip enable to write end	$t_{CW}$	40	–	60	–	80	–	ns	12
Address setup to write end	$t_{AW}$	40	–	60	–	80	–	ns	
Address setup time	$t_{AS}$	0	–	0	–	0	–	ns	12
Write pulse width	$t_{WP}$	35	–	55	–	70	–	ns	
Address hold from end of write	$t_{AH}$	0	–	0	–	0	–	ns	
Data valid to write end	$t_{DW}$	25	–	30	–	40	–	ns	
Data hold time	$t_{DH}$	0	–	0	–	0	–	ns	4, 5
Write enable to output in high Z	$t_{WZ}$	0	20	0	20	0	20	ns	4, 5
Output active from write end	$t_{OW}$	5	–	5	–	5	–	ns	4, 5
UB/LB low to end of write	$t_{BW}$	35	–	55	–	70	–	ns	

Shaded areas indicate preliminary information.

### Write waveform 1 (WE controlled)

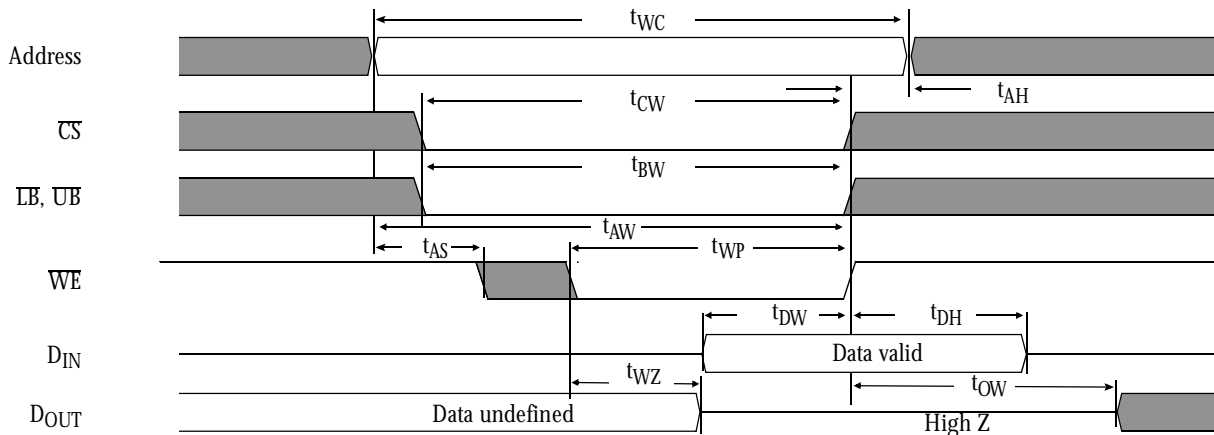

### Write waveform 2 (CS controlled)

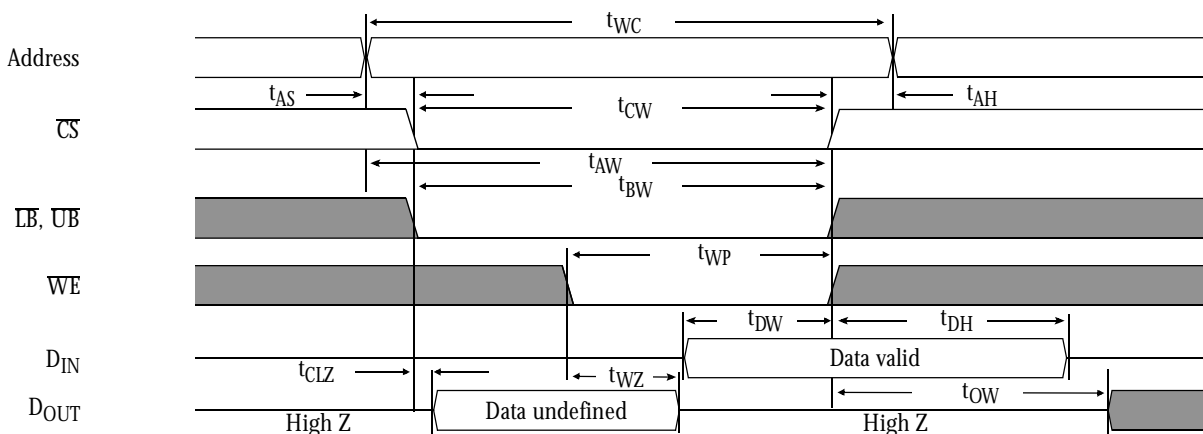



Data retention characteristics (over the operating range)

Parameter	Symbol	Test conditions	Min	Max	Unit
V <sub>CC</sub> for data retention	V <sub>DR</sub>	V <sub>CC</sub> = 1.2V	1.2V	3.6	V
Data retention current	I <sub>CCDR</sub>	CS ≥ V <sub>CC</sub> - 0.1V or UB = LB = > V <sub>CC</sub> - 0.1V	-	2	mA
Chip deselect to data retention time	t <sub>CDR</sub>	V <sub>IN</sub> ≥ V <sub>CC</sub> - 0.1V or V <sub>IN</sub> ≤ 0.1V	0	-	ns
Operation recovery time	t <sub>R</sub>		t <sub>RC</sub>	-	ns

Data retention waveform

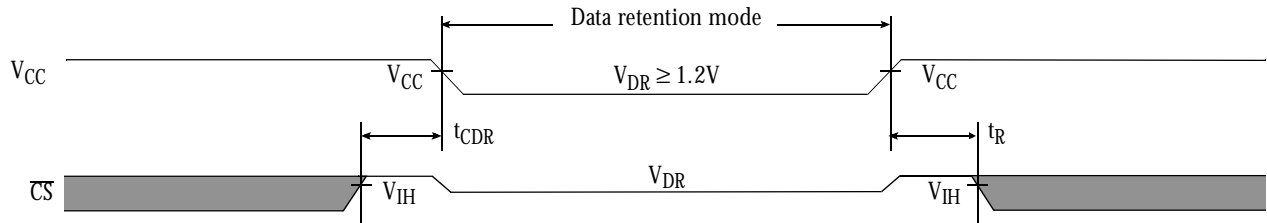

AC test loads and waveforms

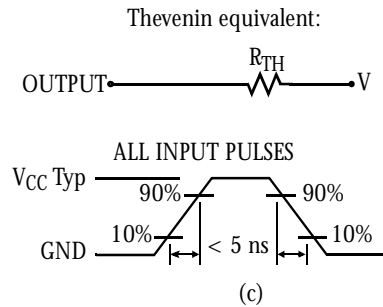
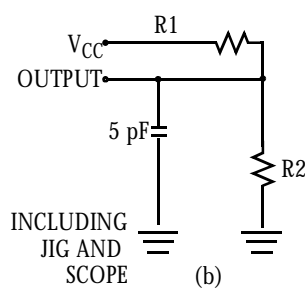
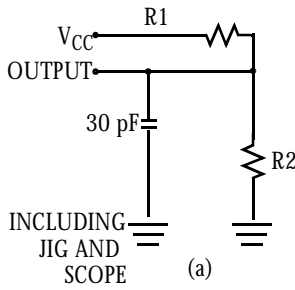

Parameters	V <sub>CC</sub> = 3.0V	V <sub>CC</sub> = 2.5V	V <sub>CC</sub> = 2.0V	Unit
R1	1105	16670	15294	Ohms
R2	1550	15380	11300	Ohms
R <sub>TH</sub>	645	8000	6500	Ohms
V <sub>TH</sub>	1.75V	1.2V	0.85V	Volts

Notes

- 1 During V<sub>CC</sub> power-up, a pull-up resistor to V<sub>CC</sub> on CS is required to meet I<sub>KB</sub> specification.
- 2 This parameter is sampled, but not 100% tested.
- 3 For test conditions, see AC Test Conditions.
- 4 t<sub>CLZ</sub> and t<sub>CHZ</sub> are specified with C<sub>L</sub> = 5pF as in Figure C. Transition is measured ±500 mV from steady-state voltage.
- 5 This parameter is guaranteed, but not tested.
- 6 WE is HIGH for read cycle.
- 7 CS and OE are LOW for read cycle.
- 8 Address valid prior to or coincident with CS transition LOW.
- 9 All read cycle timings are referenced from the last valid address to the first transitioning address.
- 10 CS or WE must be HIGH during address transitions. Either CS or WE asserting high terminates a write cycle.
- 11 All write cycle timings are referenced from the last valid address to the first transitioning address.
- 12 N/A.
- 13 1.2V data retention applies to commercial and industrial temperature range operations.
- 14 C = 30pF, except at high Z and low Z parameters, where C = 5pF.



Typical DC and AC characteristics

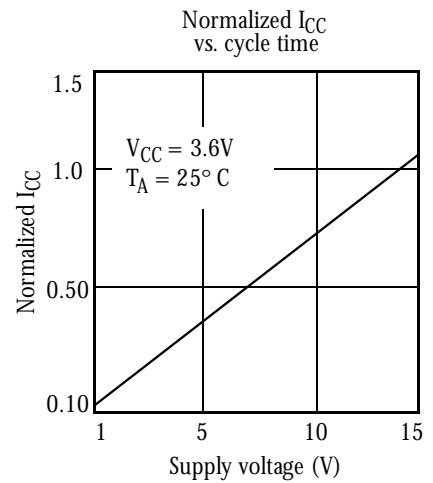
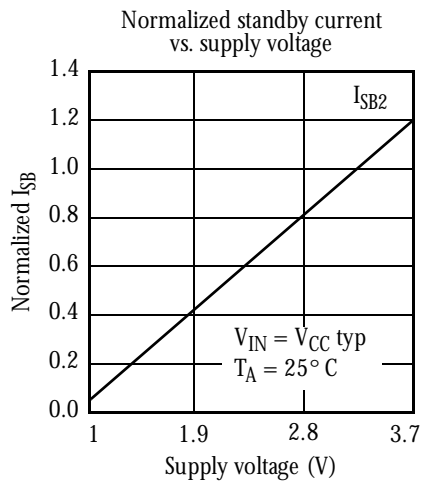
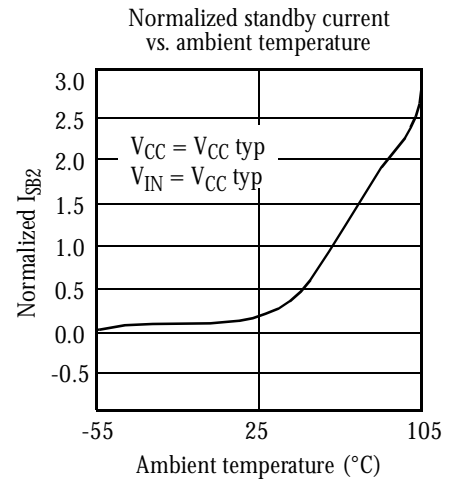
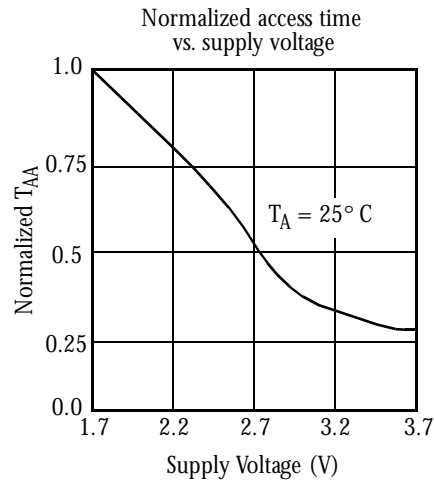
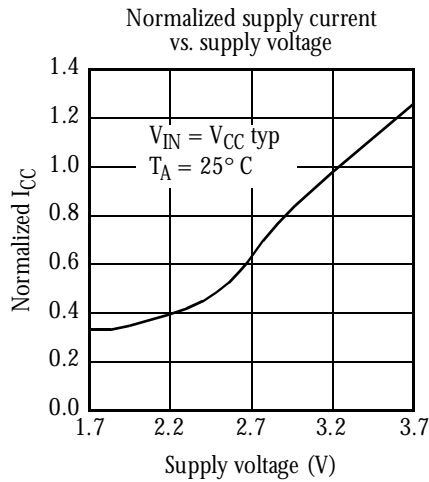

Package diagrams and dimensions

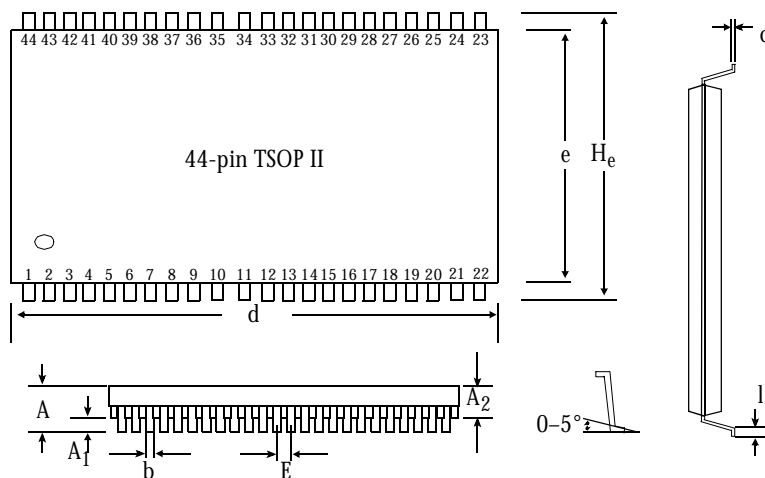

	44-pin TSOP II	
	Min (mm)	Max (mm)
A	1.2	
A <sub>1</sub>	0.05	
A <sub>2</sub>	0.95	1.05
b	0.25	0.45
c	0.15 (typical)	
d	20.85	21.05
e	10.06	10.26
H <sub>e</sub>	11.56	11.96
E	0.80 (typical)	
l	0.40	0.60



48-ball FBGA

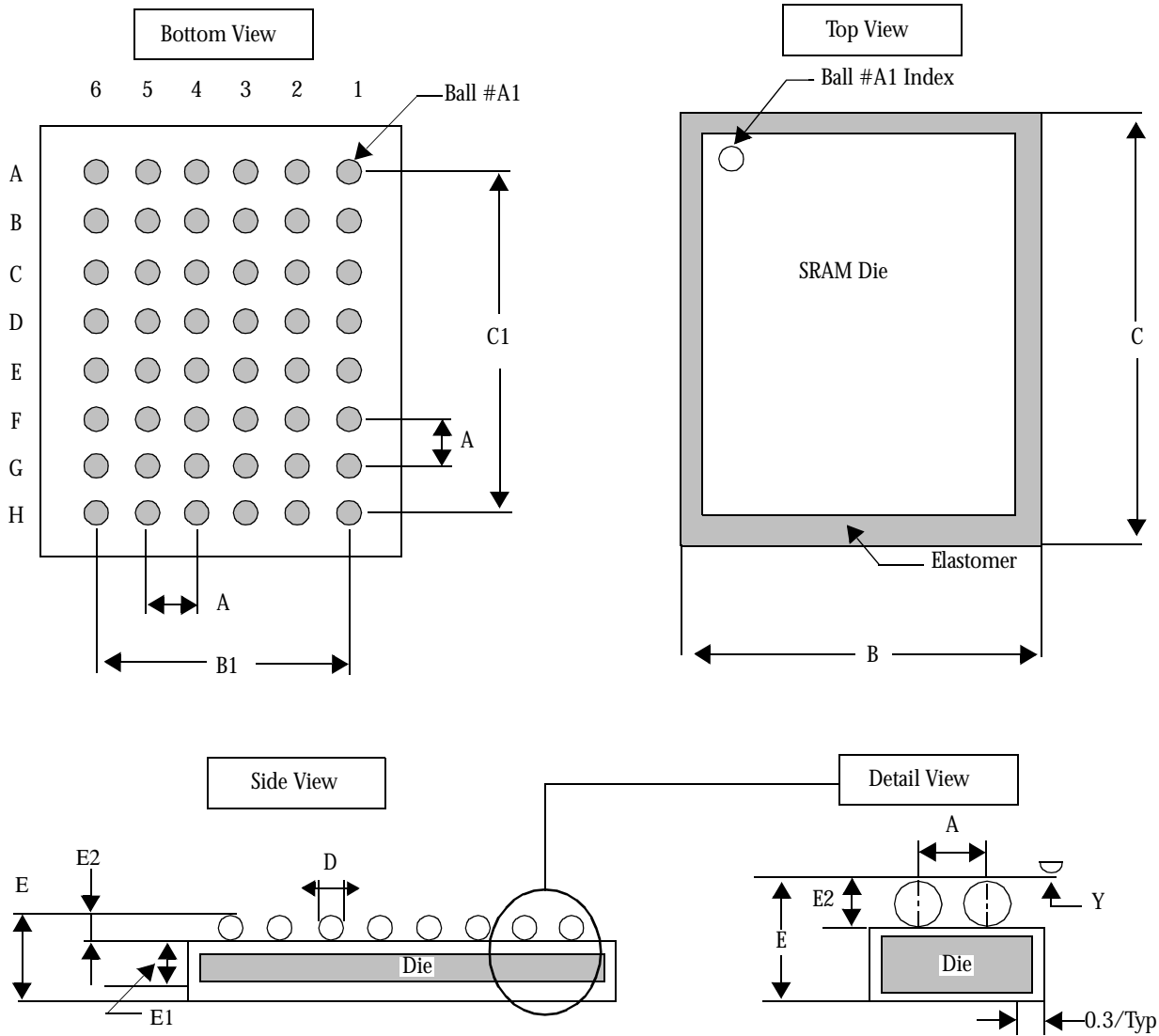

	Minimum	Typical	Maximum
A	-	0.75	-
B	6.90	7.00	7.10
B1	-	3.75	-
C	8.4	8.5	8.6
C1	-	5.25	-
D	0.30	0.35	0.40
E	-	-	1.20
E1	-	0.68	-
E2	0.22	0.25	0.27
Y	-	-	0.08

Notes

1. Bump counts: 48 (8 row × 6 column).
2. Pitch: (x,y) = 0.75 mm × 0.75 mm (typ).
3. Units: millimeters.
4. All tolerance are ± 0.050 unless otherwise specified.
5. Typ: typical.
6. Y is coplanarity: 0.08 (max).





### Ordering codes

Speed (ns)	Ordering Code	Package Type	Operating Range
55/70/100	AS6UA51216-TC	44-pin TSOP II	Commercial
	AS6UA51216-BC	48-ball fine pitch BGA	
	AS6UA51216-TI	44-pin TSOP II	Industrial
	AS6UA51216-BI	48-ball fine pitch BGA	

### Part numbering system

AS6UA	51216	B, T	C, I
SRAM Intelliwatt™ prefix	Device number	Package: T: TSOP II B: CSP BGA	Temperature range: C: Commercial: 0° C to 70° C I: Industrial: -40° C to 85° C