



SANYO Semiconductors

DATA SHEET

55GN01S — NPN Epitaxial Planar Silicon Transistor

UHF Wide-band Low-noise Amplifier Applications

Features

- High cutoff frequency : $f_T = 5.5\text{GHz typ.}$
- High gain : $|S_{21e}|^2 = 10\text{dB typ. (}f=1\text{GHz)}$.
- Ultrasmall package permitting applied sets to be small and slim.

Specifications

Absolute Maximum Ratings at $T_a = 25^\circ\text{C}$

Parameter	Symbol	Conditions	Ratings	Unit
Collector-to-Base Voltage	V_{CB0}		20	V
Collector-to-Emitter Voltage	V_{CEO}		10	V
Emitter-to-Base Voltage	V_{EBO}		3	V
Collector Current	I_C		70	mA
Collector Dissipation	P_C		100	mW
Junction Temperature	T_J		150	$^\circ\text{C}$
Storage Temperature	T_{stg}		-55 to +150	$^\circ\text{C}$

Electrical Characteristics at $T_a = 25^\circ\text{C}$

Parameter	Symbol	Conditions	Ratings			Unit
			min	typ	max	
Collector Cutoff Current	I_{CB0}	$V_{CB} = 10\text{V}, I_E = 0$			0.1	μA
Emitter Cutoff Current	I_{EBO}	$V_{EB} = 2\text{V}, I_C = 0$			1	μA
DC Current Gain	h_{FE}	$V_{CE} = 5\text{V}, I_C = 10\text{mA}$	100		180	
Gain-Bandwidth Product	f_T1	$V_{CE} = 3\text{V}, I_C = 5\text{mA}$	3.0	4.5		GHz
	f_T2	$V_{CE} = 5\text{V}, I_C = 20\text{mA}$		5.5		GHz
Output Capacitance	C_{ob}	$V_{CB} = 10\text{V}, f = 1\text{MHz}$		1.0	1.2	pF
Reverse Transfer Capacitance	C_{re}	$V_{CB} = 10\text{V}, f = 1\text{MHz}$		0.6		pF
Forward Transfer Gain	$ S_{21e} ^2$	$V_{CE} = 5\text{V}, I_C = 20\text{mA}, f = 1\text{GHz}$	7	10		dB
Noise Figure	NF	$V_{CE} = 3\text{V}, I_C = 5\text{mA}, f = 1\text{GHz}, Z_S = Z_L = 50\Omega$		1.9		dB

Marking : ZD

■ Any and all SANYO products described or contained herein do not have specifications that can handle applications that require extremely high levels of reliability, such as life-support systems, aircraft's control systems, or other applications whose failure can be reasonably expected to result in serious physical and/or material damage. Consult with your SANYO representative nearest you before using any SANYO products described or contained herein in such applications.

■ SANYO assumes no responsibility for equipment failures that result from using products at values that exceed, even momentarily, rated values (such as maximum ratings, operating condition ranges, or other parameters) listed in products specifications of any and all SANYO products described or contained herein.

Package Dimensions

unit : mm

2106A

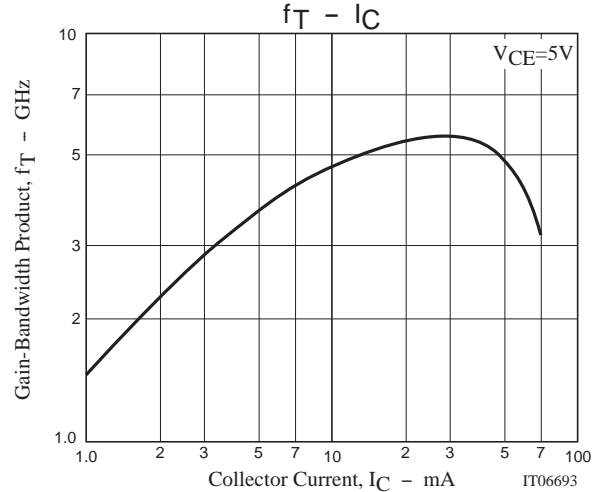
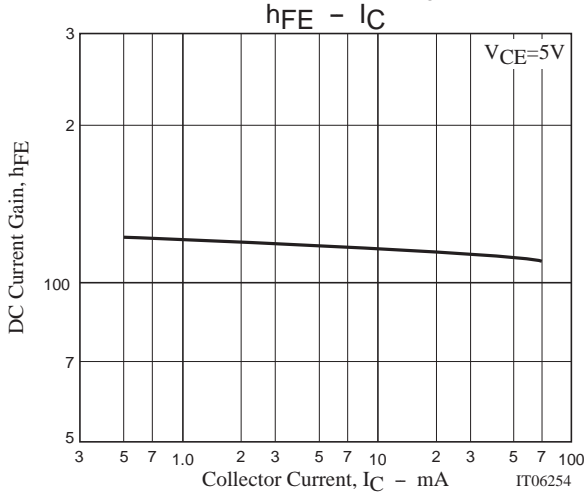
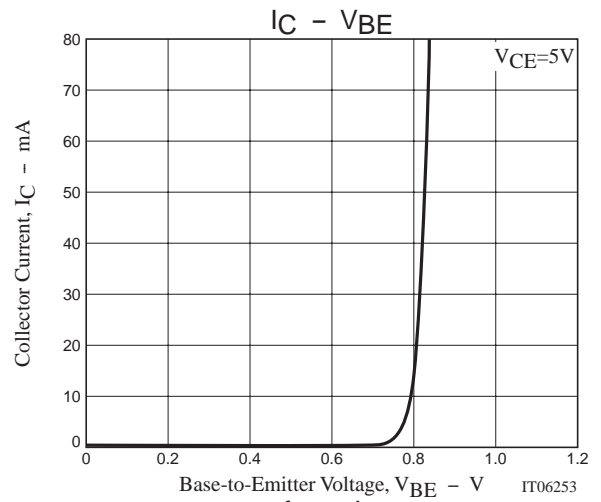
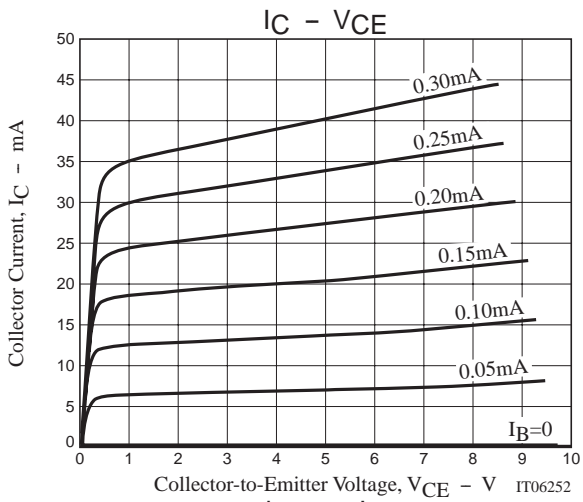
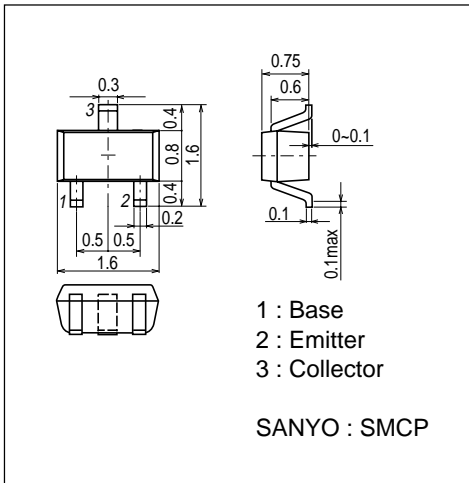

55GN01S

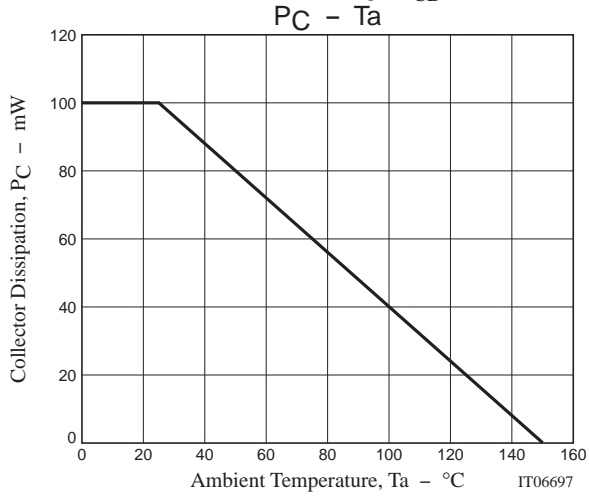
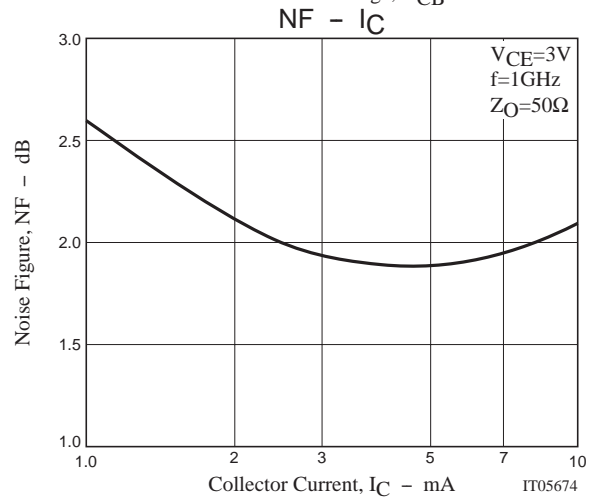
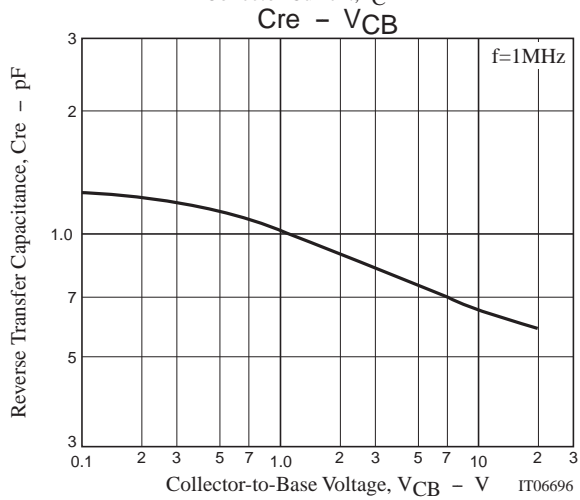
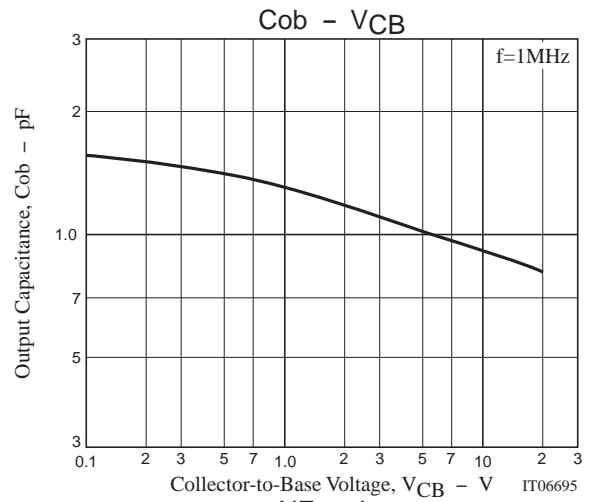
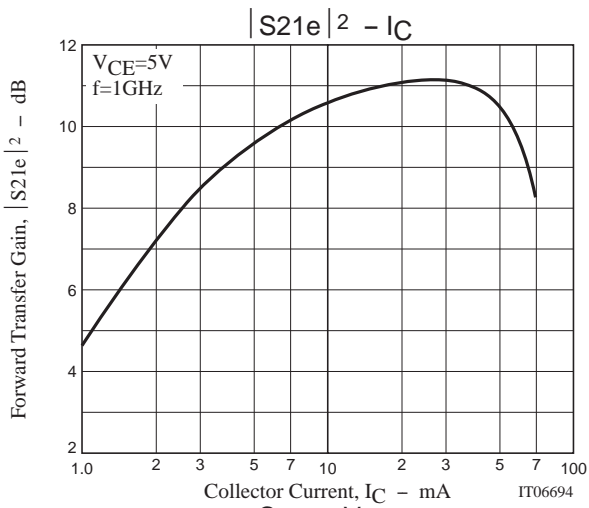

55GN01S

S Parameters (Common emitter)

$V_{CE}=5V, I_C=5mA, Z_O=50\Omega$

Freq(MHz)	$ S_{11} $	$\angle S_{11}$	$ S_{21} $	$\angle S_{21}$	$ S_{12} $	$\angle S_{12}$	$ S_{22} $	$\angle S_{22}$
100	0.818	-45.11	12.945	149.89	0.040	68.19	0.882	-23.66
200	0.723	-79.29	10.378	128.84	0.063	53.36	0.708	-38.25
400	0.619	-119.57	6.589	105.34	0.082	43.85	0.504	-50.00
600	0.590	-140.45	4.732	92.21	0.094	44.40	0.422	-54.83
800	0.566	-153.95	3.677	82.43	0.106	46.39	0.387	-58.60
1000	0.553	-163.02	3.000	74.67	0.118	48.68	0.369	-62.43
1200	0.546	-170.25	2.547	67.70	0.132	51.04	0.368	-65.91
1400	0.536	-176.36	2.214	61.57	0.145	53.10	0.374	-70.19
1600	0.529	178.47	1.979	55.95	0.162	54.51	0.376	-73.95
1800	0.518	173.34	1.790	50.69	0.178	55.69	0.387	-77.80
2000	0.515	168.18	1.642	45.28	0.197	56.79	0.393	-81.33
2200	0.506	163.01	1.499	40.79	0.216	56.84	0.403	-85.56
2400	0.502	158.27	1.394	36.26	0.236	56.80	0.415	-89.57
2600	0.496	153.59	1.299	32.33	0.257	56.63	0.423	-93.86
2800	0.495	148.84	1.220	28.79	0.281	56.40	0.431	-98.20
3000	0.488	144.62	1.152	25.31	0.307	55.34	0.440	-101.75

$V_{CE}=5V, I_C=10mA, Z_O=50\Omega$

Freq(MHz)	$ S_{11} $	$\angle S_{11}$	$ S_{21} $	$\angle S_{21}$	$ S_{12} $	$\angle S_{12}$	$ S_{22} $	$\angle S_{22}$
100	0.695	-65.56	19.851	138.84	0.033	62.31	0.773	-33.54
200	0.600	-104.03	13.662	117.33	0.049	51.12	0.552	-48.13
400	0.540	-139.63	7.785	97.63	0.065	51.35	0.370	-56.25
600	0.532	-154.82	5.405	87.15	0.081	53.63	0.312	-60.19
800	0.522	-165.18	4.152	79.02	0.099	57.04	0.294	-64.03
1000	0.517	-171.99	3.356	72.24	0.115	59.04	0.283	-67.23
1200	0.511	-177.34	2.845	66.21	0.134	59.83	0.284	-70.66
1400	0.507	177.38	2.469	60.71	0.153	59.98	0.294	-74.85
1600	0.498	173.40	2.199	55.55	0.172	60.01	0.300	-78.33
1800	0.493	169.08	1.991	50.67	0.191	59.81	0.309	-82.14
2000	0.489	164.42	1.824	45.74	0.212	59.31	0.315	-85.02
2200	0.483	159.69	1.665	41.25	0.234	58.55	0.327	-88.98
2400	0.479	155.72	1.549	36.93	0.254	57.22	0.337	-92.57
2600	0.474	151.50	1.446	32.96	0.272	56.69	0.345	-96.49
2800	0.474	146.89	1.358	29.71	0.296	55.40	0.353	-100.19
3000	0.469	142.97	1.283	26.10	0.318	54.29	0.364	-103.38

55GN01S

S Parameters (Common emitter)

$V_{CE}=5V, I_C=20mA, Z_O=50\Omega$

Freq(MHz)	$ S_{11} $	$\angle S_{11}$	$ S_{21} $	$\angle S_{21}$	$ S_{12} $	$\angle S_{12}$	$ S_{22} $	$\angle S_{22}$
100	0.570	-89.86	25.811	127.74	0.027	57.86	0.639	-42.89
200	0.520	-126.23	15.701	108.51	0.038	55.16	0.416	-54.85
400	0.503	-153.83	8.426	92.69	0.057	59.71	0.276	-59.96
600	0.506	-164.64	5.772	83.96	0.077	63.42	0.242	-62.99
800	0.504	-172.52	4.408	76.83	0.098	64.34	0.234	-67.02
1000	0.498	-177.66	3.555	70.62	0.116	64.27	0.228	-70.93
1200	0.496	177.98	3.013	65.15	0.139	64.39	0.235	-74.09
1400	0.492	173.75	2.611	59.99	0.158	63.46	0.246	-78.62
1600	0.488	170.09	2.319	55.01	0.179	63.02	0.252	-81.39
1800	0.481	166.42	2.096	50.36	0.200	61.78	0.262	-85.56
2000	0.481	162.19	1.917	45.65	0.221	60.80	0.268	-87.90
2200	0.472	158.01	1.760	41.21	0.240	59.60	0.283	-91.47
2400	0.472	154.06	1.633	37.24	0.260	57.83	0.293	-94.81
2600	0.467	149.87	1.523	33.18	0.280	56.85	0.300	-98.53
2800	0.467	145.82	1.434	29.86	0.304	55.35	0.311	-102.06
3000	0.462	142.08	1.354	26.43	0.326	53.94	0.318	-104.23

$V_{CE}=5V, I_C=30mA, Z_O=50\Omega$

Freq(MHz)	$ S_{11} $	$\angle S_{11}$	$ S_{21} $	$\angle S_{21}$	$ S_{12} $	$\angle S_{12}$	$ S_{22} $	$\angle S_{22}$
100	0.523	-103.16	27.751	122.53	0.024	59.02	0.569	-46.47
200	0.498	-136.49	16.132	104.97	0.035	57.80	0.361	-56.04
400	0.498	-159.57	8.503	90.63	0.054	63.85	0.244	-59.31
600	0.503	-168.52	5.802	82.53	0.076	67.20	0.219	-62.34
800	0.500	-175.28	4.429	75.68	0.097	66.04	0.215	-66.55
1000	0.499	-179.85	3.582	69.78	0.118	66.40	0.215	-70.37
1200	0.498	176.25	3.013	64.35	0.138	66.22	0.222	-73.72
1400	0.494	172.08	2.615	59.21	0.161	65.47	0.233	-78.23
1600	0.489	169.05	2.324	54.35	0.180	64.05	0.241	-81.44
1800	0.484	165.09	2.102	49.78	0.200	62.79	0.250	-85.19
2000	0.483	161.02	1.925	45.03	0.222	61.56	0.258	-87.77
2200	0.476	157.15	1.762	40.66	0.243	60.04	0.273	-90.81
2400	0.476	153.18	1.634	36.62	0.263	58.71	0.286	-94.60
2600	0.471	149.16	1.524	32.74	0.283	57.48	0.294	-98.35
2800	0.471	145.15	1.436	29.38	0.307	55.99	0.302	-101.47
3000	0.467	141.40	1.355	25.99	0.329	54.46	0.312	-103.95

- Specifications of any and all SANYO products described or contained herein stipulate the performance, characteristics, and functions of the described products in the independent state, and are not guarantees of the performance, characteristics, and functions of the described products as mounted in the customer's products or equipment. To verify symptoms and states that cannot be evaluated in an independent device, the customer should always evaluate and test devices mounted in the customer's products or equipment.
- SANYO Electric Co., Ltd. strives to supply high-quality high-reliability products. However, any and all semiconductor products fail with some probability. It is possible that these probabilistic failures could give rise to accidents or events that could endanger human lives, that could give rise to smoke or fire, or that could cause damage to other property. When designing equipment, adopt safety measures so that these kinds of accidents or events cannot occur. Such measures include but are not limited to protective circuits and error prevention circuits for safe design, redundant design, and structural design.
- In the event that any or all SANYO products(including technical data, services) described or contained herein are controlled under any of applicable local export control laws and regulations, such products must not be exported without obtaining the export license from the authorities concerned in accordance with the above law.
- No part of this publication may be reproduced or transmitted in any form or by any means, electronic or mechanical, including photocopying and recording, or any information storage or retrieval system, or otherwise, without the prior written permission of SANYO Electric Co., Ltd.
- Any and all information described or contained herein are subject to change without notice due to product/technology improvement, etc. When designing equipment, refer to the "Delivery Specification" for the SANYO product that you intend to use.
- Information (including circuit diagrams and circuit parameters) herein is for example only ; it is not guaranteed for volume production. SANYO believes information herein is accurate and reliable, but no guarantees are made or implied regarding its use or any infringements of intellectual property rights or other rights of third parties.

This catalog provides information as of May, 2004. Specifications and information herein are subject to change without notice.