



Design Example Report

Title	<i>13W Multiple Output Supply using TOP242P</i>
Specification	Input: 195 – 265 V _{AC} Output: 2.5V/0.8A, 3.3V/0.7A, 5V/1.45A, 9V/50mA, 32V/5mA
Application	Integrated Digital TV Decoder
Author	Power Integrations Applications Department
Document Number	DER-34
Date	April 1, 2004
Revision	1.0

Summary and Features

- No heatsinks on the complete power supply
- Low Parts Count – Total estimated total BOM cost <\$3.00
- Very low output ripple and noise – Eliminates PSU interference in TV

The products and applications illustrated herein (including circuits external to the products and transformer construction) may be covered by one or more U.S. and foreign patents or potentially by pending U.S. and foreign patent applications assigned to Power Integrations. A complete list of Power Integrations' patents may be found at www.powerint.com.

Table Of Contents

1	Introduction.....	3
2	Power Supply Specification.....	4
3	Schematic.....	5
4	Circuit Description	5
4.1	Design Architecture.....	6
4.2	Input Stage.....	6
4.3	Primary Side Clamp	6
4.4	Output Rectification, Filtering and Feedback.....	6
5	Bill Of Materials	7
6	Transformer Specification.....	8
6.1	Electrical Diagram	8
6.2	Electrical Specifications.....	8
6.3	Materials.....	8
6.4	Transformer Build Diagram	9
6.5	Winding Instructions.....	9
7	Transformer Spreadsheet.....	10
8	Measurements.....	13
8.1	Efficiency.....	13
8.2	Line Regulation	13
9	Operating Waveforms	14
9.1	Output Ripple	14
9.1.1	High Frequency Ripple (132kHz)	15
9.1.2	Low frequency output ripple (100Hz)	16
10	Conducted EMI Measurements	17
11	Revision History.....	18

Important Notes:

Although this board is designed to satisfy safety isolation requirements, the engineering prototype has not been agency approved. Therefore, all testing should be performed using an isolation transformer to provide the AC input to the prototype board.

Design Reports contain a power supply design specification, schematic, bill of materials, and transformer documentation. Performance data and typical operation characteristics are included. Typically only a single prototype has been built.



1 Introduction

This report describes a multiple output power supply for an integrated digital TV application. The design uses the advanced integrated features of TOP242P to give a low cost, minimal component count design.

The report includes a full schematic, bill of materials and transformer design information. In addition, basic measurements on the prototype unit shown in Figure 1 have been given.

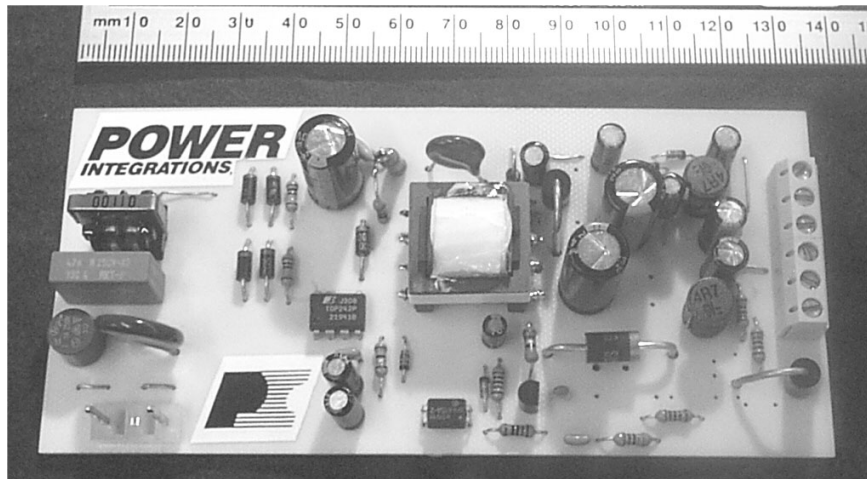

Figure 1 - 13W IdTV Power Supply Prototype

Measurements include full power efficiency, full power line regulation and output ripple measurements. When accurate min/max loads and loading combinations are known, cross-regulation measurements will be taken. Initial conducted EMI measurements have also been taken both with the output floating and the output grounded to protective Earth (i.e. chassis).

For the prototype constructed here, only one LC post filter was used on the 5V output and the current on the 5VA and 5VD circuitry was combined to a single rail. The proposed schematic splits the 5V rail out with two LC post filters to increase the separation between 5VA and 5VD outputs.

2 Power Supply Specification

Description	Symbol	Min	Typ	Max	Units	Comment
Input						
Voltage	V_{IN}	195		265	VAC	2 Wire – no P.E.
Frequency	f_{LINE}	47	50/60	64	Hz	
Output						
Output Voltage 1	V_{OUT1}	2.375	2.5	2.625	V	± 5% 20 MHz Bandwidth
Output Ripple Voltage 1	$V_{RIPPLE1}$			20	mV	
Output Current 1	I_{OUT1}			0.8	A	
Output Voltage 2	V_{OUT2}	3.15	3.3	3.45	V	± 5% 20 MHz Bandwidth
Output Ripple Voltage 2	$V_{RIPPLE2}$			30	mV	
Output Current 2	I_{OUT2}			0.7	A	
Output Voltage 3	V_{OUT3}	4.75	5	5.25	V	± 5% 20 MHz Bandwidth
Output Ripple Voltage 3	$V_{RIPPLE3}$			50	mV	
Output Current 3	I_{OUT3}		0.25	0.25	A	
Output Voltage 4	V_{OUT4}	4.75	5	5.25	V	± 5% 20 MHz Bandwidth
Output Ripple Voltage 4	$V_{RIPPLE4}$			50	mV	
Output Current 4	I_{OUT4}			1.2	A	
Output Voltage 5	V_{OUT5}	8.1	9	9.9	V	± 10% 20 MHz Bandwidth
Output Ripple Voltage 5	$V_{RIPPLE5}$			50	mV	
Output Current 5	I_{OUT5}			0.05	A	
Output Voltage 6	V_{OUT6}	29	32	35	V	± 10%
Output Ripple Voltage 6	$V_{RIPPLE6}$			300	mV	
Output Current 6	I_{OUT6}			0.005	A	
Total Output Power						
Continuous Output Power	P_{OUT}			13	W	
Efficiency	η	75			%	Measured at full load, 25 °C
Environmental						
Conducted EMI		Meets CISPR22B / EN55022B				
Ambient Temperature	T_{AMB}	0		45	°C	Free convection, sea level

Table 1 - Power Supply Specification

Notes:-

- 1) All separate 3V3 rail currents were combined onto a single rail
- 2) All separate 5V rail current were combined onto a single rail
- 3) Voltage regulation specifications have been assumed
- 4) Single 230V (195Vac to 265Vac) operation has been assumed



3 Schematic

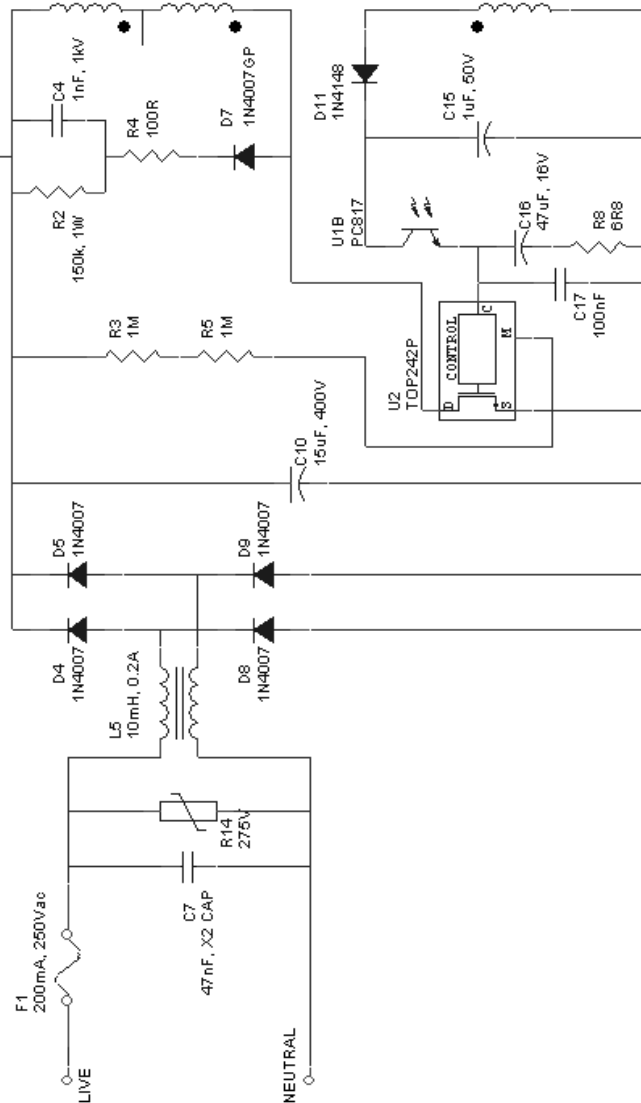
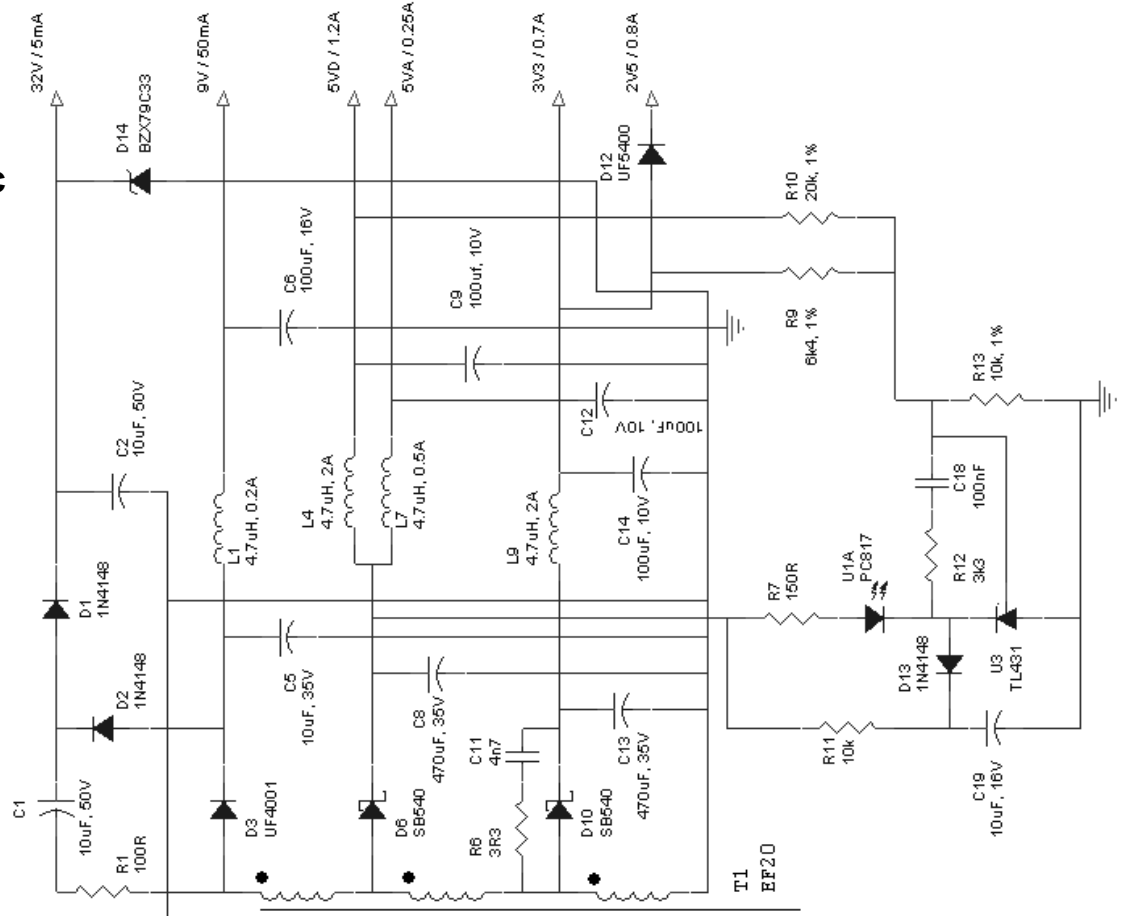

NOTES:

- 1) Use of 1N4007G bridge diodes can help EMI at 150 kHz.
- 2) soft-finish diode (D13) may not be needed.
- 3) Snubber cap C4 can be 400V.

Figure 2- Schematic

4 Circuit Description

This schematic presented above details an isolated flyback power supply using TOP242P from Power Integrations. This IC integrates the following features to minimize PSU cost:-

- Frequency jitter which reduces the QP and AV EMI levels by up to 10dB allowing for cheaper EMI filter components
- Soft-Start which prevents transformer saturation during start-up. This increases long term reliability
- Line UV and OV detection to give additional differential surge withstand capability to increase reliability
- Regulation to zero load without pre-load due to very low minimum duty cycle capability
- Line feed forward which improves 100Hz ripple rejection
- Hysteretic thermal and short circuit protection to increase long term reliability
- DIP08 package which requires no additional heatsink, minimizing BOM and manufacturing cost.

4.1 Design Architecture

The approach used with this design is to provide the 2.5V output via a diode drop from the 3V3 rail. This technique is a good way to cost effectively produce 2.5V without significant efficiency penalty. If tighter regulation is required on 2.5V, a feedback resistor from 2.5V to the TL431 can be added.

4.2 Input Stage

Mains input protection is provided by fuse F1 and a VDR, R14. Common-mode and differential mode EMI filtering is provided by C7, L5 and C3. AC rectification and bulk storage is provided by D4, D5, D8, D9 and C10.

4.3 Primary Side Clamp

Primary side clamping is provided by D7, R4, R2 and C4. D7 is specified as 1N4007GP and it is important that the GP version is used. The GP version has a specified reverse recovery behavior, which recycles some of the clamp energy and aid efficiency.

4.4 Output Rectification, Filtering and Feedback

Schottky diodes are used on both the 3V3 and 5V outputs to give good voltage centering and high efficiency. The 2V5 rail is provided using a UF5400 diode drop from the 3V3 rail. All rails use LC post filters to give very low output ripple and the 32V rail is provided by a charge pump driven from the AC side of the 32V winding.

Feedback is derived from the 3V3 and 5V windings, which will give +/-5% accuracy on both rails. If tighter regulation is required on 2.5V, a feedback resistor from 2.5V to the TL431 can be added.



5 Bill Of Materials

	Reference	Quantity	Value / Description
Capacitors	C1,C2	2	10uF, 50V
	C3	1	1nF, Y1 SAFETY
	C4	1	1nF, 1kV
	C5	1	10uF, 35V
	C6	1	100uF, 16V
	C7	1	47nF, X2 CAP
	C13,C8	2	470uF, 35V
	C9,C12,C14	3	100uF, 10V
	C10	1	22uF, 400V
	C11	1	4n7
	C15	1	1uF, 50V
	C16	1	47uF, 16V
	C17,C18	2	100nF
	C19	1	10uF, 16V
Diodes	D1,D2,D11,D13	4	1N4148
	D3	1	UF4001
	D4,D5,D8,D9	4	1N4007
	D10,D6	2	SB540
	D7	1	1N4007GP
	D12	1	UF5400
	D14	1	BZX79C33
Misc	F1	1	200mA, 250Vac
Magnetics	L1	1	4.7uH, 0.2A
	L4,L9	2	4.7uH, 2A
	L5	1	10mH, 0.2A
	L7	1	4.7uH, 0.5A
	T1	1	EF20 Custom
Resistors	R1,R4	2	100R
	R2	1	150k, 1W
	R5,R3	2	1M
	R6	1	3R3
	R7	1	150R
	R8	1	6R8
	R9	1	6k4, 1%
	R10	1	20k, 1%
	R11	1	10k
	R12	1	3k3
R13	1	10k, 1%	
R14	1	275V	
IC's	U1	1	PC817
	U2	1	TOP242P
	U3	1	TL431

Total of 57 components

Notes

- 1) All resistors are 1/8W, 5% unless otherwise specified.

6 Transformer Specification

6.1 Electrical Diagram

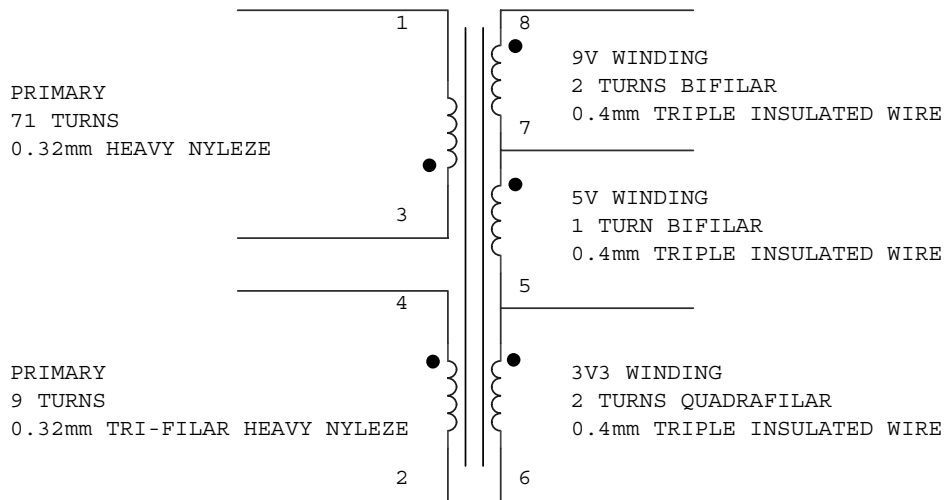

Figure 3 –Transformer Electrical Diagram

6.2 Electrical Specifications

Electrical Strength	1 second, 60 Hz, from pins 1-5 to pins 6-10	3000 VAC
Primary Inductance	Pins 1-4, all other windings open. Measured at 132 kHz, 1 VRMS	1.5mH +15%
Resonant Frequency	Pin 1-4, all other windings open	600 kHz (Min.)
Primary Leakage Inductance	Pins 1-4, with pins 6-10 shorted. Measured at 132 kHz, 1 VRMS	50 μH (Max.)

6.3 Materials

Item	Description
[1]	Core: EF20/10/6, 3C85 or Equivalent, Gapped for AL of 311 nH/T ²
[2]	Bobbin: EF20, 10 Pins
[3]	Magnet Wire: 0.32mm (#28 AWG)
[4]	Triple Insulated Wire : 0.4mm (#26 AWG)
[5]	Tape: 3M 1298 Polyester Film, 12 mm wide
[6]	Varnish

6.4 Transformer Build Diagram

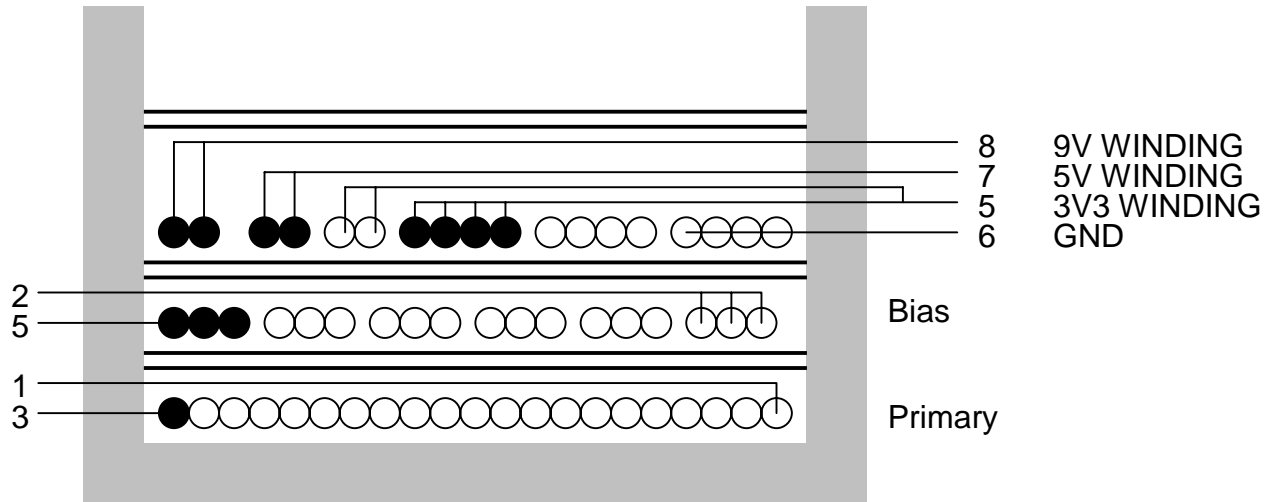

Figure 4 – Transformer Build Diagram

6.5 Winding Instructions

Primary	Start at pin 3. Wind 36 turns of item [3] from left to right in a single layer. Continue from right to left with 35 further turns. Wind tightly and uniformly across entire width of bobbin. Terminate on pin 1.
Insulation	Apply 1 layer of tape item [5] for mechanical fixing
Bias Winding	Start at pin 5. Wind 9 tri-filar turns of item [3] from left to right in a single layer. Finish on pin 2.
Insulation	Apply 3 layers of tape item [5] for mechanical fixing
3V3, 5V and 9V Windings	Start at pin 6. Wind 2 quadrafilar turns of item [4] and terminate on pin 5. Continue with 1 further bifilar turn of item [4] and terminate on pin 7. Finish with 2 further bifilar turns of item [4] and terminate on pin 8. These three windings should occupy a single layer
Outer Insulation	3 Layers of tape [5] for insulation.
Core Assembly	Assemble and secure core halves. Item [1]
Final Varnish	Dip varnish uniformly in item [6]

NOTE: Spreading the 3V, 5V, and 9V windings across the layer, may produce better cross-regulation.

7 Transformer Spreadsheet

Power Supply Input

VACMIN	Volts	195					Min Input AC Voltage
VACMAX	Volts	265					Max Input AC Voltage
FL	Hertz	50					AC Main Frequency
TC	mSeconds	1.68					Bridge Rectifier Conduction Time Estimate
Z		0.66					Loss Allocation Factor
N	%	76.0					Efficiency Estimate

Power Supply Outputs

VOx	Volts		3.30	5.00	9.00	32.00	Output Voltage
IOx	Amps		1.500	1.450	0.050	0.005	Output Current
VB	Volts	15.00					Bias Voltage
IB	Amps	0.006					Bias Current

Device Variables

Device		TOP242P/G					Device Name
PO	Watts	12.90					Total Output Power
VDRAIN	Volts	678					Maximum Drain Voltage Estimate (Includes Effect of Leakage Inductance)
VDS	Volts	5.4					Device On-State Drain to Source Voltage
FS	Hertz	132000					Device Switching Frequency
KRPKDP		1.00					Ripple to Peak Current Ratio
KI		1.00					External Current Limit Ratio
ILIMITEXT	Amps	0.42					Device Current Limit External Minimum
ILIMITMIN	Amps	0.42					Device Current Limit Minimum
ILIMITMAX	Amps	0.48					Device Current Limit Maximum
IP	Amps	0.39					Peak Primary Current
IRMS	Amps	0.14					Primary RMS Current
DMAX		0.37					Maximum Duty Cycle

Power Supply Components Selection

CIN	uFarads	15.0					Input Filter Capacitor
VMIN	Volts	239					Minimum DC Input



							Voltage
VMAX	Volts	375					Maximum DC Input Voltage
VCLO	Volts	200					Clamp Zener Voltage
PZ	Watts	1.7					Estimated Primary Zener Clamp Loss
VDB	Volts	0.7					Bias Winding Diode Forward Voltage Drop
PIVB	Volts	59					Bias Rectifier Maximum Peak Inverse Voltage

Power Supply Output Parameters

VDx	Volts		0.5	0.5	0.5	1.0	Output Winding Diode Forward Voltage Drop
PIVSx	Volts		14	20	35	124	Output Rectifier Maximum Peak Inverse Voltage
ISPx	Amps		4.98	4.82	0.17	0.02	Peak Secondary Current
ISRMSx	Amps		2.29	2.21	0.08	0.01	Secondary RMS Current
IRIPPLEx	Amps		1.73	1.67	0.06	0.01	Output Capacitor RMS Ripple Current

Transformer Construction Parameters

Core/Bobbin		E20/10/6 (EF20) Margi					Core and Bobbin Type
Core Manuf.		Generic					Core Manufacturing
Bobbin Manuf		Generic					Bobbin Manufacturing
LP	uHenries	1571					Primary Inductance
NP		71					Primary Winding Number of Turns
NB		8.26					Bias Winding Number of Turns
OD Actual	mm	0.28					Primary Actual Wire Diameter
Primary Current Density	A/mm ²	2					Primary Winding Current Density Warning! Primary current winding density (A/mm ²) is less than minimum
VOR	Volts	135.00					Reflected Output Voltage
BW	mm	12.50					Bobbin Physical Winding Width
M	mm	0.0					Safety Margin Width
L		2.0					Number of Primary Layers



AE	cm ²	0.32					Core Effective Cross Section Area
ALG	nH/T ²	311					Gapped Core Effective Inductance
BM	mTesla	267					Maximum Operating Flux Density
BP	mTesla	331					Peak Flux Density
BAC	mTesla	134					AC Flux Density for Core Curves
LG	mm	0.11					Gap Length
LL	uHenries	31.4					Estimated Transformer Primary Leakage Inductance
LSEC	nHenries	20					Estimated Secondary Trace Inductance

Secondary Parameters

NSx			2.00	2.89	5.00	17.37	Secondary Number of Turns
Rounded Down NSx				2	5	17	Rounded to Integer Secondary Number of Turns
Rounded Down Vox	Volts			3.27	8.93	31.08	Auxiliary Output Voltage for Rounded to Integer NSx
Rounded Up NSx				3		18	Rounded to Next Integer Secondary Number of Turns
Rounded Up Vox	Volts			5.16		32.96	Auxiliary Output Voltage for Rounded to Next Integer NSx
ODS Actual Range	mm		0.51 - 0.81	0.51 - 0.81	0.09 - 0.14	0.03 - 0.06	Secondary Actual



8 Measurements

All measurements were performed in a lab ambient of 25°C with the unit mounted horizontally in free air.

8.1 Efficiency

Efficiency was measured at the full power condition specified in Table 1. Figure 5 shows the results.

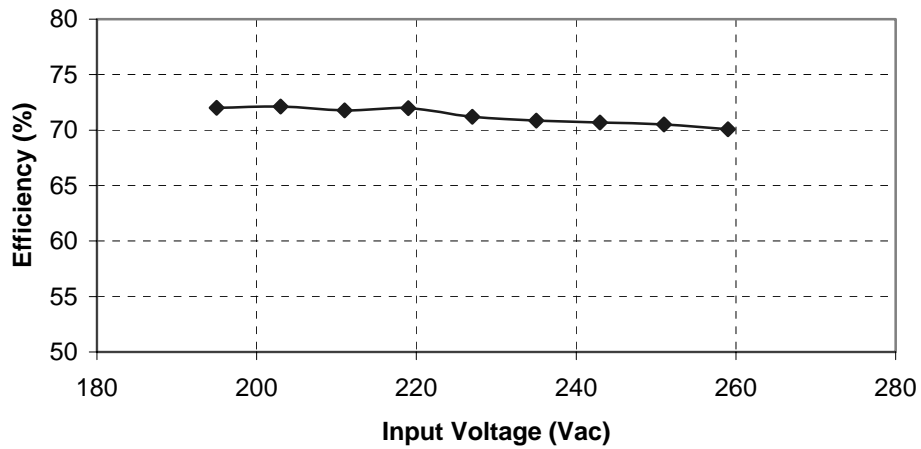

Figure 5 - Full Power Efficiency Variation with Input Voltage

8.2 Line Regulation

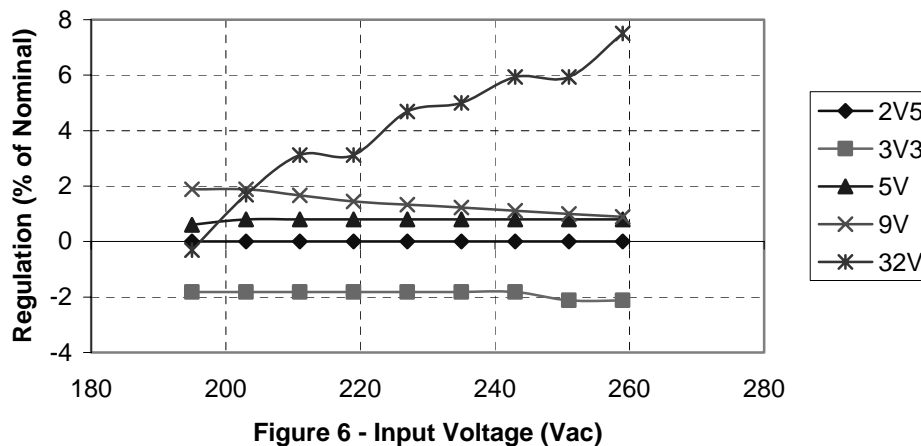

Figure 6 - Input Voltage (Vac)

9 Operating Waveforms

9.1 Output Ripple

For DC output ripple measurements, a modified oscilloscope test probe must be utilized in order to reduce spurious signals due to pickup. Details of the probe modification are provided in Figure 7 and Figure 8.

The 5125BA probe adapter is affixed with two capacitors tied in parallel across the probe tip. The capacitors include one (1) 0.1 $\mu\text{F}/50\text{ V}$ ceramic type and one (1) 1.0 $\mu\text{F}/50\text{ V}$ aluminum electrolytic. ***The aluminum electrolytic type capacitor is polarized, so proper polarity across DC outputs must be maintained (see below).***

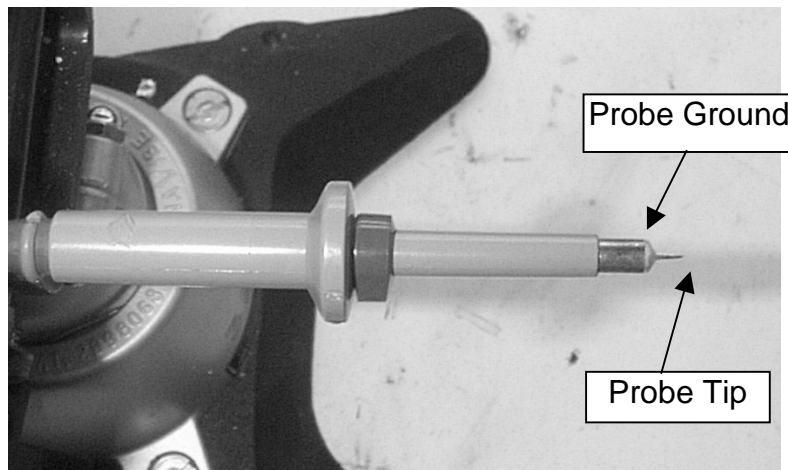

Figure 7 - Oscilloscope Probe Prepared for Ripple Measurement. (End Cap and Ground Lead Removed)

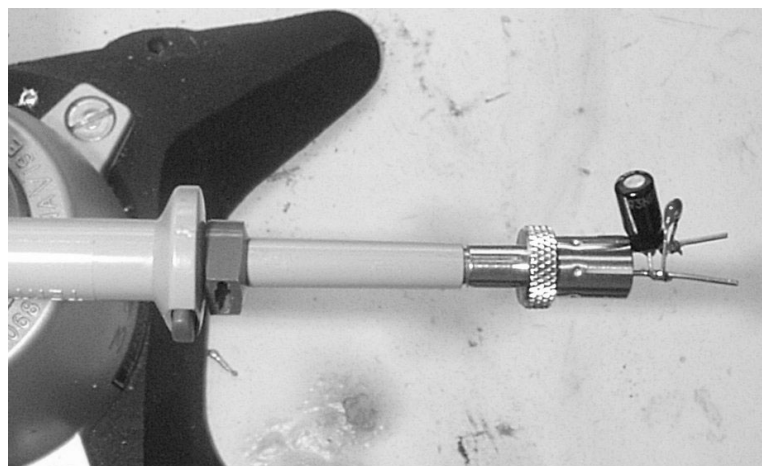

Figure 8 - Oscilloscope Probe with Probe Master 5125BA BNC Adapter. (Modified with wires for probe ground for ripple measurement, and two parallel decoupling capacitors added)

9.1.1 High Frequency Ripple (132kHz)

The post LC filters on each output rail maintain very low high frequency output ripple. Ripple was measured at full power with 230Vac input.

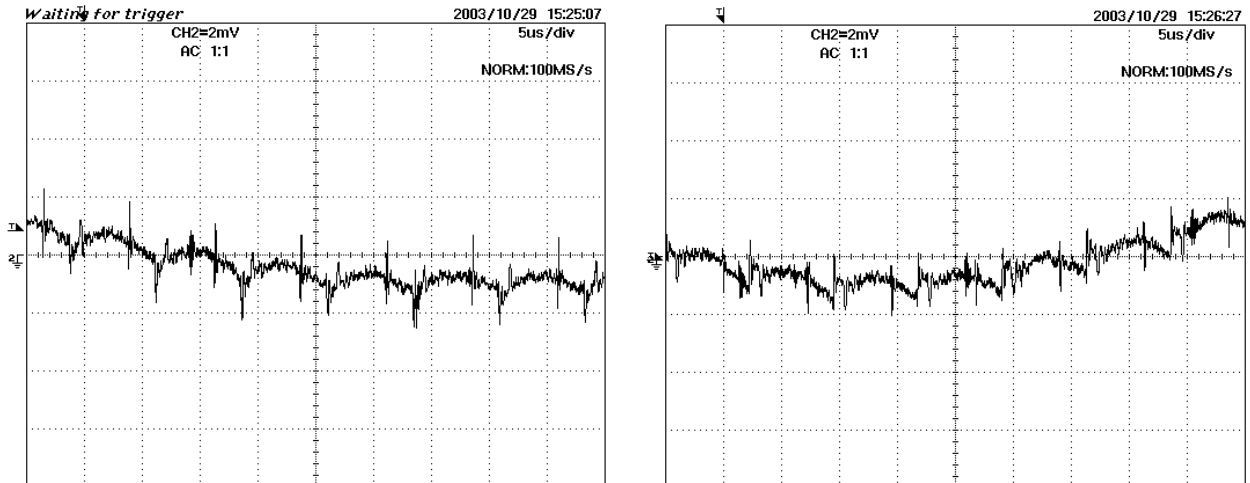

Figure 9 – AC Coupled High Frequency Output Voltage Ripple. Left hand side is 3V3 (2mV/div) and right hand side is 5V (2mV/div).

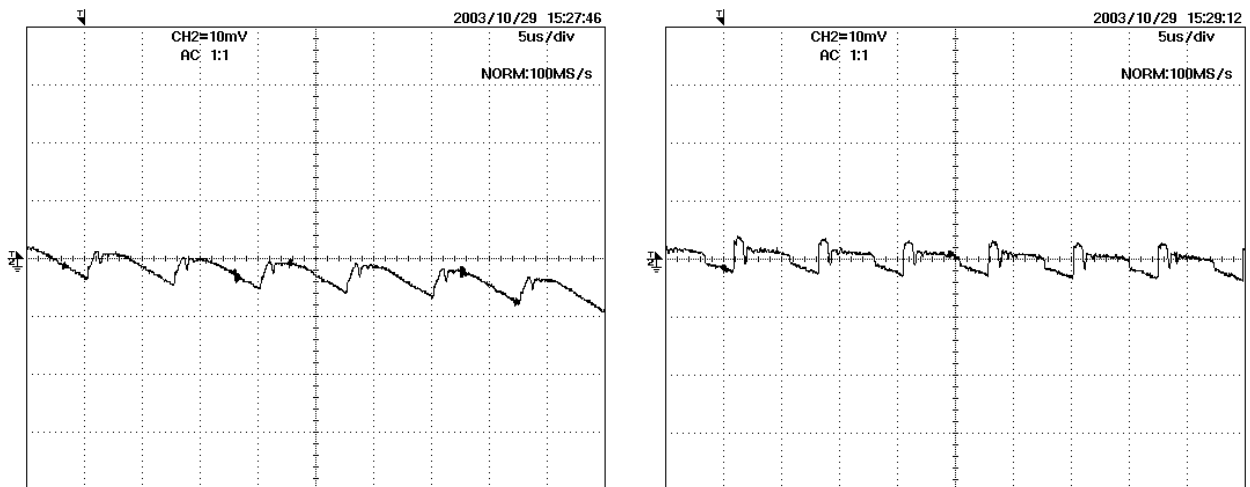

Figure 10 – AC Coupled High Frequency Output Voltage Ripple. Left hand side is 9V (10mV/div) and right hand side is 32V (10mV/div)

The high frequency noise on the 2V5 output is the same as for the 3V3 rail since a single diode is used to drop the output voltage from 3V3 to 2V5.

9.1.2 Low frequency output ripple (100Hz)

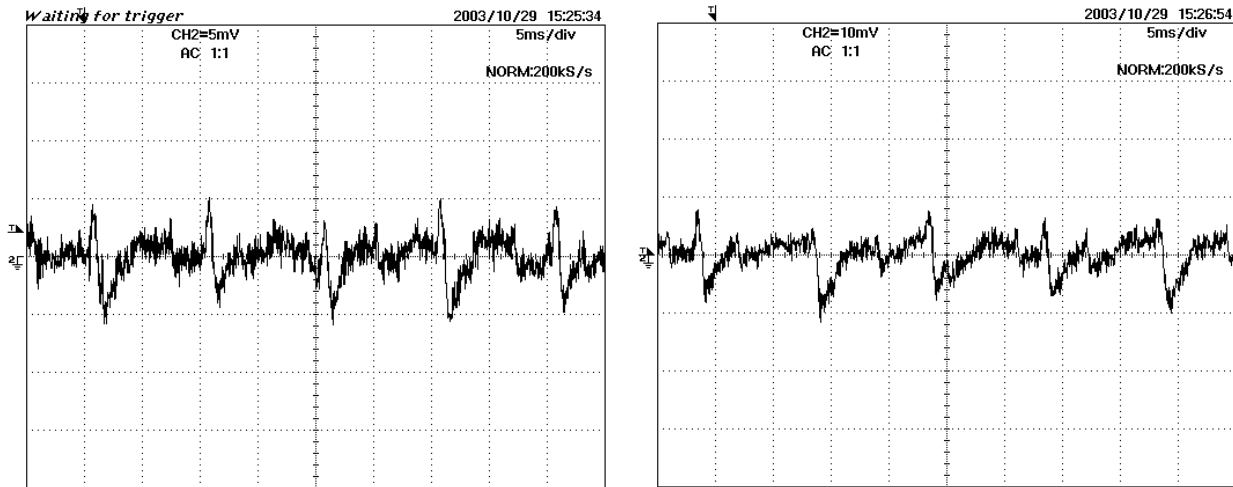

Figure 11 – AC Coupled Low Frequency Output Voltage Ripple. Left hand side is 3V3 (5mV/div) and right hand side is 5V (10mV/div).

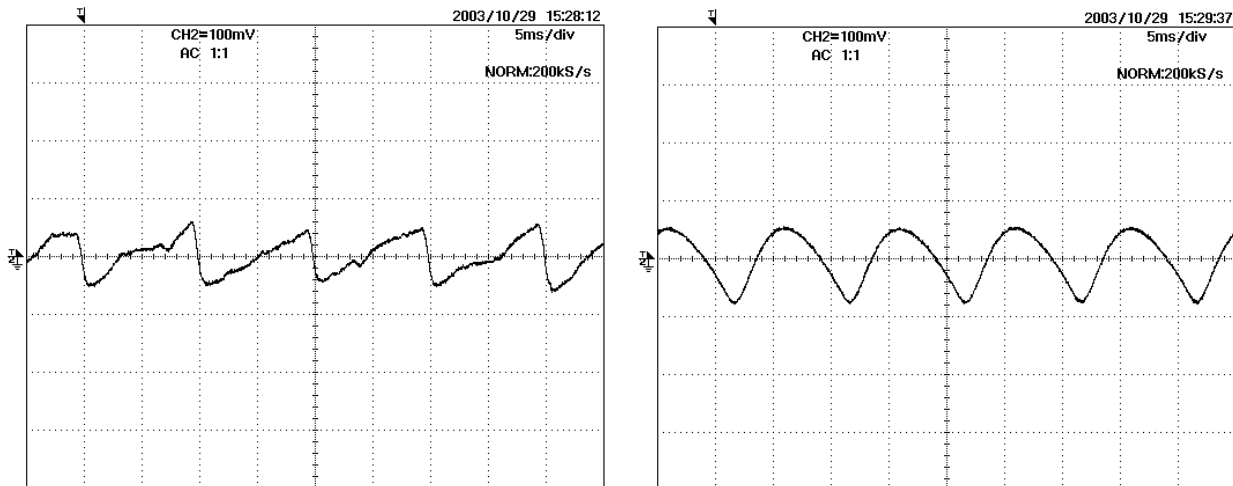

Figure 12 – AC Coupled Low Frequency Output Voltage Ripple. Left hand side is 9V (100mV/div) and right hand side is 32V (100mV/div).



10 Conducted EMI Measurements

The measurements presented in this section are pre-compliance and should only be used for guidance.

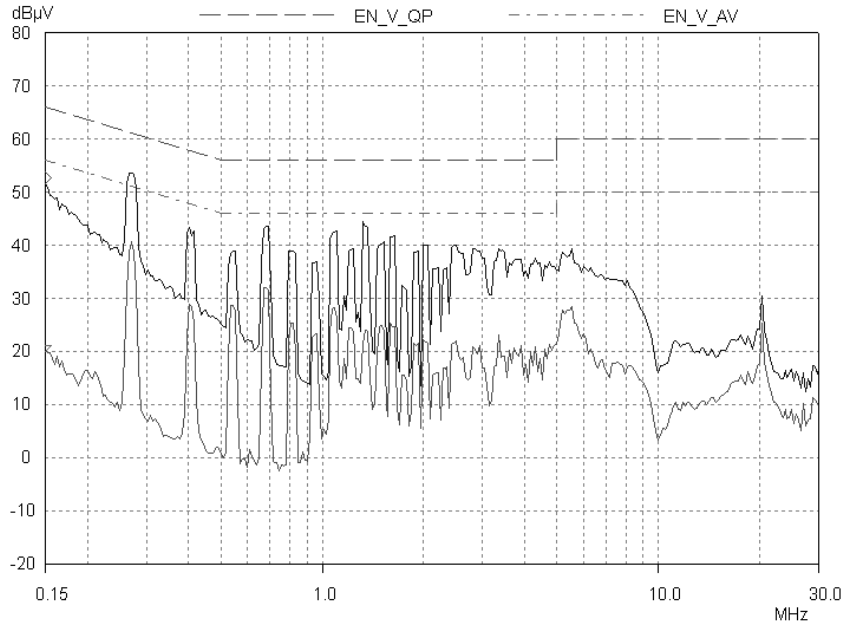

Figure 13 - Conducted EMI with 230Vac input. Full power with the output floating

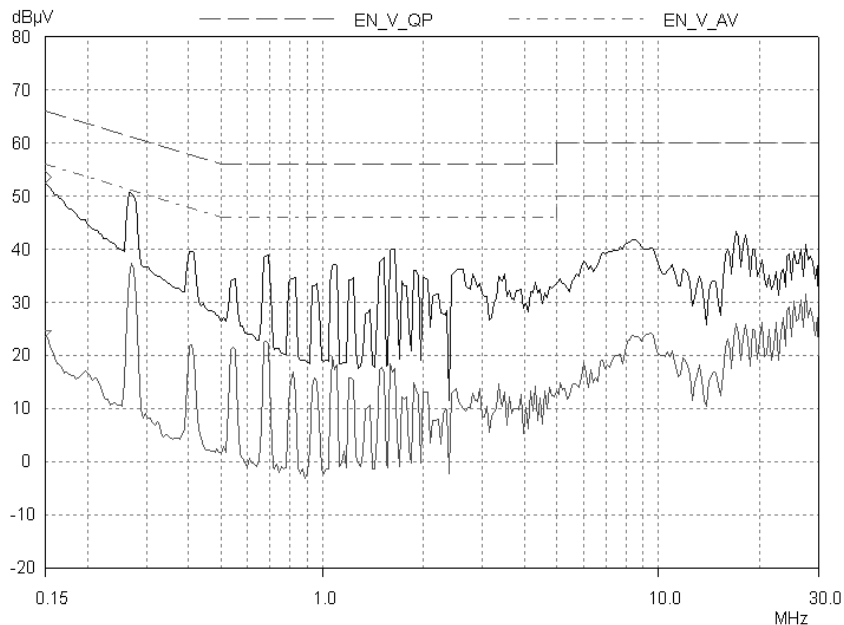

Figure 14 - Conducted EMI with 230Vac input. Full power with the output grounded to Earth

11 Revision History

Date	Author	Revision	Description & changes	Reviewed
April 1, 2004	IM	1.0	Initial release	VC / AM



For the latest updates, visit our Web site: www.powerint.com

Power Integrations reserves the right to make changes to its products at any time to improve reliability or manufacturability. Power Integrations does not assume any liability arising from the use of any device or circuit described herein, nor does it convey any license under its patent rights or the rights of others.

The products and applications illustrated herein (including circuits external to the products and transformer construction) may be covered by one or more U.S. and foreign patents or potentially by pending U.S. and foreign patent applications assigned to Power Integrations. A complete list of Power Integrations' patents may be found at www.powerint.com.

The PI Logo, **TOPSwitch**, **TinySwitch**, **LinkSwitch**, and **EcoSmart** are registered trademarks of Power Integrations, Inc. **PI Expert** and **DPA-Switch** are trademarks of Power Integrations, Inc.
© Copyright 2003, Power Integrations, Inc.

**WORLD HEADQUARTERS
NORTH AMERICA - WEST**
Power Integrations, Inc.
5245 Hellyer Avenue
San Jose, CA 95138 USA.
Main: +1-408-414-9200
Customer Service:
Phone: +1-408-414-9665
Fax: +1-408-414-9765
e-mail:
usasales@powerint.com

CHINA
Power Integrations
International Holdings, Inc.
Rm# 1705, Bao Hua Bldg.
1016 Hua Qiang Bei Lu
Shenzhen Guangdong,
518031
Phone: +86-755-8367-5143
Fax: +86-755-8377-9610
e-mail:
chinasales@powerint.com

APPLICATIONS HOTLINE
World Wide +1-408-414-9660

EUROPE & AFRICA
Power Integrations (Europe) Ltd.
Centennial Court
Easthampstead Road
Bracknell
Berkshire RG12 1YQ,
United Kingdom
Phone: +44-1344-462-300
Fax: +44-1344-311-732
e-mail: eurosales@powerint.com

KOREA
Power Integrations
International Holdings, Inc.
Rm# 402, Handuk Building,
649-4 Yeoksam-Dong,
Kangnam-Gu,
Seoul, Korea
Phone: +82-2-568-7520
Fax: +82-2-568-7474
e-mail: koreasales@powerint.com

APPLICATIONS FAX
World Wide +1-408-414-9760

SINGAPORE
Power Integrations, Singapore
51 Goldhill Plaza #16-05
Republic of Singapore,
308900
Phone: +65-6358-2160
Fax: +65-6358-2015
e-mail:
singaporesales@powerint.com

JAPAN
Power Integrations, K.K.
Keihin-Tatemono 1st Bldg.
12-20 Shin-Yokohama
2-Chome,
Kohoku-ku, Yokohama-shi,
Kanagawa 222-0033, Japan
Phone: +81-45-471-1021
Fax: +81-45-471-3717
e-mail:
japansales@powerint.com

TAIWAN
Power Integrations
International Holdings, Inc.
17F-3, No. 510
Chung Hsiao E. Rd.,
Sec. 5,
Taipei, Taiwan 110, R.O.C.
Phone: +886-2-2727-1221
Fax: +886-2-2727-1223
e-mail:
taiwansales@powerint.com
INDIA (Technical Support)
Innovatech
#1, 8th Main Road
Vasanthnagar
Bangalore, India 560052
Phone: +91-80-226-6023
Fax: +91-80-228-9727
e-mail:
indiasales@powerint.com

