

4N35X, 4N36X, 4N37X,
4N35, 4N36, 4N37,



**OPTICALLY COUPLED
ISOLATOR
PHOTOTRANSISTOR OUTPUT**

APPROVALS

- UL recognised, File No. E91231

'X' SPECIFICATION APPROVALS

- VDE 0884 in 3 available lead forms : -
- STD
- G form
- SMD approved to CECC 00802
- EN60950 approval pending

DESCRIPTION

The 4N35, 4N36, 4N37 series of optically coupled isolators consist of infrared light emitting diode and NPN silicon photo transistor in a standard 6 pin dual in line plastic package.

FEATURES

- Options :-
10mm lead spread - add G after part no.
Surface mount - add SM after part no.
Tape&reel - add SMT&R after part no.
- High Current Transfer Ratio (100% min.)
- High Isolation Voltage (5.3kV_{RMS}, 7.5kV_{PK})
- All electrical parameters 100% tested
- Custom electrical selections available

APPLICATIONS

- DC motor controllers
- Industrial systems controllers
- Measuring instruments
- Signal transmission between systems of different potentials and impedances

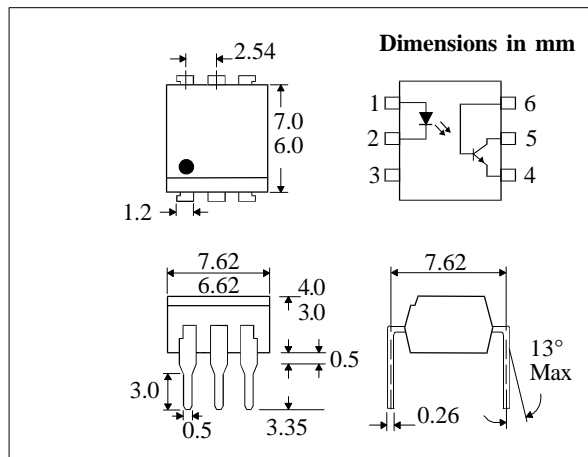
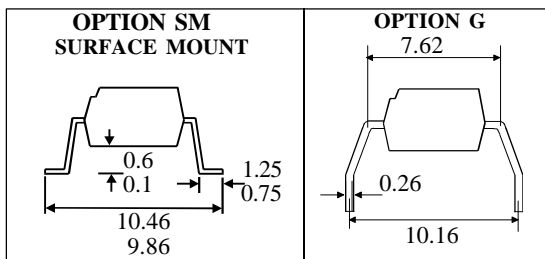

**ABSOLUTE MAXIMUM RATINGS
(25°C unless otherwise specified)**

Storage Temperature _____ -55°C to + 150°C
Operating Temperature _____ -55°C to + 100°C
Lead Soldering Temperature
(1/16 inch (1.6mm) from case for 10 secs) 260°C

INPUT DIODE

Forward Current _____ 60mA
Reverse Voltage _____ 6V
Power Dissipation _____ 105mW

OUTPUT TRANSISTOR

Collector-emitter Voltage BV_{CEO} _____ 30V
Collector-base Voltage BV_{CBO} _____ 70V
Emitter-collector Voltage BV_{ECO} _____ 6V
Power Dissipation _____ 160mW

POWER DISSIPATION

Total Power Dissipation _____ 200mW
(derate linearly 2.67mW/°C above 25°C)

ISOCOM COMPONENTS LTD
Unit 25B, Park View Road West,
Park View Industrial Estate, Brenda Road
Hartlepool, Cleveland, TS25 1YD
Tel: (01429) 863609 Fax : (01429) 863581

ISOCOM INC
1024 S. Greenville Ave, Suite 240,
Allen, TX 75002 USA
Tel: (214) 495-0755 Fax: (214) 495-0901
e-mail info@isocom.com
http://www.isocom.com

ELECTRICAL CHARACTERISTICS ($T_A = 25^\circ\text{C}$ Unless otherwise noted)

PARAMETER		MIN	TYP	MAX	UNITS	TEST CONDITION
Input	Forward Voltage (V_F)		1.2	1.5	V	$I_F = 10\text{mA}$ $I_R = 10\mu\text{A}$ $V_R = 6\text{V}$
	Reverse Voltage (V_R)	6			V	
	Reverse Current (I_R)			10	μA	
Output	Collector-emitter Breakdown (BV_{CEO}) (Note 2)	30			V	$I_C = 1\text{mA}$
	Collector-base Breakdown (BV_{CBO})	70			V	$I_C = 100\mu\text{A}$
	Emitter-collector Breakdown (BV_{ECO})	6			V	$I_E = 100\mu\text{A}$
	Collector-emitter Dark Current (I_{CEO})			50	nA	$V_{CE} = 10\text{V}$
	Collector-base Dark Current (I_{CBO})			20	nA	$V_{CE} = 10\text{V}$
Coupled	Current Transfer Ratio (CTR)	100			%	$10\text{mA } I_F, 10\text{V } V_{CE}$
	Collector-emitter Saturation Voltage $V_{CE(SAT)}$			0.3	V	$10\text{mA } I_F, 0.5\text{mA } I_C$
	Input to Output Isolation Voltage V_{ISO}	5300			V_{RMS}	See note 1
		7500			V_{PK}	See note 1
	Input-output Isolation Resistance R_{ISO}	5×10^{10}			Ω	$V_{IO} = 500\text{V}$ (note 1)
	Turn-on Time t_{on}		5	10	μs	$V_{CC} = 10\text{V},$ $I_C = 2\text{mA}, R_L = 100\Omega$ (FIG 1)
	Turn-off Time t_{off}		5	10	μs	
Output Rise Time t_r		3.5		μs		
Output Fall Time t_f		4.9		μs		

Note 1 Measured with input leads shorted together and output leads shorted together.

Note 2 Special Selections are available on request. Please consult the factory.

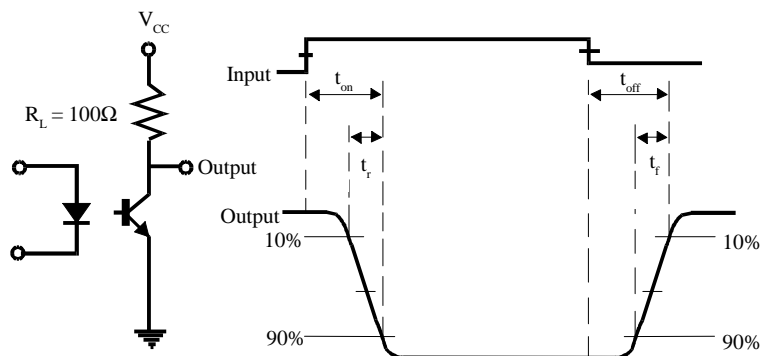
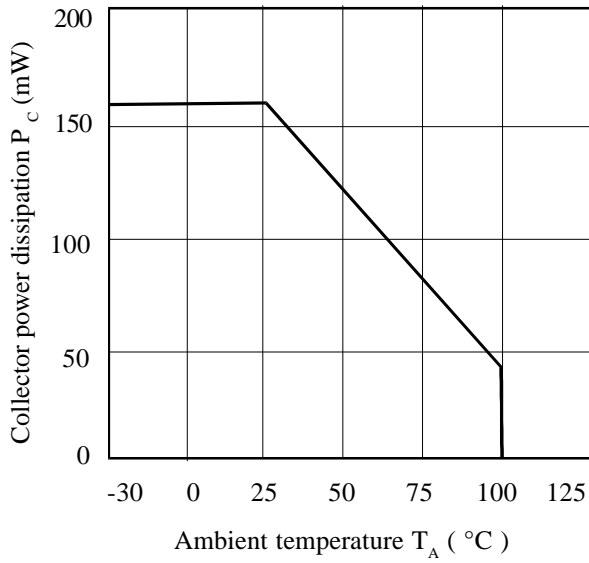
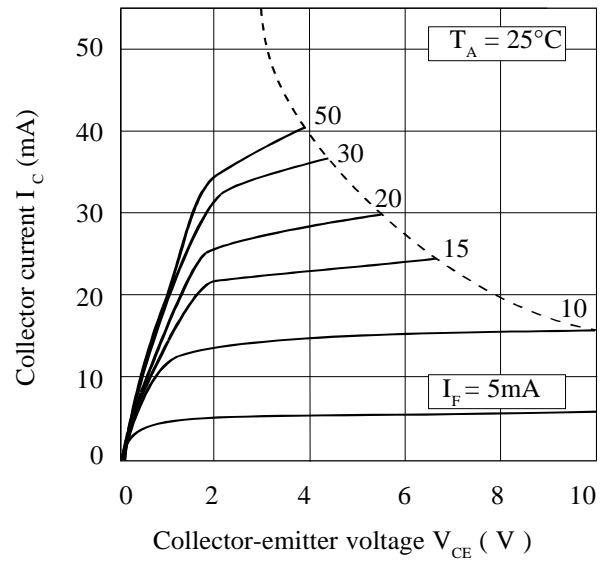

FIG 1

Collector Power Dissipation vs. Ambient Temperature



Collector Current vs. Collector-emitter Voltage



Forward Current vs. Ambient Temperature

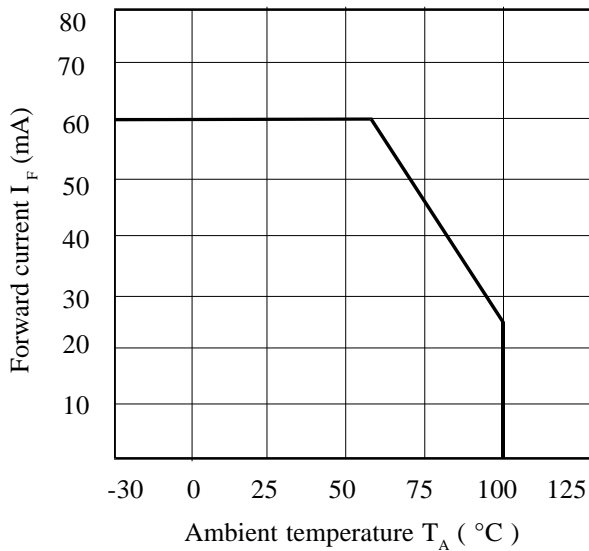

Collector-emitter Saturation Voltage vs. Ambient Temperature

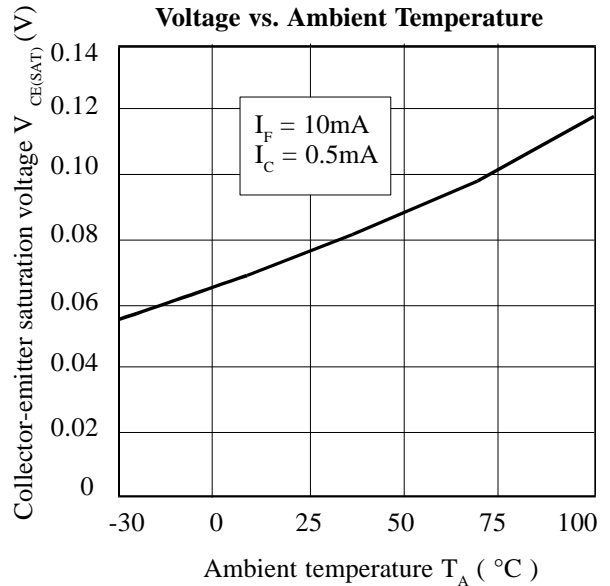

Relative Current Transfer Ratio vs. Ambient Temperature

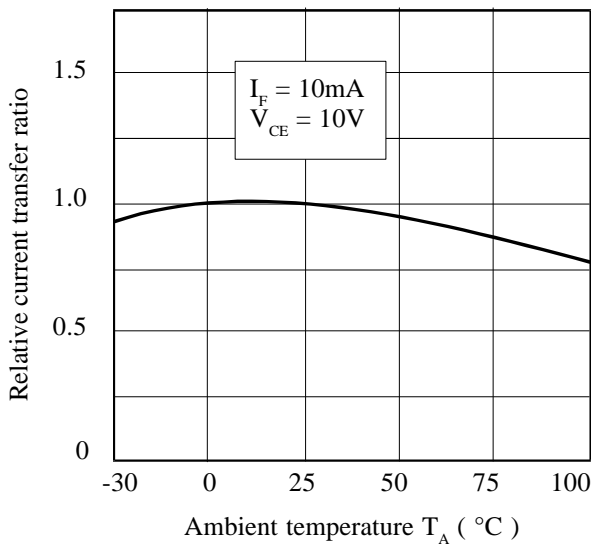

Relative Current Transfer Ratio vs. Forward Current

