

PTF 10036

85 Watts, 860–960 MHz

GOLDMOS™ Field Effect Transistor

Description

The PTF 10036 is an internally matched, 85 Watt LDMOS FET intended for large signal amplifier applications from 860 to 960 MHz. Nitride surface passivation and full gold metallization ensure excellent device lifetime and reliability.

- **INTERNALLY MATCHED**
- **Performance at 960 MHz, 28 Volts**
 - Output Power = 85 Watts
 - Power Gain = 12.5 dB Typ
 - Efficiency = 55% Typ
- **Full Gold Metallization**
- **Silicon Nitride Passivated**
- **Back Side Common Source**
- **100% Lot Traceability**

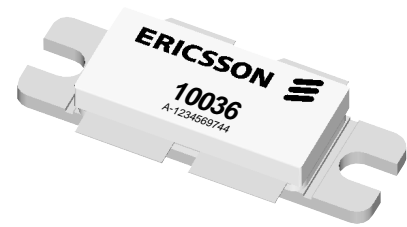
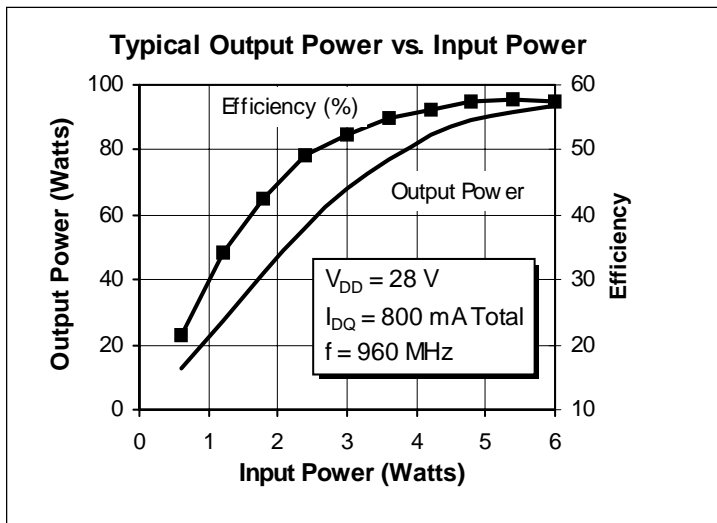

Package 20240

RF Specifications (100% Tested)

Characteristic	Symbol	Min	Typ	Max	Units
Gain ($V_{DD} = 28\text{ V}$, $P_{OUT} = 85\text{ W}$, $I_{DQ} = 800\text{ mA Total}$, $f = 900\text{ MHz}$)	G_{ps}	11.0	12.5	—	dB
Power Output at 1 dB Compression ($V_{DD} = 28\text{ V}$, $I_{DQ} = 800\text{ mA Total}$, $f = 900\text{ MHz}$)	P-1dB	85	90	—	Watts
Drain Efficiency ($V_{DD} = 28\text{ V}$, $P_{OUT} = 85\text{ W}$, $I_{DQ} = 800\text{ mA Total}$, $f = 900\text{ MHz}$)	η	50	55	—	%
Load Mismatch Tolerance ($V_{DD} = 28\text{ V}$, $P_{OUT} = 85\text{ W(PEP)}$, $I_{DQ} = 800\text{ mA Total}$, $f = 867, 867.1\text{ MHz}$ —all phase angles at frequency of test)	Ψ	—	—	3:1	—

All published data at $T_{CASE} = 25^\circ\text{C}$ unless otherwise indicated.

Electrical Characteristics (100% Tested—characteristics, conditions and limits shown per side)

Characteristic	Conditions	Symbol	Min	Typ	Max	Units
Drain-Source Breakdown Voltage	$V_{GS} = 0\text{ V}, I_D = 5\text{ mA}$	$V_{(BR)DSS}$	65	—	—	Volts
Drain-Source Leakage Current	$V_{DS} = 28\text{ V}, V_{GS} = 0\text{ V}$	I_{DSS}	—	—	1.0	mA
Gate Threshold Voltage	$V_{DS} = 10\text{ V}, I_D = 75\text{ mA}$	$V_{GS(th)}$	3.0	—	5.0	Volts
Forward Transconductance	$V_{DS} = 10\text{ V}, I_D = 3\text{ A}$	g_{fs}	—	2.8	—	Siemens

Maximum Ratings

Parameter	Symbol	Value	Unit
Drain-Source Voltage ⁽¹⁾	V_{DSS}	65	Vdc
Gate-Source Voltage ⁽¹⁾	V_{GS}	± 20	Vdc
Operating Junction Temperature	T_J	200	°C
Total Device Dissipation at Above 25°C derate by	P_D	250 1.43	Watts W/°C
Storage Temperature Range	T_{STG}	-40 to +150	°C
Thermal Resistance ($T_{CASE} = 70^\circ\text{C}$)	$R_{\theta JC}$	0.7	°C/W

⁽¹⁾ per side

Typical Performance

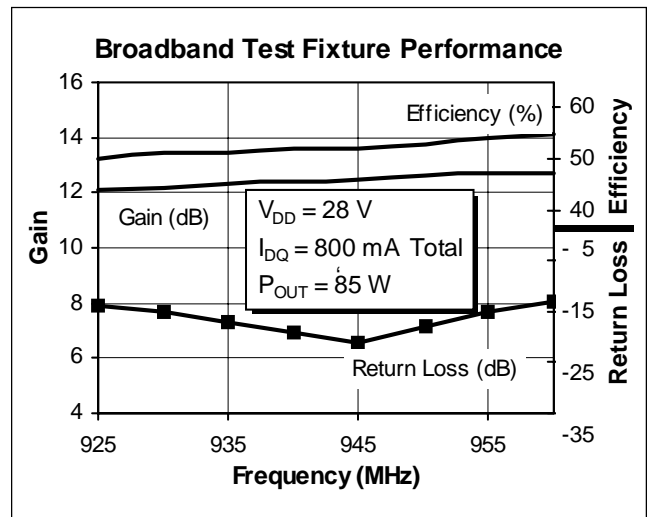
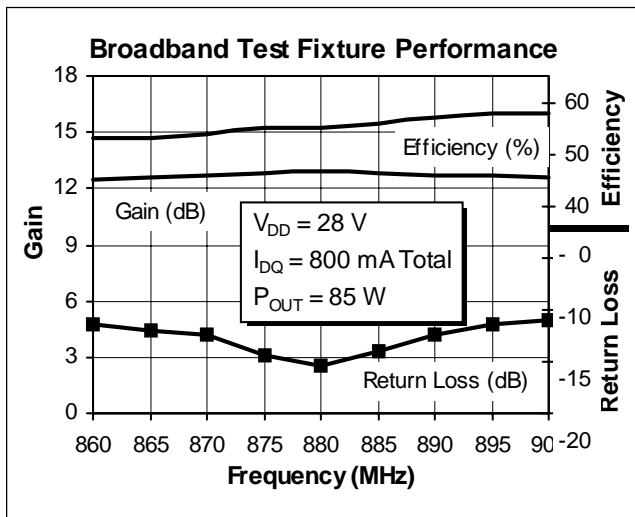

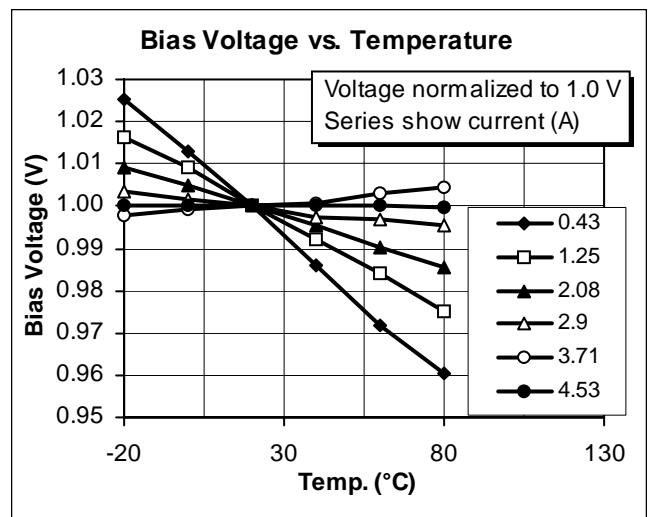
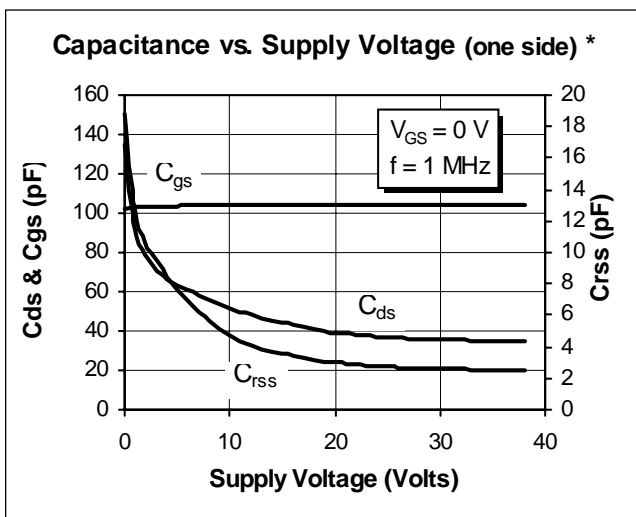
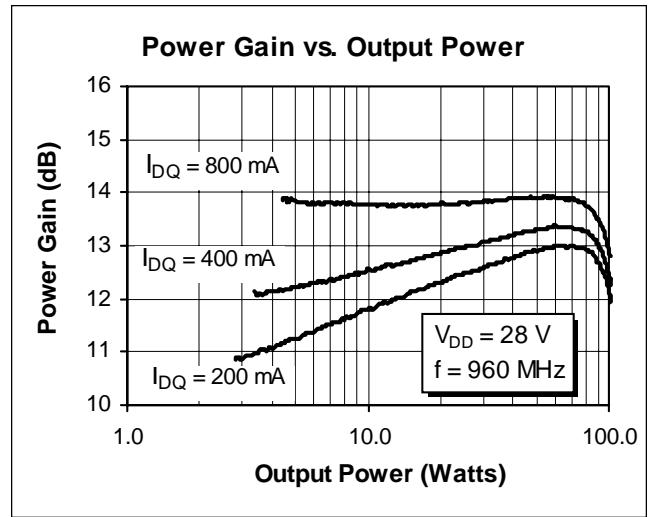
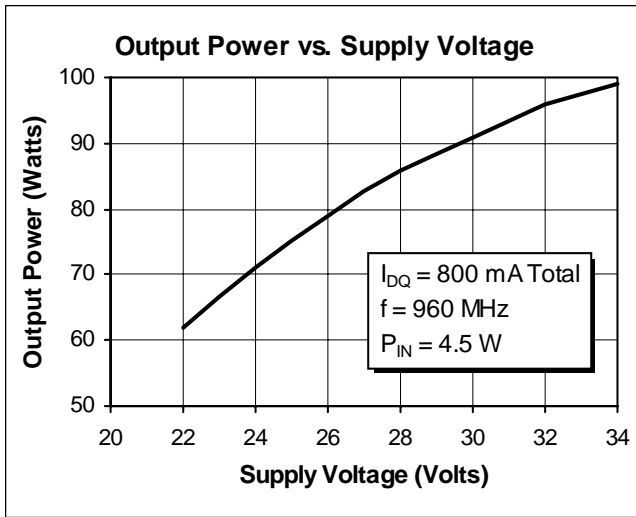
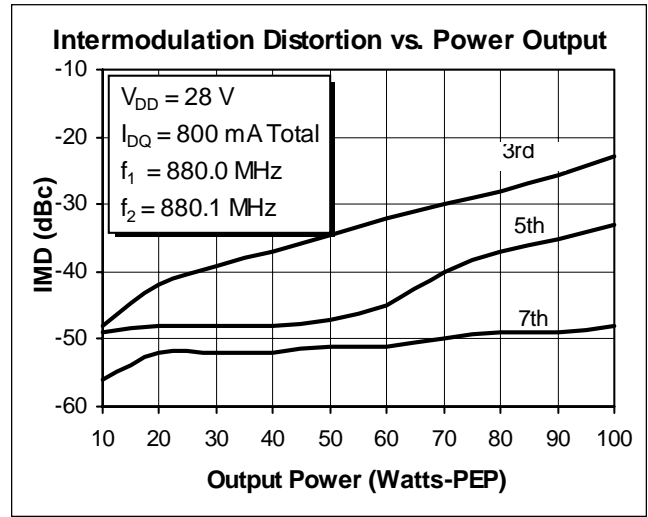
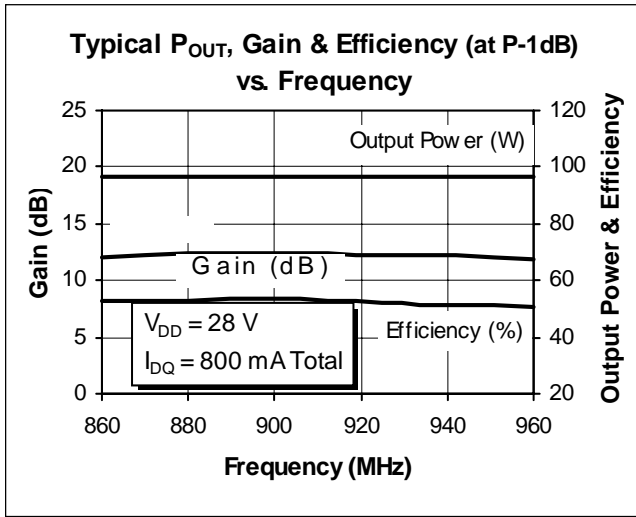

* This part is internally matched. Measurements of the finished product will not yield these results.

PTF 10036



Impedance Data

$V_{DD} = 28\text{ V}$, $P_{OUT} = 85\text{ W}$, $I_{DQ} = 800\text{ mA Total}$

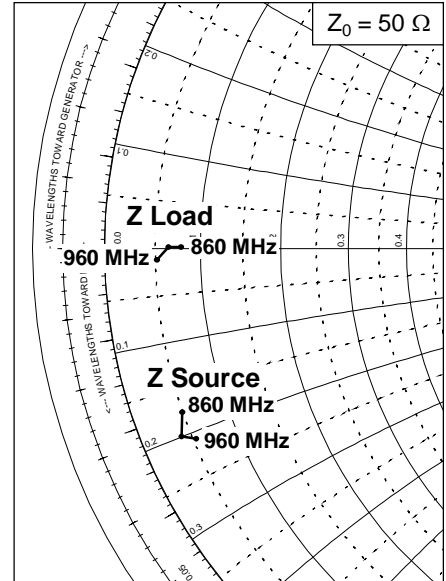
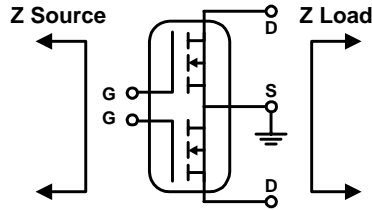

Frequency MHz	Z Source Ω		Z Load Ω	
	R	jX	R	jX
860	2.5	-8.8	3.9	0.1
900	2.0	-10.0	3.2	0.1
960	2.7	-10.4	2.6	-0.6

Typical Scattering Parameters (one side only)

($V_{DS} = 28\text{ V}$, $I_D = 1.5\text{ A}$)

f (MHz)	S11		S21		S12		S22	
	Mag	Ang	Mag	Ang	Mag	Ang	Mag	Ang
100	0.913	-167.7	11.706	62.7	0.008	-21.5	0.605	-126.8
150	0.934	-171.3	6.956	47.4	0.007	-31.1	0.725	-136.6
200	0.950	-173.4	4.507	37.7	0.006	-38.4	0.799	-143.5
250	0.962	-175.0	3.257	29.4	0.005	-43.8	0.873	-148.7
300	0.968	-176.4	2.413	22.8	0.004	-42.4	0.887	-153.0
350	0.971	-177.6	1.905	18.3	0.003	-35.6	0.922	-156.1
400	0.974	-178.6	1.555	13.2	0.002	-30.6	0.943	-158.9
450	0.975	-179.6	1.297	10.4	0.002	-11.8	0.943	-160.6
500	0.976	179.4	1.117	6.5	0.001	7.4	0.961	-162.6
550	0.976	178.4	0.978	3.6	0.002	24.6	0.960	-164.0
600	0.975	177.4	0.881	0.9	0.002	49.2	0.960	-165.1
650	0.975	176.6	0.801	-1.8	0.002	58.7	0.969	-166.6
700	0.972	175.7	0.750	-3.8	0.003	65.0	0.962	-167.1
750	0.971	174.6	0.713	-6.0	0.004	67.9	0.967	-168.3
800	0.968	173.3	0.688	-8.6	0.005	66.2	0.970	-169.0
850	0.968	172.4	0.677	-10.9	0.005	71.8	0.962	-169.4
900	0.962	171.0	0.686	-13.6	0.006	71.3	0.965	-170.5
950	0.956	169.6	0.704	-17.3	0.007	69.6	0.966	-170.8
1000	0.945	167.8	0.750	-21.4	0.008	67.1	0.962	-171.0
1050	0.926	165.7	0.819	-27.7	0.009	64.8	0.961	-171.9
1100	0.887	163.0	0.938	-36.3	0.011	57.6	0.964	-171.6
1150	0.803	160.6	1.128	-51.8	0.013	46.6	0.965	-171.4
1200	0.662	164.4	1.299	-77.1	0.014	27.1	0.981	-171.8
1250	0.659	-178.9	1.183	-109.8	0.012	-0.2	1.006	-172.1
1300	0.803	-174.8	0.856	-136.0	0.007	-16.6	1.008	-173.7
1350	0.897	-177.2	0.587	-151.8	0.004	-14.3	1.004	-175.0
1400	0.938	-179.7	0.416	-161.0	0.002	13.8	1.005	-175.1
1450	0.963	178.1	0.315	-169.1	0.003	50.8	0.996	-176.2
1500	0.977	176.3	0.238	-174.6	0.003	60.3	1.000	-176.4

Test Circuit

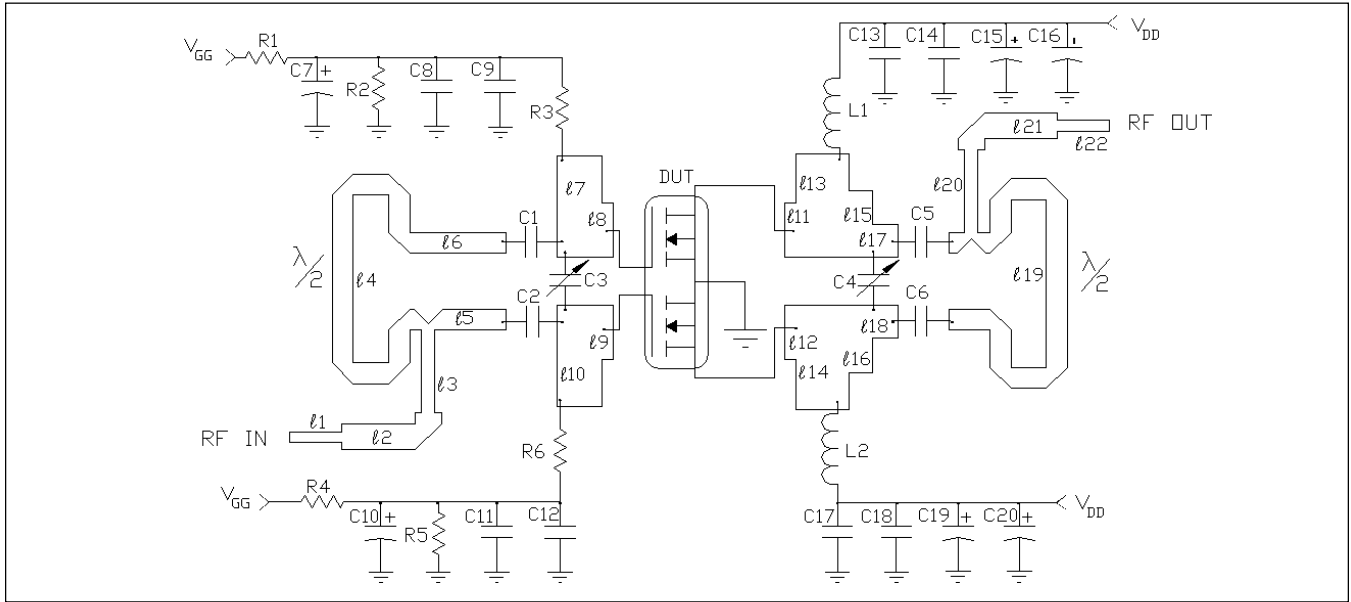

Schematic for f = 900 MHz

- DUT PTF 10036
- C1-2 15 pF, Capacitor ATC 100 B
- C3 0.35–3.5 pF, Variable Capacitor
- C4 1–9 pF, Variable Capacitor
- C5-6, C9, C12-13, C17 33 pF, Capacitor ATC 100 B
- C7, C10 10 μF, +10 V Electrolytic Capacitor
- C8, C11, C14, C18 0.01 μF, Capacitor ATC 100 B
- C15, C16, C19, C20 10 μF, +30 V Electrolytic Capacitor
- L1, L2 4 Turn, #20 AWG, .120" I.D.
- R1, R2, R4, R5 1.0 K, Ω Resistor
- R3, R6 5.1 K, 1/4 Ω Resistor
- l1, l22 50 Ω, .030 λ

- l2, l21 20 Ω, .080 λ
- l3, l20 32 Ω, .191 λ
- l4, l19 25 Ω, .500 λ
- l5, l6 25 Ω, .091 λ
- l7, l10 7 Ω, .056 λ
- l8, l9 13.0 Ω, .017 λ
- l11, l12 13.0 Ω, .017 λ
- l13, l14 7.0 Ω, .064 λ
- l15, l16 10.0 Ω, .029 λ
- l17, l18 19.0 Ω, .028 λ
- Circuit Board .028" Dielectric Thickness, ε_r = 4.0, AlliedSignal, G200, 2 oz. copper

Components Layout (not to scale)

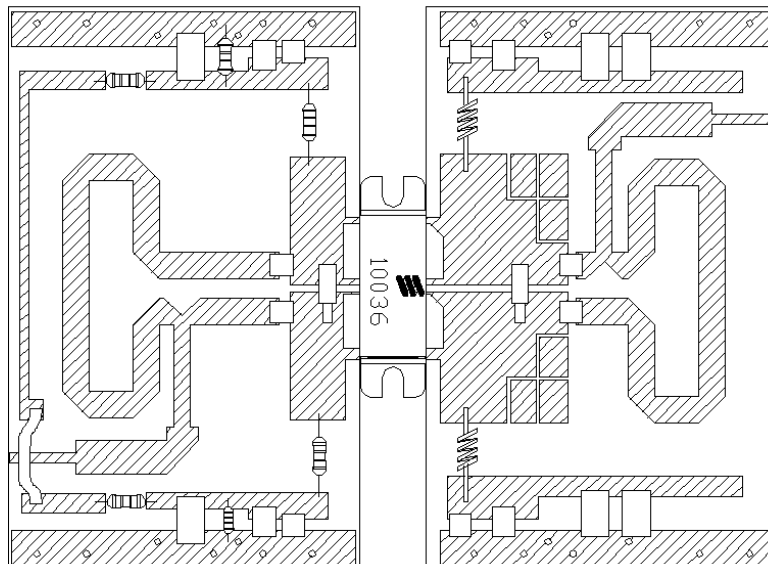

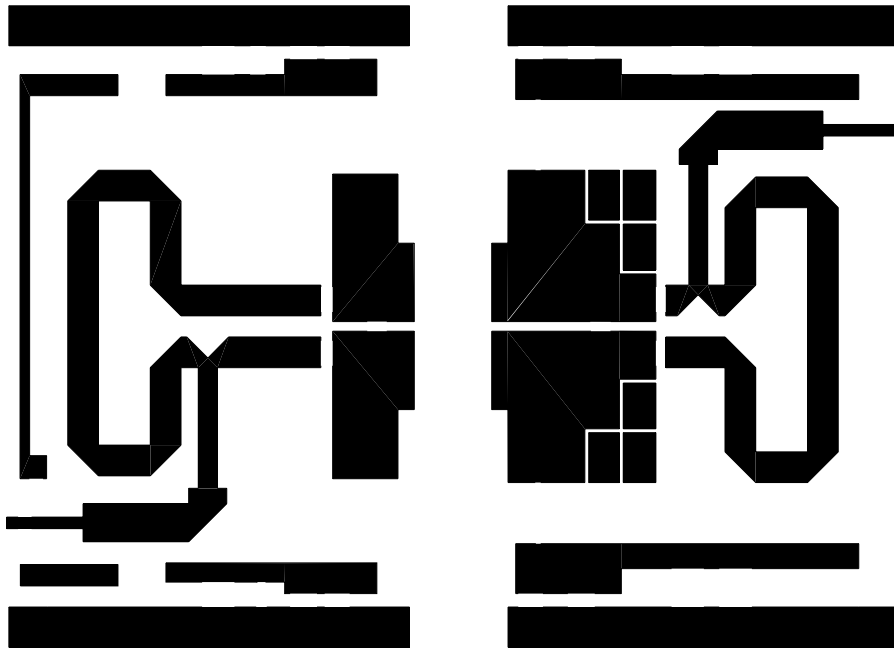

Artwork (1 inch )