

# PM15CTM060-3

FLAT-BASE TYPE  
INSULATED PACKAGE

## PM15CTM060-3

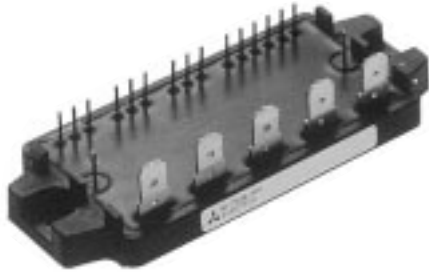

- 600V, 15A Current-sense 6kHz IGBT type inverter
- Built in IGBT gate drive circuit
- Built in Fault OC, SC, OT & UV protection Fault output
- 0.75kW class inverter application
- UL Recognized

Yellow Card No. E80276 (N)  
File No. E80271

## APPLICATION

Air conditioner, motor control

## OUTLINE DRAWING

Dimensions in mm

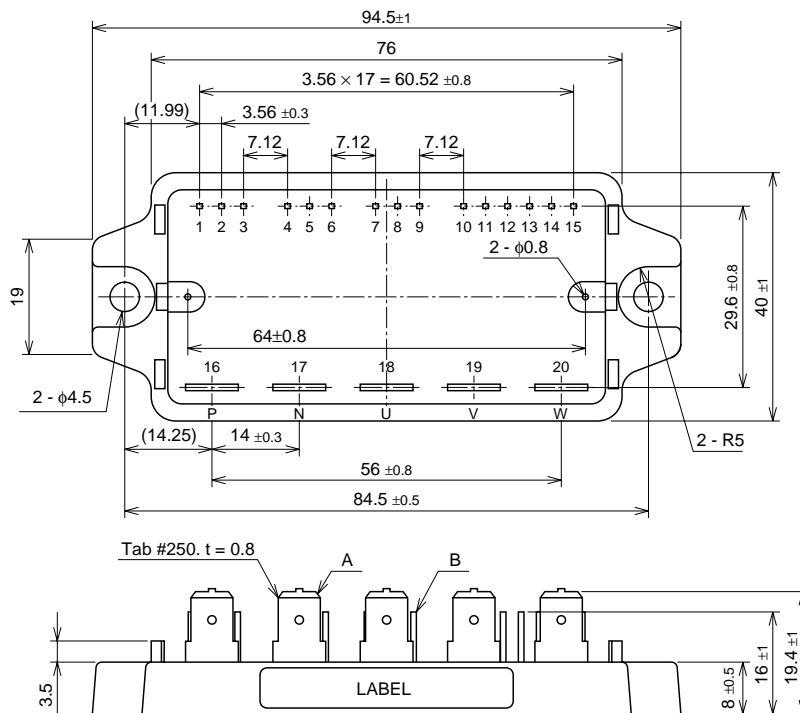

### A - B: TERMINAL NAME

1.	VUPC	11.	VN1
2.	UP	12.	UN
3.	VUP1	13.	VN
4.	VVPC	14.	WN
5.	VP	15.	FO
6.	VVP1	16.	P
7.	VWPC	17.	N
8.	WP	18.	U
9.	VWP1	19.	V
10.	VNC	20.	W

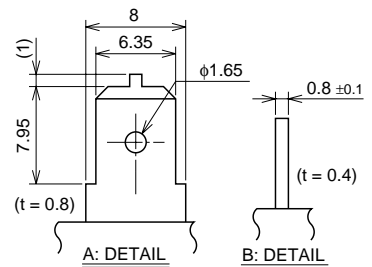
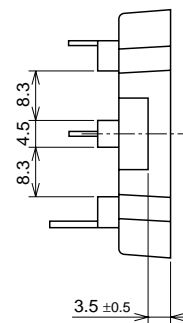

**PM15CTM060-3**

FLAT-BASE TYPE  
INSULATED PACKAGE

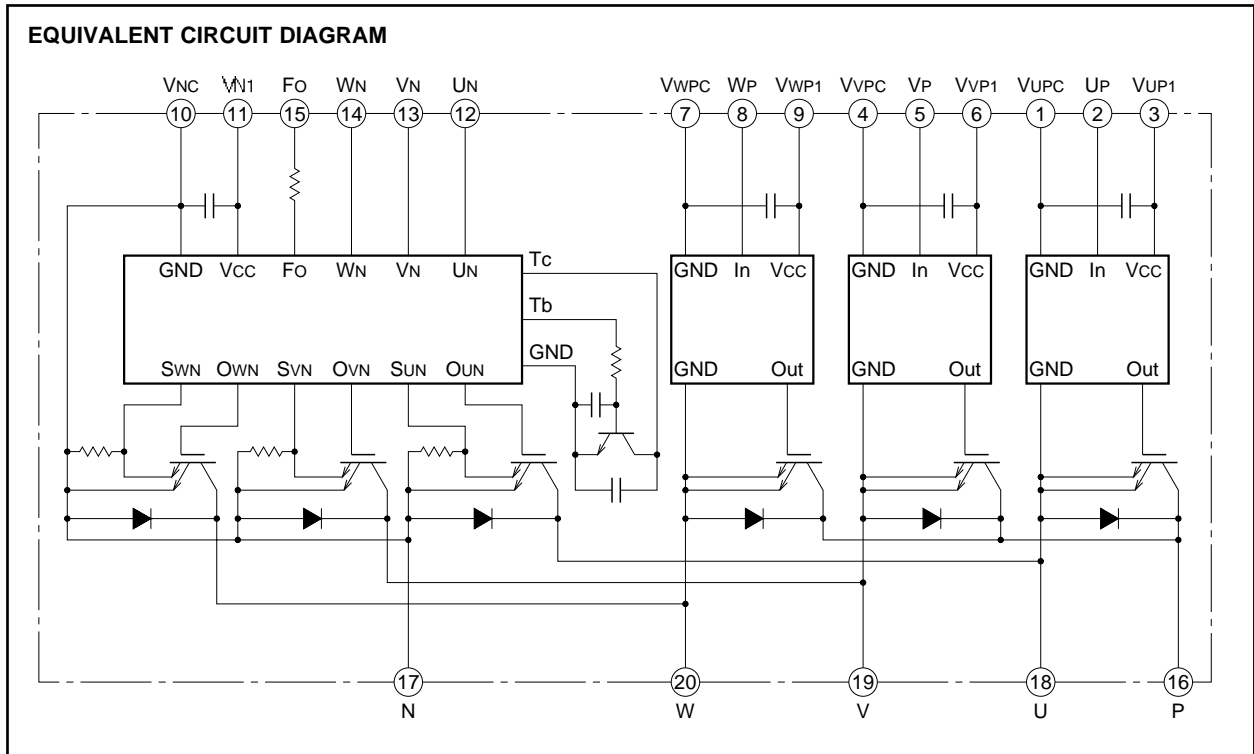

**MAXIMUM RATINGS** ( $T_j = 25^\circ\text{C}$ , unless otherwise noted)

**INVERTER PART**

Symbol	Parameter	Conditions	Ratings	Unit
$V_{CES}$	Collector-emitter voltage	$V_D = 15\text{V}$ , $I_{CIN} = 10\text{mA}$	600	V
$\pm I_C$	Collector current	$T_C = 25^\circ\text{C}$	15	A
$\pm I_{CP}$	Collector current (peak)	$T_C = 25^\circ\text{C}$	30	A
$P_C$	Collector dissipation	$T_C = 25^\circ\text{C}$	43	W
$T_j$	Junction temperature		$-20 \sim +125^*$	$^\circ\text{C}$

\* maximum instantaneous  $T_j \leq 150^\circ\text{C}$

**CONTROL PART**

Symbol	Parameter	Conditions	Ratings	Unit
$V_D$	Supply voltage	Applied between : $V_{UP1}-V_{UPC}$ , $V_{VP1}-V_{VPC}$ $V_{WP1}-V_{WPC}$ , $V_{N1}-V_{NC}$	20	V
$I_{CIN}$	Input current	Applied between : $U_P-V_{UPC}$ , $V_P-V_{VPC}$ , $W_P-V_{WPC}$ , $U_N \cdot V_N \cdot W_N-V_{NC}$	20	mA
$V_{FO}$	Fault output supply voltage	Applied between : $FO-V_{NC}$	20	V
$I_{FO}$	Fault output current	Sink current of $FO$ terminal	20	mA

**PM15CTM060-3**

FLAT-BASE TYPE  
INSULATED PACKAGE

**TOTAL SYSTEM**

Symbol	Parameter	Conditions	Ratings	Unit
V <sub>CC(PROT)</sub>	Supply voltage protected by OC & SC	V <sub>D</sub> = 13.5 ~ 16.5V, Inverter part, T <sub>j</sub> = 125°C start	400	V
V <sub>CC</sub>	Supply voltage	Applied between : P-N, operating time	450	V
V <sub>CC(surge)</sub>	Supply voltage (surge)	Applied between : P-N, surge and non-operating time	500	V
T <sub>C</sub>	Module case operating temperature	(Note 1)	-20 ~ +100	°C
T <sub>stg</sub>	Storage temperature		-40 ~ +125	°C
V <sub>iso</sub>	Isolation voltage	60Hz, sinusoidal, AC · 1 min	2500	V <sub>rms</sub>

Note 1 : T<sub>C</sub> measuring point is as shown below.

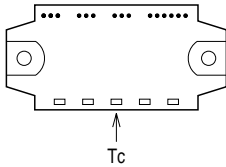

**ELECTRICAL CHARACTERISTICS** (T<sub>j</sub> = 25°C, unless otherwise noted)

**INVERTER PART**

Symbol	Parameter	Test conditions	Limits			Unit	
			Min.	Typ.	Max.		
V <sub>CE(sat)</sub>	Collector-emitter saturation voltage	V <sub>D</sub> = 15V, I <sub>CIN</sub> = 10mA	I <sub>C</sub> = 15A, T <sub>j</sub> = 25°C	—	1.8	2.6	V
			I <sub>C</sub> = 15A, T <sub>j</sub> = 125°C	—	2.0	3.0	
V <sub>EC</sub>	FWDi forward voltage	-I <sub>C</sub> = 15A, V <sub>D</sub> = 15V, I <sub>CIN</sub> = 0mA	—	2.0	3.0	V	
t <sub>on</sub>	Switching time	V <sub>D</sub> = 15V, I <sub>CIN</sub> = 0mA↔10mA V <sub>CC</sub> = 300V, I <sub>C</sub> = 15A T <sub>j</sub> = 125°C (Per 1 arm) Inductive Load	0.5	1.0	2.0	μs	
t <sub>rr</sub>			—	0.1	—	μs	
t <sub>c(on)</sub>			—	0.2	0.8	μs	
t <sub>off</sub>			—	2.5	3.5	μs	
t <sub>c(off)</sub>			—	0.9	2.0	μs	
I <sub>CES</sub>	Collector-emitter cutoff current	V <sub>CE</sub> = V <sub>CEs</sub> , I <sub>CIN</sub> = 0mA	T <sub>j</sub> = 25°C	—	—	1	mA
			T <sub>j</sub> = 125°C	—	—	10	

**CONTROL PART**

Symbol	Parameter	Test conditions	Limits			Unit	
			Min.	Typ.	Max.		
I <sub>D</sub>	Circuit current	V <sub>D</sub> = 15V, I <sub>CIN</sub> = 0mA	V <sub>N1</sub> -V <sub>Nc</sub>	—	25	35	mA
			V <sub>XP1</sub> -V <sub>XPC</sub>	—	5	10	
I <sub>th(ON)</sub>	Input on threshold current	Applied between : UP-VU <sub>PC</sub> , VP-VV <sub>PC</sub> , WP-VW <sub>PC</sub>	1	3	5	mA	
I <sub>th(OFF)</sub>	Input off threshold current	UN · V <sub>N</sub> · WN-V <sub>Nc</sub>	1	3	5	mA	
OC	Over current trip level	-20°C ≤ T <sub>j</sub> ≤ 125°C, V <sub>D</sub> = 15V (only N side)	18	23	—	A	
SC	Short circuit trip level	-20°C ≤ T <sub>j</sub> ≤ 125°C, V <sub>D</sub> = 15V (only N side)	—	34.5	—	A	
t <sub>off(OC)</sub>	Over current delay time	V <sub>D</sub> = 15V	—	10	—	μs	
OT	Over temperature protection	Base-plate	Trip level	100	110	120	°C
		Temperature detection, V <sub>D</sub> = 15V	Reset level	—	90	—	°C
UV	Supply circuit under voltage protection	-20°C ≤ T <sub>j</sub> ≤ 125°C (only N side)	Trip level	11.5	12.0	12.5	V
			Reset level	—	12.5	—	V
I <sub>FO(H)</sub>	Fault output current (Note 2)	V <sub>D</sub> = 15V, V <sub>FO</sub> = 15V	—	—	0.01	mA	
I <sub>FO(L)</sub>			—	10	15		
t <sub>FO</sub>	Minimum fault output pulse width (Note 2)	V <sub>D</sub> = 15V	1.0	1.8	—	ms	

\* PWN control input frequency is restricted by radiation condition

Note 2 : Fault output is given only when the internal OC, SC, OT & UV protection. (only N side)

Fault output of OC, SC protection given pulse.

Fault output of OT, UV protection given pulse while over level. (OT is only N side)

**PM15CTM060-3**

FLAT-BASE TYPE  
INSULATED PACKAGE

**THERMAL RESISTANCES**

Symbol	Parameter	Test conditions	Limits			Unit
			Min.	Tye.	Max.	
R <sub>th(j-c)Q</sub>	Junction to case thermal resistances	Inverter IGBT part, per 1/6 module	—	—	2.9	°C / W
R <sub>th(j-c)F</sub>		Inverter FWDi part, per 1/6 module	—	—	4.5	°C / W
R <sub>th(c-f)</sub>	Contact thermal resistance	Case to fin, thermal grease applied, per 1/6 module	—	—	0.4	°C / W

**MECHANICAL RATINGS AND CHARACTERISTICS**

Symbol	Parameter	Test conditions	Limits			Unit
			Min.	Tye.	Max.	
—	Mounting torque	Mounting screw : M4	0.98	1.18	1.47	N·m
—	Weight		10	12	15	kg·cm
—	Weight		—	60	—	g

**RECOMMENDED CONDITIONS FOR USE**

Symbol	Parameter	Test conditions	Ratings	Unit
V <sub>CC</sub>	Supply voltage	Applied between : P-N	≤ 400	V
V <sub>D</sub>		Applied between : V <sub>UP1</sub> -V <sub>UPC</sub> , V <sub>VP1</sub> -V <sub>VPC</sub> V <sub>WP1</sub> -V <sub>WPC</sub> , V <sub>UN1</sub> -V <sub>UNC</sub> (Note 3)	15 ± 1.5	V
I <sub>CIN(ON)</sub>	Input on current	Applied between : UP, VP, WP, UN, VN, WN	≥ 5	mA
I <sub>CIN(OFF)</sub>	Input off current		≤ 1	mA
f <sub>PWM</sub>	PWM input frequency	Using application circuit Opto-coupler's input signal	≤ 8	kHz
t <sub>dead</sub>	Arm shoot-through blocking time	Using application circuit Opto-coupler's input signal	≥ 3	μs

Note 3 : Permissible ripple value : dv/dt ≤ ±5V/μs, V<sub>ripple</sub> ≤ 2V<sub>P-P</sub>

# PM15CTM060-3

FLAT-BASE TYPE  
INSULATED PACKAGE

## PERFORMANCE CURVES

OUTPUT CHARACTERISTICS  
(TYPICAL)

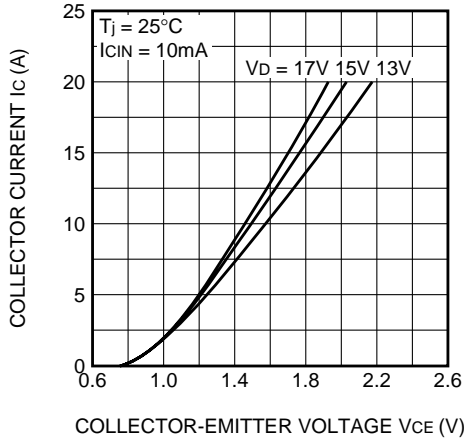

COLLECTOR-EMITTER SATURATION  
VOLTAGE CHARACTERISTICS  
(TYPICAL)

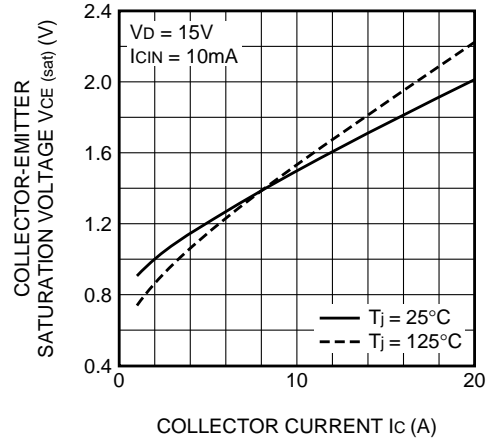

COLLECTOR-EMITTER SATURATION  
VOLTAGE VS. SUPPLY VOLTAGE  
(TYPICAL)

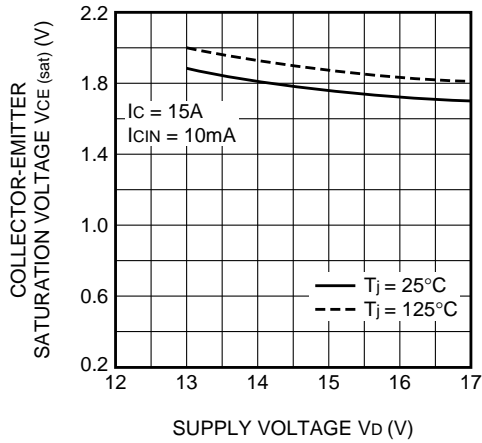

SWITCHING TIME VS.  
COLLECTOR CURRENT  
(TYPICAL)

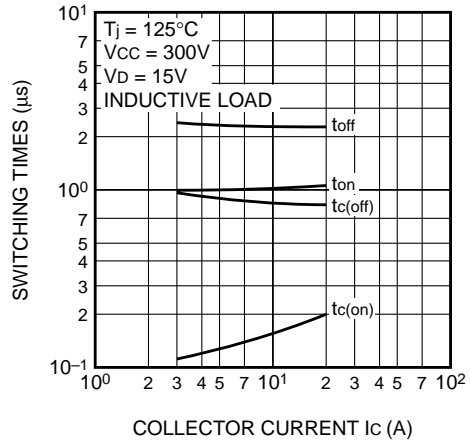

FREE-WHEEL DIODE FORWARD  
CHARACTERISTICS  
(TYPICAL)

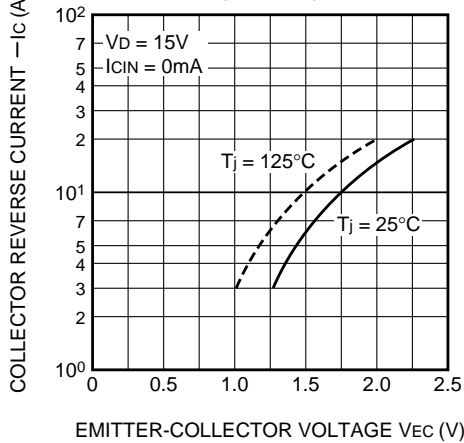

REVERSE RECOVERY CHARACTERISTICS  
OF FREE-WHEEL DIODE  
(TYPICAL)

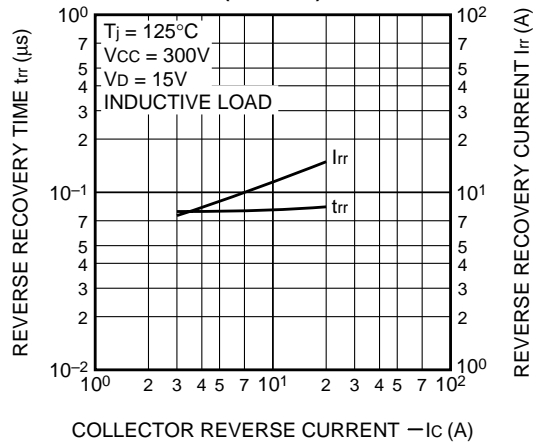

**PM15CTM060-3**

FLAT-BASE TYPE  
INSULATED PACKAGE

