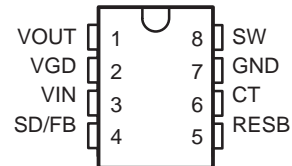


- 1-V Input Voltage Operation Start-Up Ensured Under Full Load on Main Output, and Operation Down to 0.5 V
- 200-mW Output Power at Battery Voltages as Low as 0.8 V
- Secondary 7-V Supply from a Single Inductor
- Output Fully Disconnected in Shutdown
- Adaptive Current Mode Control for Optimum Efficiency
- High Efficiency Over Wide Operating Range
- 6- A Shutdown Supply Current
- Output Reset Function with Programmable Reset Period

PW PACKAGE  
(TOP VIEW)



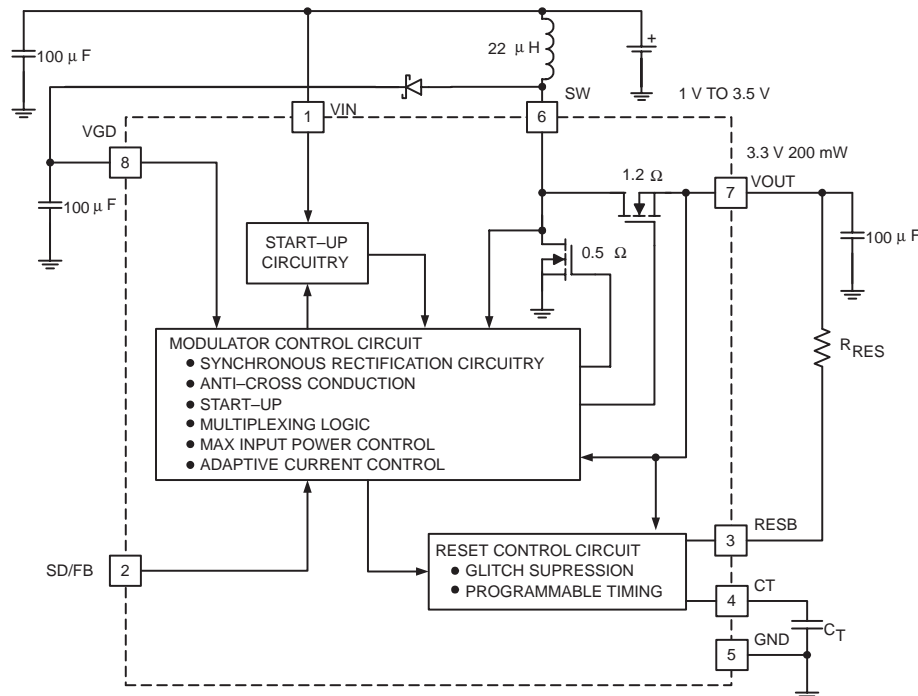
D, N, OR J PACKAGE  
(TOP VIEW)



## description

The UCCx9411 family of low-input voltage, single-inductor-boost converters is optimized to operate from a single or dual alkaline cell, and steps up to a 3.3-V, 5-V, or adjustable output at 200 mW. The UCCx9411 family also provides an auxiliary 7-V output, primarily for the gate-drive supply, which can be used for applications requiring an auxiliary output, such as 5 V, by linear regulating. The primary output starts up under full load at input voltages typically as low as 0.8 V with a ensured max of 1 V, and operates down to 0.5 V once the converter is operating, thereby maximizing battery usage.

## simplified block diagram and application circuit



NOTE A: Pinout shown is for the TSSOP Package. Consult Package Descriptions for the DIP and SOIC configurations.



Please be aware that an important notice concerning availability, standard warranty, and use in critical applications of Texas Instruments semiconductor products and disclaimers thereto appears at the end of this data sheet.

**UCC19411, UCC19412, UCC19413, UCC29411, UCC29412, UCC29413,  
UCC39411, UCC39412, UCC39413  
LOW-POWER SYNCHRONOUS BOOST CONVERTER**

SLUS245B – MARCH 1999 REVISED JULY 2000

**description (continued)**

The UCCx9411 family is designed to accommodate demanding applications such as pagers and cell phones that require high efficiency over a wide operating range of several milli-watts to a couple of hundred milli-watts. High efficiency at low output current is achieved by optimizing switching and conduction losses with a low total quiescent current. At higher output current, the 0.5-Ω switch and 1.2-Ω synchronous rectifier along with continuous mode conduction provide high power efficiency. The wide input voltage range of the UCCx9411 family can accommodate other power sources such as NiCd and NimH.

The UCCx9411 family also provides shutdown control. Packages available are the 8-pin SOIC (D), 8-pin DIP (J or N), and 8-pin TSSOP (PW) to optimize board space.

**absolute maximum ratings over operating free-air temperature (unless otherwise noted)†**

Input Voltage, VIN	−0.3 V to 10 V
Input Voltage, SD	−0.3 V to VIN
Input Voltage, VGD	−0.3 V to 14 V
Input Voltage, SW	−0.3 V to 15 V
Output Voltage, VOUT	−0.3 V to 10 V

† Stresses beyond those listed under “absolute maximum ratings” may cause permanent damage to the device. These are stress ratings only, and functional operation of the device at these or any other conditions beyond those indicated under “recommended operating conditions” is not implied. Exposure to absolute-maximum-rated conditions for extended periods may affect device reliability.

‡ Currents are positive into, negative out of the specific terminal. Consult Packaging Section of the *Portable Products Data Book* (TI Literature Number SLUD001) for thermal limitations and considerations of packages.

**AVAILABLE OPTIONS**

T <sub>J</sub>	Package PW			Package D, N, or J		
	Output Voltage			Output Voltage		
	1.25 V	1.25 V	2.5 V	1.25 V	1.25 V	2.5 V
−55°C to 125°C	19411PW	19412PW	19413PW	19411D/N/J	19412D/N/J	19413D/N/J
−40°C to 85°C	29411PW	29412PW	29413PW	29411D/N/J	29412D/N/J	29413D/N/J
0°C to 70°C	39411PW	39412PW	39413PW	39411D/N/J	39412D/N/J	39413D/N/J



# UCC19411, UCC19412, UCC19413, UCC29411, UCC29412, UCC29413, UCC39411, UCC39412, UCC39413 LOW-POWER SYNCHRONOUS BOOST CONVERTER

SLUS245B – MARCH 1999 REVISED JULY 2000

electrical characteristics,  $T_J = 0^\circ\text{C}$  to  $70^\circ\text{C}$  for the UCC3941x,  $T_J = -40^\circ\text{C}$  to  $85^\circ\text{C}$  for the UCC2941x,  $T_J = -55^\circ\text{C}$  to  $125^\circ\text{C}$  for the UCC1941x,  $V_{IN} = 1.25\text{ V}$  for UCC39411, UCC39412,  $V_{IN} = 2.5\text{ V}$  for the UCC39413,  $T_A = T_J$

PARAMETER	TEST CONDITIONS	UCC3941x			UCC1941x UCC2941x			UNITS	
		MIN	TYP	MAX	MIN	TYP	MAX		
<b>Input Voltage Section</b>									
Minimum start-up voltage	No external VGD load, $I_{OUT} = 60\text{ mA}$	$T_J = 25^\circ\text{C}$ , See Note 1		0.8	1	0.08	1	V	
	No external VGD load, See Note 1	$I_{OUT} = 60\text{ mA}$		0.9	1.1	1.2	1.4	V	
Minimum dropout voltage	No external VGD load, $I_{OUT} = 10\text{ mA}$ See Note 1	0.5			0.7			V	
Input voltage range		1.1	3.2		1.3	3.2		V	
Quiescent supply current	See Note 2	6		12		8	16		$\mu\text{A}$
Supply current at shutdown	SD = GND	6		12		8	16		$\mu\text{A}$
<b>Output Section</b>									
Quiescent supply current	See Note 2	15		28		20	37		$\mu\text{A}$
Supply current at shutdown	SD = GND	3		6		5	10		$\mu\text{A}$
Regulation voltage (UCC39412)	$1\text{ V} < V_{IN} < 3\text{ V}$	3.2		3.3	3.39	3.15	3.3	3.45	V
	$1\text{ V} < V_{IN} < 3\text{ V}$ , See Note 1	0 mA < $I_{OUT} < 60\text{ mA}$		3.17	3.3	3.43	3.11	3.3	3.5
Regulation voltage (UCC39413)	$1\text{ V} < V_{IN} < 5\text{ V}$	4.85		5	5.15	4.78	5	5.23	V
	$1\text{ V} < V_{IN} < 5\text{ V}$ , See Note 1	0 mA < $I_{OUT} < 60\text{ mA}$		4.8	5	5.2	4.71	5	5.3
ADJ voltage (UCC39411)	$1\text{ V} < V_{IN} < 3\text{ V}$	1.212	1.25	1.288	1.194	1.25	1.306	V	
Maximum output voltage (UCCx9411)		5.5			5.5			V	
<b>VGD Output Section</b>									
Quiescent supply current	See Note 2	20		40		27	55		$\mu\text{A}$
Supply current at shutdown	SD = GND	20		40		27	55		$\mu\text{A}$
Regulation voltage (UCC39411/2)	$1\text{ V} < V_{IN} < 3\text{ V}$	6.3		7	7.7	6.3	7	7.7	V
	$1\text{ V} < V_{IN} < 3\text{ V}$ , See Note 1	0 mA < $I_{OUT} < 10\text{ mA}$		6.3	7	7.7	6.3	7	7.7
Regulation voltage (UCC39413)	$1\text{ V} < V_{IN} < 5\text{ V}$	7.7		8.5	9.3	7.7	8.5	9.3	V
	$1\text{ V} < V_{IN} < 5\text{ V}$ , See Note 1	0 mA < $I_{OUT} < 10\text{ mA}$		7.7	8.5	9.3	7.7	8.5	9.3
<b>Inductor Charging Section (L = 22 <math>\mu\text{H}</math>)</b>									
Peak discontinuous current	Operating range, L = 22.1 $\mu\text{H}$	180	250	300	180	250	300	mA	
Peak continuous current		385	550	715	385	550	715	mA	
Charge switch $R_{DS(on)}$	D package	0.5		0.75		0.6	0.85		$\Omega$
Current limit delay	See Note 1	50			50			ns	
<b>Synchronous Rectifier Section</b>									
Rectifier $R_{DS(on)}$	D package	1.2		1.8		1.4	2.16		$\Omega$

NOTES: 1. Ensured by design. Not production tested.

2. For the UCC39411  $V_B = 1.306\text{ V}$ ,  $V_{GD} = 7.7\text{ V}$ , For the UCC39412  $V_{OUT} = 3.5\text{ V}$  and  $V_{GD} = 7.7\text{ V}$ , For the UCC39413  $V_{OUT} = 5.3\text{ V}$ ,  $V_{GD} = 9.3\text{ V}$ .



**UCC19411, UCC19412, UCC19413, UCC29411, UCC29412, UCC29413,  
UCC39411, UCC39412, UCC39413  
LOW-POWER SYNCHRONOUS BOOST CONVERTER**

SLUS245B – MARCH 1999 REVISED JULY 2000

electrical characteristics,  $T_J = 0^\circ\text{C}$  to  $70^\circ\text{C}$  for the UCC3941x,  $T_J = -40^\circ\text{C}$  to  $85^\circ\text{C}$  for the UCC2941x,  $T_J = -55^\circ\text{C}$  to  $125^\circ\text{C}$  for the UCC1941x,  $V_{IN} = 1.25\text{ V}$  for UCC39411, UCC39412,  $V_{IN} = 2.5\text{ V}$  for the UCC39413,  $T_A = T_J$  (continued)

PARAMETER	TEST CONDITIONS	UCC3941x			UCC1941x UCC2941x			UNITS
		MIN	TYP	MAX	MIN	TYP	MAX	UNITS
<b>Shutdown Section</b>								
Threshold		0.4	0.6	0.8	0.2	0.6	0.9	V
Input bias current	SD = GND	2	5	15	2	5	15	$\mu\text{A}$
	SD = 1.25 V		5	20		20	100	nA
<b>Reset Section</b>								
Threshold (UCC39411)		1.08	1.125	1.17	1.07	1.125	1.18	V
Threshold (UCC39412)		2.85	2.97	3.09	2.83	2.97	3.11	V
Threshold (UCC39413)		4.32	4.5	4.68	4.3	4.5	4.7	V
Reset period	$C_T = 0.15\ \mu\text{F}$	113	188	263	94	188	282	ms
$V_{OUT}$ to reset delay	$V_{OUT}$ falling at $-1\text{ mV}/\mu\text{s}$ , See Note 1		60			60		$\mu\text{s}$
Sink current		1	20		1	20		mA
Output low voltage	$I_{OUT} = 500\ \mu\text{A}$			0.1			0.1	V
Output leakage				0.5			0.5	$\mu\text{A}$

NOTES: 1. Ensured by design. Not production tested.  
2. For the UCC39411  $FB = 1.306\text{ V}$ ,  $V_{GD} = 7.7\text{ V}$ , For the UCC39412  $V_{OUT} = 3.5\text{ V}$  and  $V_{GD} = 7.7\text{ V}$ , For the UCC39413  $V_{OUT} = 5.3\text{ V}$ ,  $V_{GD} = 9.3\text{ V}$ .

**pin assignments**

**VIN:** Input voltage to supply the IC during start-up. After the output is running the IC draws power from  $V_{OUT}$  or  $V_{GD}$ .

**SW:** An inductor is connected between this pin and  $V_{IN}$ . The  $V_{GD}$  (gate drive supply) flyback diode is also connected to this pin. When servicing the main output supply this pin pulls low, charging the inductor, then shuts off dumping the energy through the synchronous rectifier to the output. When servicing the  $V_{GD}$  supply, the internal synchronous rectifier stays off and the energy is diverted to  $V_{GD}$  through the flyback diode. During discontinuous portions of the inductor current, a MOSFET resistively connects  $V_{IN}$  to  $SW$  damping excess circulating energy to eliminate undesired high-frequency ringing.

**VGD:** The  $V_{GD}$  pin, which is coarsely regulated around  $7\text{ V}$  ( $8.5\text{ V}$  for the UCC39413), is primarily used for the gate drive supply for the power switches in the IC. This pin can be loaded with up to  $10\text{ mA}$  as long as it does not present a load at voltages below  $2\text{ V}$  (this ensures proper start-up of the IC). The  $V_{GD}$  supply can go as low as  $6.3\text{ V}$  without interfering with the servicing of the main output. When below  $6.3\text{ V}$ ,  $V_{GD}$  has the highest priority.

**VOUT:** Main output voltage ( $3.3\text{ V}$ ,  $5\text{ V}$ , or adjustable), has highest priority in the multiplexing scheme, as long as  $V_{GD}$  is above the critical level of  $6.3\text{ V}$ . Startup at full load is achievable at input voltages down to  $1\text{ V}$ .

**CT:** This pin provides the timer for determining the reset period. The period is controlled by placing a capacitor to ground of value  $C = (0.81e^{-6}) \times t$  where  $t$  is the desired reset period.

**RESB:** This pin provides an active low signal to alert the user when the main output voltage falls below 10% of its targeted value. The open-drain output can be used to reset a microcontroller that may be powered off of the main output voltage.

**SD/FB:** For the UCC39411, this pin is used to adjust the output voltage via a resistive divider from  $V_{OUT}$ . It also serves as the shutdown pin for all three versions. Pulling this pin low provides a shutdown signal to the IC.

**GND:** Ground of the IC.



---

## APPLICATION INFORMATION

### operation

A detailed block diagram of the UCC39411 is shown in Figure 1. Unique control circuitry provides high-efficiency power conversion for both light and heavy loads by transitioning between discontinuous and continuous conduction based on load conditions. Figure 2 depicts converter waveforms for the application circuit shown in Figure 3. A single 22- $\mu$ H inductor provides the energy pulses required for a highly efficient 3.3-V converter at up to 200-mW output power.

At time t1, the 3.3-V output voltage has dropped below its lower threshold, and the inductor is charged with an on time determined by:  $t_{ON} = 5.5 \mu\text{s}/V_{IN}$ . For a 1.25-V input and a 22- $\mu$ H inductor, the resulting peak current is approximately 250 mA. At time t2, the inductor begins to discharge with a minimum off time of approximately 1 ms. Under lightly loaded conditions, the amount of energy delivered in this single pulse satisfies the voltage-control loop, and the converter does not command any more energy pulses until the output again drops below the lower-voltage threshold.

At time t3, the VGD supply drops below its lower threshold, but the output voltage is still above its threshold point. This results in an energy pulse to the gate-drive supply at t4. In some cases, a single pulse supplied to VGD is insufficient to raise the VGD voltage level enough to satisfy the voltage loop. Under this condition, multiple pulses are supplied to VGD. Note that when the UCC3941x is servicing VGD only, the IC maintains a discontinuous mode of operation. After time t4, the 3.3-V output drops below its threshold and requests to be serviced once the VGD cycle has completed, which occurs at time t5.

Time t6 represents a transition between light load and heavy load. A single energy pulse is not sufficient to force the output voltage above its upper threshold before the minimum off time has expired and a second charge cycle is commanded. Since the inductor current does not reach zero in this case, the peak current is greater than 250 mA at the end of the next charge on time. The result is a ratcheting of inductor current until either the output voltage is satisfied, or the converter reaches its set current limit. At time t7, the gate drive voltage has dropped below its 7-V threshold but the converter continues to service the output because it has higher priority unless VGD drops below  $\approx 6.3$  V.

Between time t7 and t8, the converter reaches its peak current limit.

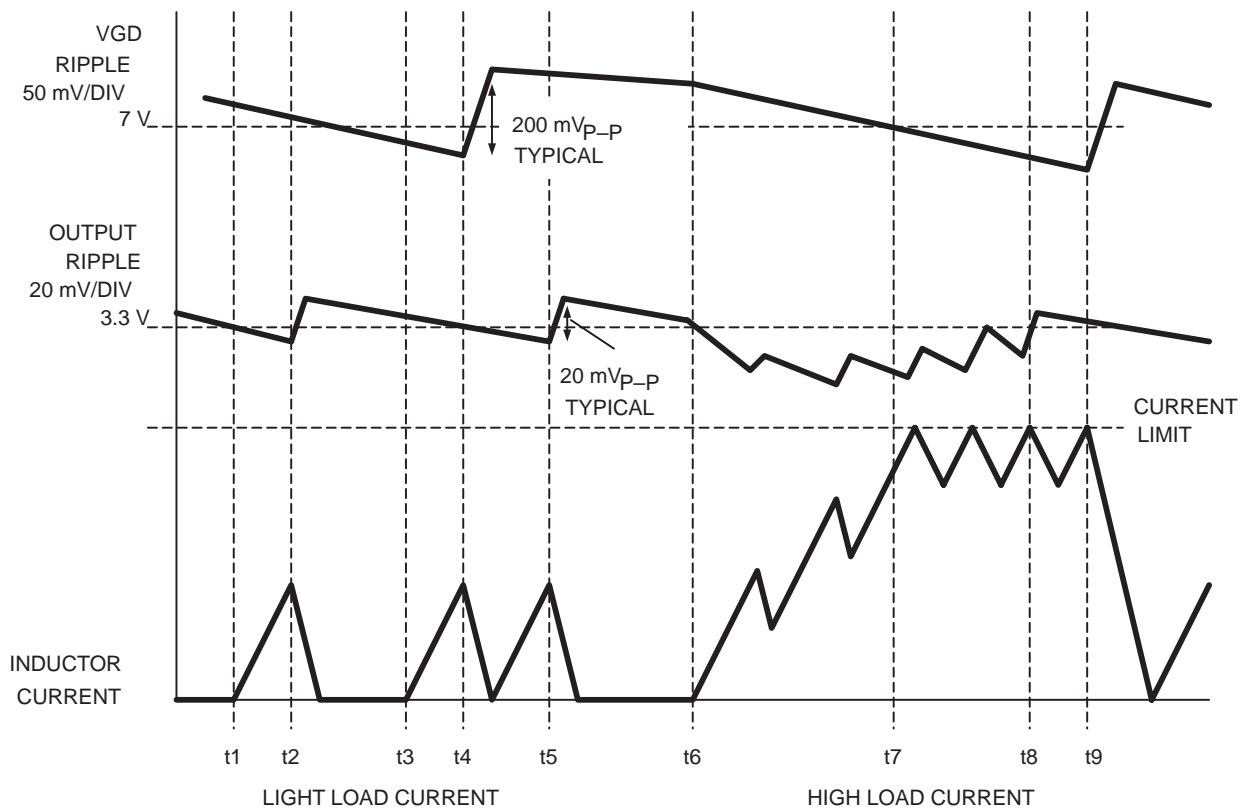
Once the peak current is reached, the converter operates in continuous mode with approximately 60-mA of inductor current ripple. At time t8, the 3.3-V output is satisfied and the converter can service the gate drive voltage, VGD, which occurs at time t9.



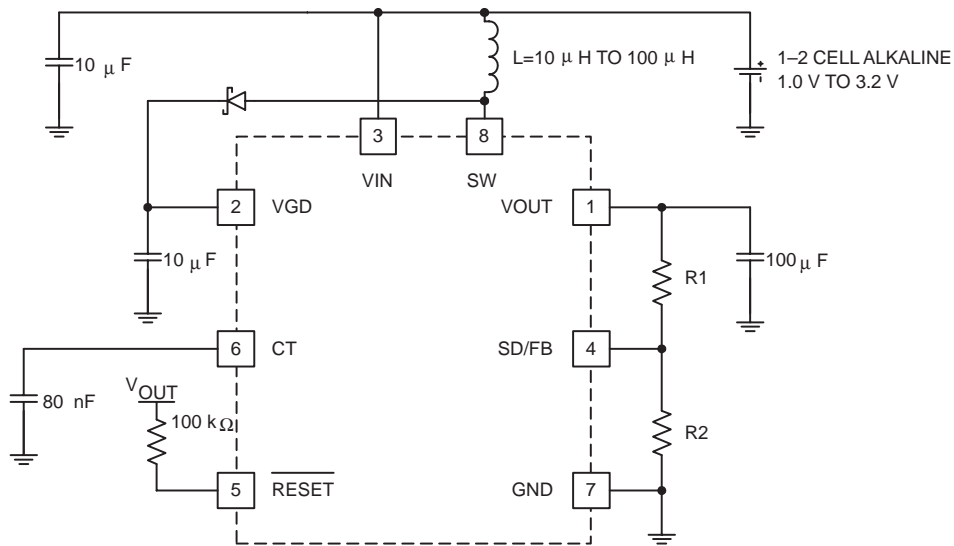
**UCC19411, UCC19412, UCC19413, UCC29411, UCC29412, UCC29413,  
UCC39411, UCC39412, UCC39413**

SLUS245B – MARCH 1999 REVISED JULY 2000

**APPLICATION INFORMATION**



**Figure 2. Inductor Current and Output Ripple Waveforms**



**Figure 3. Low Power Synchronous Boost Converter ADJ Version –200 mW**

NOTE A: Pinout shown is for the TSSOP Package. Consult Package Descriptions for the DIP and SOIC configurations.

# UCC19411, UCC19412, UCC19413, UCC29411, UCC29412, UCC29413, UCC39411, UCC39412, UCC39413 LOW-POWER SYNCHRONOUS BOOST CONVERTER

SLUS245B – MARCH 1999 REVISED JULY 2000

## APPLICATION INFORMATION

### shutdown control

Shutdown of the UCC3941x is controlled via the interface with the SD/FB pin. Pulling the SD/FB pin low, for all versions, causes the IC to go into shutdown. In the UCC39412 and UCC39413, the SD/FB pin is used solely as a shutdown function. Therefore, the SD/FB pin for the UCC39412 and UCC39413 can be directly controlled using conventional CMOS or transistor to transistor logic (TTL) technology. For the UCC39411, interface into the SD/FB is slightly more complicated due to the added feedback function. When feeding back the output voltage to the SD/FB pin on the UCC39411, the IC requires a Thevenin impedance of at least 200-k $\Omega$  (500-k $\Omega$  for industrial/military applications) to ground. Then, to accomplish shutdown of the IC, an open-drain device may be used.

### component selection inductor selection

An inductor value of 22  $\mu$ H works well in most applications, but values between 10  $\mu$ H to 100  $\mu$ H are also acceptable. Lower value inductors typically offer lower ESR and smaller physical size. Due to the nature of the “bang-bang” controllers, larger inductor values typically result in larger overall voltage ripple, because once the output voltage level is satisfied the converter goes discontinuous, resulting in the residual energy of the inductor causing overshoot.

It is recommended to keep the ESR of the inductor below 0.15  $\Omega$  for 200-mW applications. A Coilcraft DT3316P-223 surface-mount inductor is acceptable because it has a current rating of 1.5 A and an ESR of 84 m $\Omega$ .

Other choices for surface-mount inductors are shown in Table 1.

Table 1. Inductor Suppliers

MANUFACTURER	PART NUMBERS
<b>Coilcraft</b> Cary, Illinois Tel: 708-639-2361 Fax: 708-639-1469	DT Series
<b>Coiltronics</b> Boca Raton, Florida Tel: 407-241-7876	CTX Series

### output capacitor selection

Once the inductor value is selected, the capacitor value determines the ripple of the converter. The worst case peak-to-peak ripple of a cycle is determined by two components, one is due to the charge storage characteristic, and the other is the ESR of the capacitor. The worst case ripple occurs when the inductor is operating at max current and is expressed as follows:

$$\Delta V = \frac{(I_{CL})^2 L}{2C(V_O - V_I)} + I_{CL} C_{ESR}$$



## APPLICATION INFORMATION

### output capacitor selection (continued)

- $I_{CL}$  = the peak inductor current = 550 mA
- $\Delta V$  = Output ripple
- $V_O$  = Output voltage
- $V_I$  = Input voltage
- $C_{ESR}$  = ESR of the output capacitor

A Sanyo OS-CON series surface-mount capacitor (10SN100M) is acceptable. It has an ESR rating of 90 m $\Omega$  at 100  $\mu$ F.

Other potential capacitor sources are shown in Table 2.

**Table 2. Capacitor Supplies**

MANUFACTURER	PART NUMBER
<b>Sanyo Video Components</b> San Diego, California Tel: 619-661-6322 Fax: 619-661-1055	OS-CON Series
<b>AVX</b> Sanford, Maine Tel: 207-282-5111 Fax: 207-283-1941	TPS Series
<b>Sprague</b> Concord, New Hampshire Tel: 603-224-1961	695D Series

### input capacitor selection

Since the UCCx9411 family does not require a large decoupling capacitor on the input voltage to operate properly, a 10- $\mu$ F cap is sufficient for most applications. Optimum efficiency occurs when the capacitor value is large enough to decouple the source impedance, this usually occurs for capacitor values in excess of 100  $\mu$ F.

### RESET operation

A reset function is provided to prevent the microprocessor from executing code during undervoltage conditions, typically during power up or power down. The reset voltage threshold is fixed at 90% of the output voltage for all versions of the UCCx941x. To prevent erratic operation in noisy environments, a glitch filter is provided.

To allow sufficient time for the microprocessor clock to stabilize, a user-programmable reset period is provided. The reset period, the time from the output voltage rising above 90% of nominal to RESB going high, is programmed via an external capacitor connected to the CT pin.

The reset period is defined as:

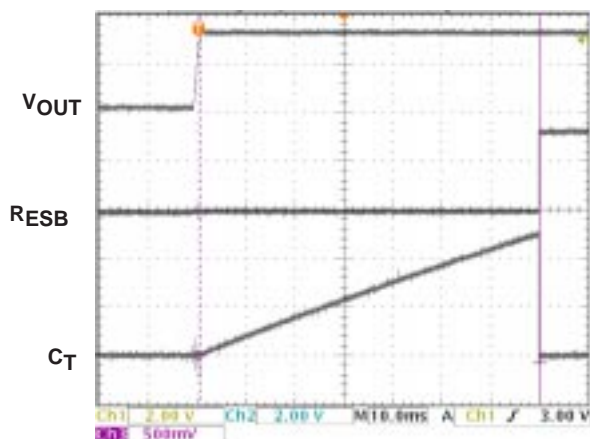
$$t_{RP} = C \times 1.25$$

where C is in  $\mu$ F, and  $t_{RP}$  is in seconds.

A typical reset profile during power up is shown in Figure 4 and power down in Figure 5.

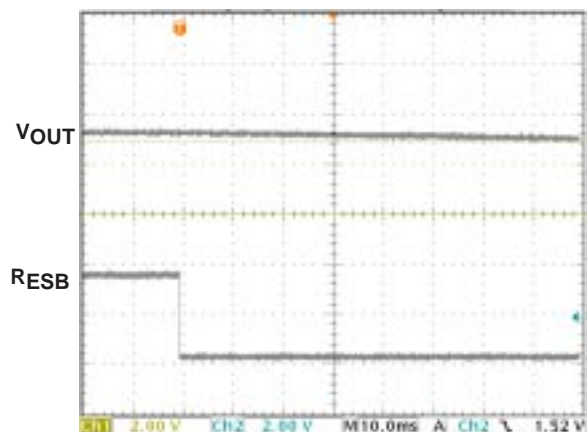
**APPLICATION INFORMATION**

**POWER-UP SEQUENCE**



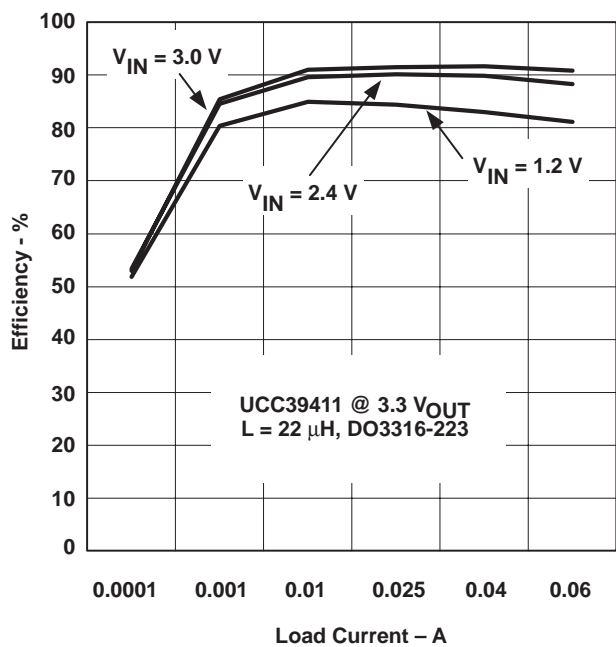
**Figure 4**

**POWER-DOWN SEQUENCE**



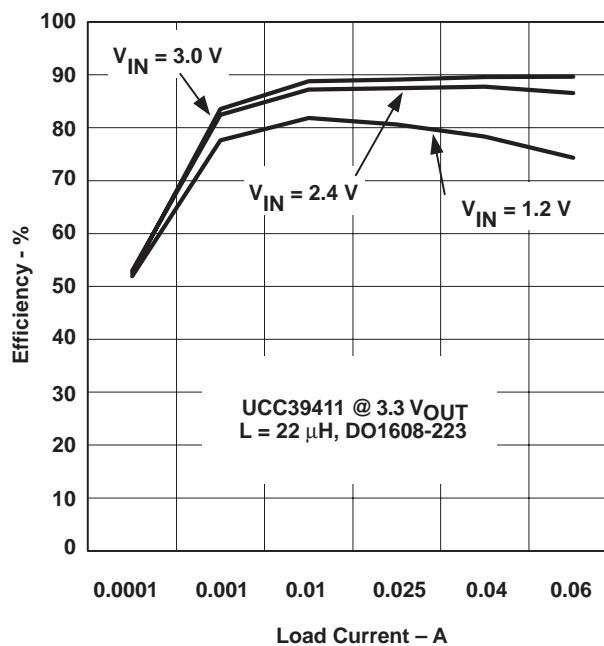
**Figure 5**

**TYPICAL EFFICIENCY  
 VS  
 LOAD CURRENT**



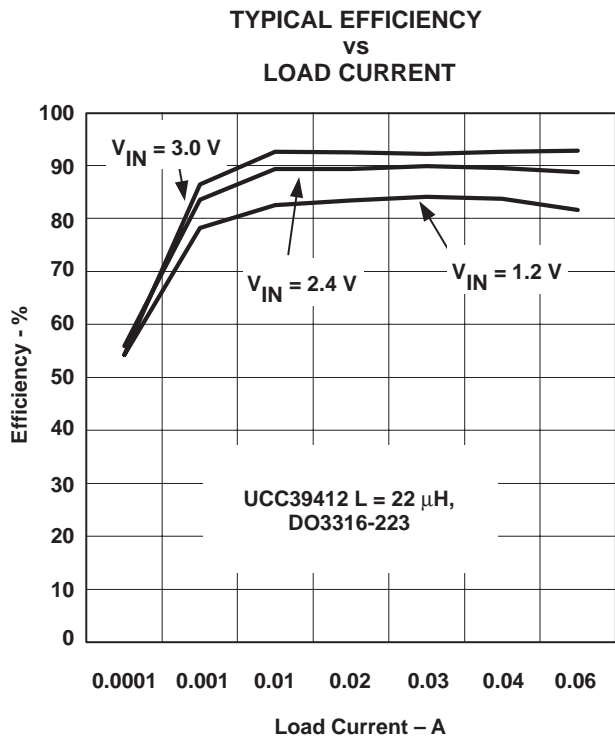
**Figure 6**

**TYPICAL EFFICIENCY  
 VS  
 LOAD CURRENT**

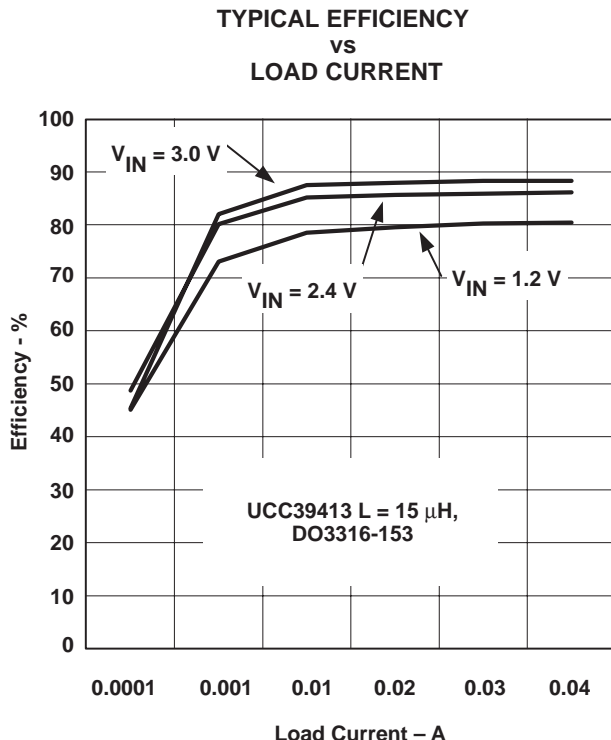


**Figure 7**

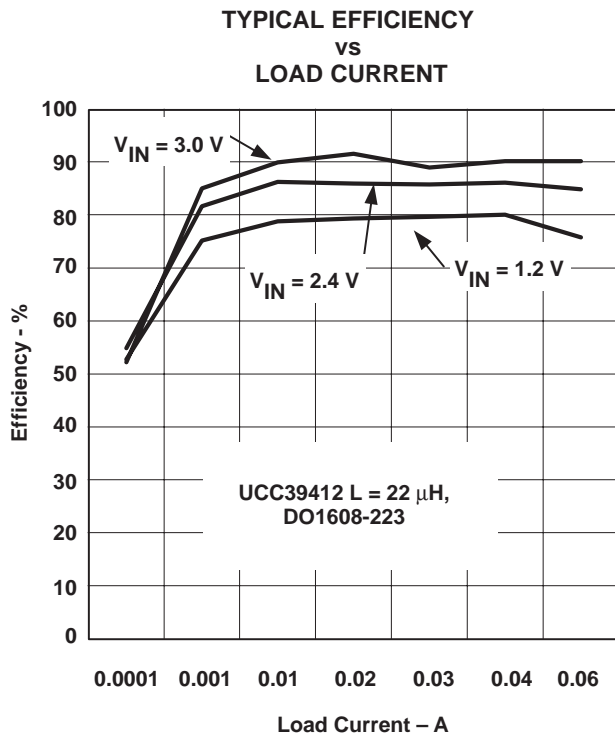
**APPLICATION INFORMATION**



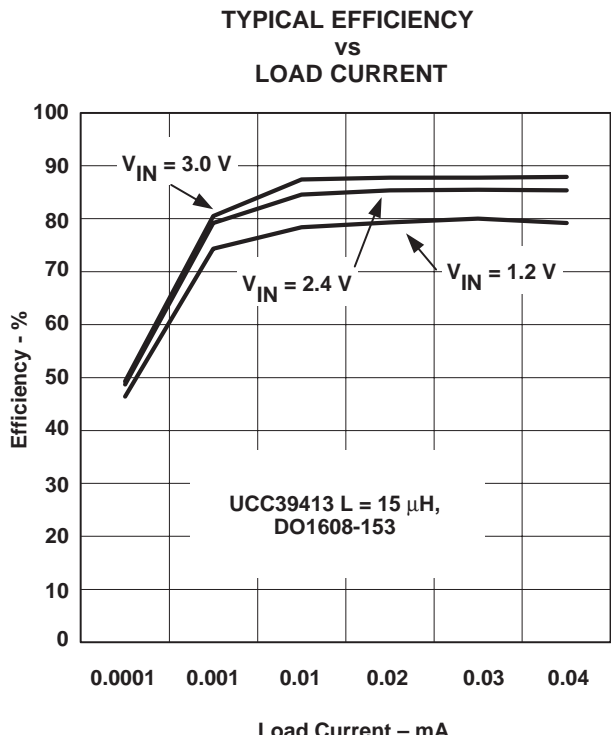
**Figure 8**



**Figure 9**



**Figure 10**



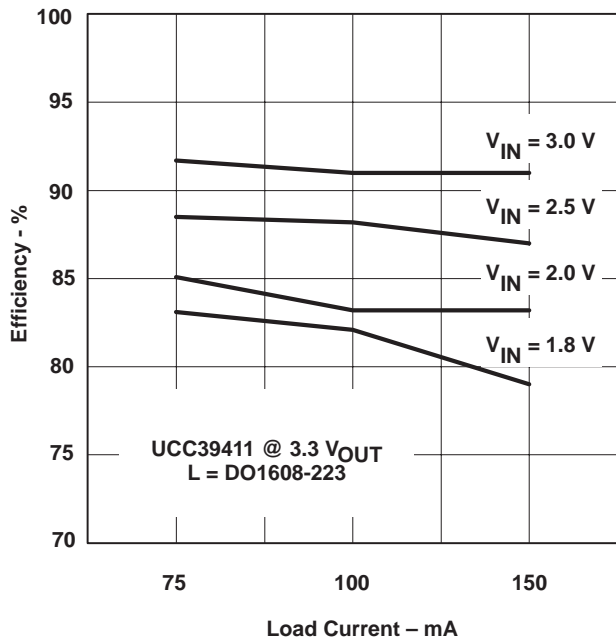
**Figure 11**

**UCC19411, UCC19412, UCC19413, UCC29411, UCC29412, UCC29413,  
 UCC39411, UCC39412, UCC39413  
 LOW-POWER SYNCHRONOUS BOOST CONVERTER**

SLUS245B – MARCH 1999 REVISED JULY 2000

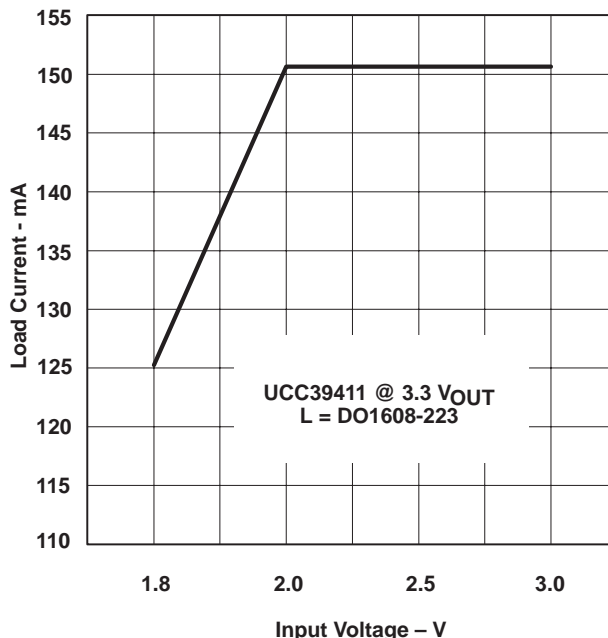
**APPLICATION INFORMATION**

**TYPICAL EFFICIENCY  
 vs  
 LOAD CURRENT (TWO CELL  
 APPLICATION)**



**Figure 12**

**MAXIMUM LOAD CURRENT,  
 2 CELL APPLICATION  
 vs  
 INPUT CURRENT**



**Figure 13**

## **IMPORTANT NOTICE**

Texas Instruments and its subsidiaries (TI) reserve the right to make changes to their products or to discontinue any product or service without notice, and advise customers to obtain the latest version of relevant information to verify, before placing orders, that information being relied on is current and complete. All products are sold subject to the terms and conditions of sale supplied at the time of order acknowledgment, including those pertaining to warranty, patent infringement, and limitation of liability.

TI warrants performance of its semiconductor products to the specifications applicable at the time of sale in accordance with TI's standard warranty. Testing and other quality control techniques are utilized to the extent TI deems necessary to support this warranty. Specific testing of all parameters of each device is not necessarily performed, except those mandated by government requirements.

Customers are responsible for their applications using TI components.

In order to minimize risks associated with the customer's applications, adequate design and operating safeguards must be provided by the customer to minimize inherent or procedural hazards.

TI assumes no liability for applications assistance or customer product design. TI does not warrant or represent that any license, either express or implied, is granted under any patent right, copyright, mask work right, or other intellectual property right of TI covering or relating to any combination, machine, or process in which such semiconductor products or services might be or are used. TI's publication of information regarding any third party's products or services does not constitute TI's approval, warranty or endorsement thereof.