

Typical Applications

- TDMA/GSM/EDGE Handsets
- GSM/EDGE Handsets
- W-CDMA Handsets
- TDMA-Based Wireless Applications
- Wireless Local Loop
- Basestations

Product Description

The RF2483 is a dual-band direct I/Q to RF modulator designed for handset applications where multiple modes of operation are required. The device provides common differential I/Q inputs and a common AGC amplifier. Independent single-ended LO inputs and single-ended high and low band RF outputs are provided. The device achieves a very low out-of-band noise density of -156dBm/Hz minimizing RF filtering. Operating from a single 2.7V supply, the device is packaged in a 4mmx4mm, 20-pin, plastic leadless chip carrier.

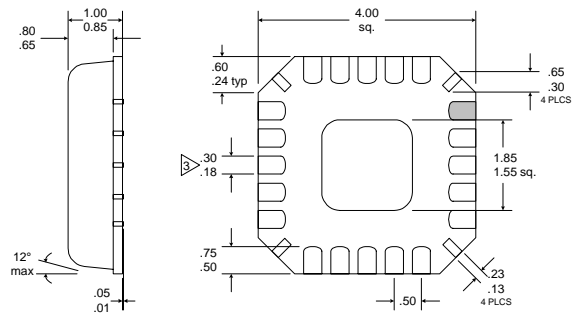

- NOTES:
- 1 Shaded Pin is Lead 1.
  - 2 Pin 1 identifier must exist on top surface of package by identification mark or feature on the package body. Exact shape and size is optional.
  - 3 Dimension applies to plated terminal: to be measured between 0.02 mm and 0.25 mm from terminal end.
  - 4 Package Warpage: 0.05 mm max.
  - 5 Die Thickness Allowable: 0.305 mm max.

**5**  
MODULATORS AND  
UPCONVERTERS

Optimum Technology Matching® Applied

- |                                     |  |                                      |
|-------------------------------------|--|--------------------------------------|
| <input type="checkbox"/> Si BJT     | <input type="checkbox"/> GaAs HBT            | <input type="checkbox"/> GaAs MESFET |
| <input type="checkbox"/> Si Bi-CMOS | <input checked="" type="checkbox"/> SiGe HBT | <input type="checkbox"/> Si CMOS     |

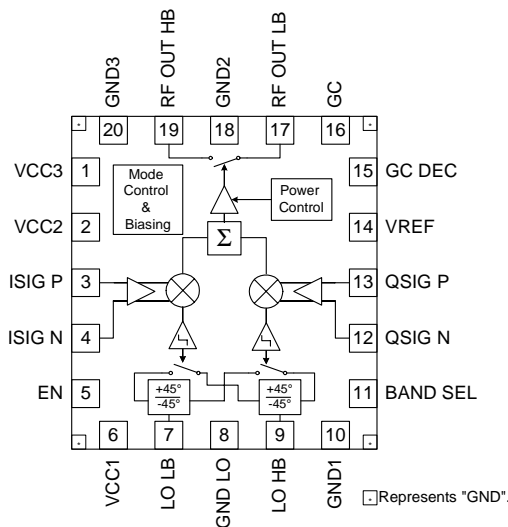

Functional Block Diagram

Package Style: LCC, 20-Pin, 4 x 4

Features

- Dual-Band Operation 700-2200MHz
- -156dBm/Hz noise @ 20MHz offset
- +19dBm OIP3
- +6dBm OP1dB
- 35dB Gain Control Range
- Single 2.7V to 3.3V Supply

Ordering Information

- |             |   |
|-------------|---|
| RF2483      | Low Noise Dual-Band Quadrature Modulator with AGC |
| RF2483 PCBA | Fully Assembled Evaluation Board                  |

RF Micro Devices, Inc.  
7628 Thorndike Road  
Greensboro, NC 27409, USA

Tel (336) 664 1233  
Fax (336) 664 0454  
<http://www.rfmd.com>

### Absolute Maximum Ratings

Parameter	Rating	Unit
Supply Voltage	-0.5 to 3.6	V
Storage Temperature	-40 to +150	°C
Operating Ambient Temperature	-40 to +85	°C
Input Voltage, any pin	-0.5 to 3.6	V
Input Power, any pin	+10	dBm



**Caution!** ESD sensitive device.

RF Micro Devices believes the furnished information is correct and accurate at the time of this printing. However, RF Micro Devices reserves the right to make changes to its products without notice. RF Micro Devices does not assume responsibility for the use of the described product(s).

Parameter	Specification			Unit	Condition
	Min.	Typ.	Max.		
<b>Operating Range</b>					
Supply Voltage*	2.7		3.3	V	
Temperature Range*	-40		+85	°C	
High Band Frequency Range*	1700		2200	MHz	Bandset=2.7V
Low Band Frequency Range*	700		1000	MHz	Bandset=0V
<b>DC Parameters</b>					
High Band Supply Current	65	85	110	mA	GC=2.0V, V <sub>CC</sub> =2.7V, EN=2.7V, Bandset=2.7V, IQ=1.2V <sub>DC</sub> , T <sub>A</sub> =25°C
Low Band Supply Current	65	85	110	mA	GC=2.0V, V <sub>CC</sub> =2.7V, EN=2.7V, Bandset=0V, IQ=1.2V <sub>DC</sub> , T <sub>A</sub> =25°C
Sleep Current		<1.0	10	µA	EN=0V
Logic Levels					
Input Logic Low	0		0.5	V	
Input Logic High	1.4		V <sub>CC</sub>	V	
Logic Pins Input Current*		<1.0		µA	
<b>LO Input Port</b>					
High Band Frequency Range*	1700		2200	MHz	Bandset=2.7V
Low Band Frequency Range*	700		1000	MHz	Bandset=0V
High Band LO Input Power*	-3	0	6	dBm	Bandset=2.7V
LO Band LO Input Power*	-3	0	6	dBm	Bandset=0V
Input Impedance*		50		Ω	

Parameter	Specification			Unit	Condition
	Min.	Typ.	Max.		
<b>I/Q Modulator High Band</b>					$V_{CC}=2.7V$ , $EN=2.7V$ , $Bandset=2.7V$ , $FLO=0dBm$ , $PLO=1900MHz$ , LO HB and RF OUT HB ports are matched to $50\Omega$ . $IQ=800mV_{P-P}$ at $100kHz$ $1.2V_{DC}$ . Input IQ signals driven differentially and in quadrature from a $50\Omega$ source impedance. $T_A=25^\circ C$
Baseband Input Voltage*	1.15	1.2	1.25	V	Common mode voltage
Baseband Input Level		0.8		$V_{PP}$	Measured differentially
Baseband Input Impedance*		5.5		$k\Omega$	Measured at $100kHz$
Input Bandwidth*	50	150		MHz	I/Q source impedance $50\Omega$
Sideband Suppression	30	43		dBc	GC=2.0V, no I/Q adjustment
	30	43		dBc	GC=1.5V, no I/Q adjustment
	30	46		dBc	GC=1.0V, no I/Q adjustment
	30	47		dBc	GC=0.5V, no I/Q adjustment
Carrier Suppression	30	48		dBc	GC=2.0V, no I/Q adjustment
	30	44		dBc	GC=1.5V, no I/Q adjustment
	25	40		dBc	GC=1.0V, no I/Q adjustment
	25	35		dBc	GC=0.5V, no I/Q adjustment
3rd Harmonic of Modulation Suppression at FLO-3x100kHz	40	47		dBc	GC=2.0V
	40	47		dBc	GC=1.5V
	35	42		dBc	GC=1.0V
	35	42		dBc	GC=0.5V
Baseband Inputs DC Current Drain*			100	$\mu A$	
Baseband Inputs AC Current Drain*			100	$\mu A_{PP}$	
<b>I/Q Modulator Low Band</b>					$V_{CC}=2.7V$ , $EN=2.7V$ , $Bandset=0V$ , $FLO=0dBm$ , $PLO=900MHz$ , LO LB and RF OUT LB ports are matched to $50\Omega$ . $IQ=800mV_{P-P}$ at $100kHz$ $1.2V_{DC}$ . Input IQ signals driven differentially and in quadrature from a $50\Omega$ source impedance. $T_A=25^\circ C$
Baseband Input Voltage*	1.15	1.2	1.25	V	Common mode voltage
Baseband Input Level		0.8		$V_{PP}$	Measured differentially
Baseband Input Impedance*		5.5		$k\Omega$	Measured at $100kHz$
Input Bandwidth*	50	150		MHz	I/Q source impedance $50\Omega$
Sideband Suppression	30	37		dBc	GC=2.0V, no I/Q adjustment
	30	37		dBc	GC=1.5V, no I/Q adjustment
	30	44		dBc	GC=1.0V, no I/Q adjustment
	30	40		dBc	GC=0.5V, no I/Q adjustment
Carrier Suppression	30	52		dBc	GC=2.0V, no I/Q adjustment
	30	50		dBc	GC=1.5V, no I/Q adjustment
	25	33		dBc	GC=1.0V, no I/Q adjustment
	15	22		dBc	GC=0.5V, no I/Q adjustment
3rd Harmonic of Modulation Suppression at FLO-3x100kHz	40	59		dBc	GC=2.0V
	40	59		dBc	GC=1.5V
	35	48		dBc	GC=1.0V
	35	41		dBc	GC=0.5V
Baseband Inputs DC Current Drain*			100	$\mu A$	
Baseband Inputs AC Current Drain*			100	$\mu A_{PP}$	

Parameter	Specification			Unit	Condition
	Min.	Typ.	Max.		
<b>Variable Gain Amplifiers High Band</b>					$V_{CC}=2.7V$ , $EN=2.7V$ , $BandSel=2.7V$ , $FLO=0dBm$ , $PLO=1900MHz$ , LO HB and RF OUT HB ports are matched to $50\Omega$ . Input IQ signals driven differentially and in quadrature from a $50\Omega$ source impedance. $T_A=25^\circ C$
Gain Control Voltage Range	0		2.0	V	
Gain Control Range	32	35		dB	Difference between output power at $GC=2.0V$ and $GC=0.5V$
Gain Control Slope	23		29	dB/V	Calculated $GC=1.0V$ and $1.5V$
Gain Control Input Impedance*		10		k $\Omega$	
Output Power	-3	0.4	3	dB	$GC=2.0V$ , $IQ=800mV_{p,p}$ at 100kHz
	-11	-7	-5	dB	$GC=1.5V$ , $IQ=800mV_{p,p}$ at 100kHz
	-23	-20	-17	dB	$GC=1.0V$ , $IQ=800mV_{p,p}$ at 100kHz
	-36	-35	-30	dB	$GC=0.5V$ , $IQ=800mV_{p,p}$ at 100kHz
Output Noise at $FLO+20MHz^*$		-155		dBm/Hz	$GC=2.0V$ , $IQ=800mV_{p,p}$ at 100kHz
		-156.7		dBm/Hz	$GC=2.0V$ , $IQ=0mV_{p,p}$
Output P1dB*		+6		dBm	IQ at 100kHz
Output IP3*		+20		dBm	$GC=2.0V$ . Extrapolated from IM3 with two baseband tones at 90kHz applied differentially, in quadrature, at both I and Q inputs, each tone $400mV_{p,p}$
Intermodulation IM3 tone at $FLO+70kHz$ and $FLO+130kHz$ relative to tone at $FLO+90kHz$					Two baseband tones at 90kHz and 110kHz applied differentially, in quadrature, at both I and Q inputs, each tone $400mV_{p,p}$
	40	50		dBc	$GC=2.0V$
	40	50		dBc	$GC=1.5V$
	30	35		dBc	$GC=1.0V$
	30	35		dBc	$GC=0.5V$

Parameter	Specification			Unit	Condition
	Min.	Typ.	Max.		
<b>Variable Gain Amplifiers Low Band</b>					$V_{CC}=2.7V$ , $EN=2.7V$ , $BandSel=0V$ , $FLO=0dBm$ , $PLO=900MHz$ , LO LB and RF OUT LB ports are matched to $50\Omega$ . Input IQ 1.2Vdc, signals driven differentially and in quadrature from a $50\Omega$ source impedance. $T_A=25^\circ C$
Gain Control Voltage Range	0		2.0	V	
Gain Control Range	32	36		dB	Difference between output power at $GC=2.0V$ and $0.5V$
Gain Control Slope	27		33	dB/V	Calculated using output power at $GC=1.0V$ and $1.5V$
Gain Control Input Impedance*		10		k $\Omega$	
Output Power	-3	0.8	3	dB	$GC=2.0V$ , $IQ=800mV_{p,p}$ at 100kHz
	-10	-6	-4	dB	$GC=1.5V$ , $IQ=800mV_{p,p}$ at 100kHz
	-25	-21	-19	dB	$GC=1.0V$ , $IQ=800mV_{p,p}$ at 100kHz
	-38	-35	-32	dB	$GC=0.5V$ , $IQ=800mV_{p,p}$ at 100kHz
Output Noise at $FLO+20MHz^*$		-156.4		dBm/Hz	$GC=2.0V$ , $IQ=800mV_{p,p}$ at 100kHz
		-157.2		dBm/Hz	$GC=2.0V$ , $IQ=0mV_{p,p}$
Output P1dB*		+6		dBm	IQ at 100kHz
Output IP3*		+19		dBm	$GC=2.0V$ . Extrapolated from IM3 with two baseband tones at 90kHz and 110kHz applied differentially, in quadrature, at both I and Q inputs, each tone $400mV_{p,p}$
Intermodulation IM3 tone at FLO+70kHz and FLO+130kHz relative to tone at FLO+90kHz	40	47		dBc	Two baseband tones at 90kHz and 110kHz applied at both I and Q inputs, each tone $400mV_{p,p}$
	40	49		dBc	$GC=2.0V$
	30	41		dBc	$GC=1.5V$
	25	31		dBc	$GC=1.0V$ $GC=0.5V$

\*=Not tested in production

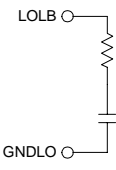
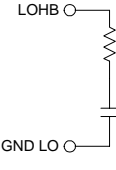
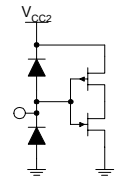
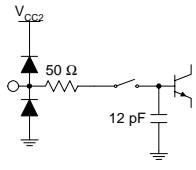

MODE	EN	BANDSEL	COMMENTS
Sleep	0	X	I/Q and GC inputs go open circuit through the use of a FET switch in sleep mode.
High Band Mode	1	1	LO input LO HB RF output=RF OUT HB
Low Band Mode	1	0	LO input LO LB RF output=RF OUT LB

Pin	Function	Description	Interface Schematic
1	VCC3	Supply for RF output circuits.	
2	VCC2	Supply for modulator and biasing circuits.	
3	ISIG P	<p>In phase I channel positive baseband input port. Best performance is achieved when the ISIGP and ISIGN are driven differentially. The recommended CW differential drive level (<math>V_{ISIGP} - V_{ISIGN}</math>) is 800mV<sub>P-P</sub>. This input should be DC-biased at 1.2V±0.05V. The common-mode DC voltage on the ISIGP and ISIGN input signals is used to bias the modulator. In sleep mode an internal FET switch is opened, the input goes high impedance and the modulator is de-biased. The input impedance is typically 5.5kΩ at low frequencies and at higher frequencies can be modeled as 50Ω in series with 12pF to ground.</p> <p>Phase or amplitude errors between the ISIGP and ISIGN signals may result in the even order distortion of the modulation in the output spectrum.</p> <p>DC offsets between the ISIGP and ISIGN signals will result in increased carrier leakage. Small DC offsets may be deliberately applied between the ISIGP/ISIGN and QSIGP/QSIGN inputs to cancel out LO leakage. The optimum corrective DC offsets will change with mode, frequency and gain control.</p> <p>Common-mode noise on the ISIGP and ISGN should be kept low as it may degrade the noise performance of the modulator.</p> <p>Phase offsets may be applied between the I and Q channels to improve the sideband suppression performance.</p>	
4	ISIG N	In phase I channel negative baseband input port. See ISIGP.	
5	ENABLE	<p>Enables power to the device.</p> <p>CMOS input.</p> <p>Logic 1 (1.4V to VCC)=Enabled.</p> <p>Logic 0 (0V to 0.5V)=Powered Down.</p>	
6	VCC1	<p>Supply for the LO buffers and quadrature network.</p> <p>The sideband suppression is a function of the VCC1 voltage. The inclusion of R3 (39Ω) lowers the voltage on VCC1 by around 400mV and results an improvement in sideband suppression but around a 0.2dB increase in noise at 20MHz offset.</p>	

Pin	Function	Description	Interface Schematic
7	LOLB	Local oscillator input low band. This input is biased internally at around 1.6V when the chip is in low band mode and 0V when the chip is in high band mode or powered down. The LO signal typically needs to be AC coupled. The noise performance, carrier suppression at low output powers and sideband suppression are all a function of LO power. The optimum LO power is between 0dBm and 3dBm. The device will work with LO powers as low as -20dBm however this is at the expense of higher noise performance at high output powers and poorer sideband suppression.	
8	GND LO	Ground return for the local oscillator input signals. The GND LO pin is effectively the complementary LO input for both the high band and low band LO signals. It has significant amounts of LO signal flowing through it. This pin is brought out as an independent ground to enable the PCB board designer to isolate the LO return from the RF outputs ground and the general chip ground. It is recommended that this ground is kept isolated from the die flag ground. Any connections between the GND LO and any other ground should be made through a ground plane.	See pins 7 and 9.
9	LOHB	Local oscillator input high band. This input is biased internally at around 1.6V when the chip is in high band mode and 0V when the chip is in low band mode or powered down. The LO HB signal typically needs to be AC coupled. The noise performance, carrier suppression at low output powers and sideband suppression are all a function of LO power. The optimum LO power is between 0dBm and 3dBm. The device will work with LO powers as low as -20dBm however this is at the expense of higher noise performance at high output powers and poorer sideband suppression.	
10	GND1	Ground for LO buffers.	See pin 6.
11	BAND SEL	Band select input to define active mode. CMOS input. Logic 1 (1.4V to VCC)=High band mode. Logic 2 (0V to 0.5V)=Low band mode.	
12	QSIG N	Quadrature channel negative baseband input port. See QSIGP.	

Pin	Function	Description	Interface Schematic
13	QSIG P	<p>Quadrature Q channel positive baseband input port. Best performance is achieved when the ISIGP and ISIGN are driven differentially. The recommended CW differential drive level (<math>V_{QSIGP} - V_{QSIGN}</math>) is 800mV<sub>P-P</sub>.</p> <p>This input should be DC-biased at 1.2V±0.05V. The common-mode DC voltage on the QSIGP and QSIGN input signals is used to bias the modulator. In sleep mode an internal FET switch is opened, the input goes high impedance and the modulator is de-biased. The input impedance is typically 5.5kΩ at low frequencies and at higher frequencies can be modeled as 50Ω in series with 12pF to ground.</p> <p>Phase or amplitude errors between the QSIGP and QSIGN signals which may result in an increase in the even order distortion of the modulation in the output spectrum.</p> <p>DC offsets between the QSIGP and QSIGN signals will result in an increased carrier leakage. Small DC offsets may be deliberately applied between the ISIGP/ISIGN and QSIGP/QSIGN inputs to cancel out the LO leakage. The optimum corrective DC offsets will change with mode, frequency and gain control.</p> <p>Common-mode noise on the QSIGP and QSIGN should be kept low as it may degrade the noise performance of the modulator.</p> <p>Phase offsets may be applied between the I and Q channels to improve the sideband suppression performance.</p>	
14	VREF	<p>Voltage reference decouple with an external 10nF capacitor to ground. The voltage on this pin is typically 1.67V when the chip is enabled. The voltage is 0V when the chip is powered down.</p> <p>The purpose of this decoupling capacitor is to filter out low frequency noise (20MHz) on the gain control lines.</p> <p>Poor positioning of the VREF decoupling capacitor can cause a degradation in LO leakage.</p> <p>A voltage of around 2.5V on this pin indicates that the die flag under the chip is not grounded and the chip is not biased correctly.</p>	
15	GC DEC	<p>Voltage reference decouple with an external 1nF decoupling capacitor to ground.</p> <p>The voltage on this pin is a function of gain control (GC) voltage when the chip is enabled. The voltage is 0V when the chip is powered down.</p> <p>The purpose of this decoupling capacitor is to filter out low frequency noise (20MHz) on the gain control lines. The size of the capacitor on the GC DEC line will effect the settling time response to a change in gain control voltage. A 1nF capacitor equates to around 200ns settling time and a 0.5nF capacitor equates to a 100ns settling time. There is a trade-off between settling time and noise contributions by the gain control circuitry as gain control is applied.</p> <p>Poor positioning of the VREF decoupling capacitor can cause a degradation in LO leakage.</p>	
16	GC	<p>Gain control voltage. Maximum output power at 2.0V. Minimum output power at 0V. When the chip is enabled the input impedance is 10kΩ referenced to 1.7V<sub>DC</sub>. When the chip is powered down a FET switch is opened and the input goes high impedance.</p>	
17	RF OUT LB	<p>RF low band output. Open collector output.</p> <p>The output should be biased at VCC through an inductor that can be used to form part of an output matching circuit.</p> <p>In our proposed applications circuit some power is dissipated in R6 (130Ω) which appears as a de-Qing resistor in parallel with the output inductor L4. If R6 is eliminated and the RFOUT LB pin is re-matched to 50Ω it is possible to get approximately 5dB extra power out of the device in low band mode.</p>	
18	GND2	Ground for RF output sections.	



Pin	Function	Description	Interface Schematic
19	RF OUT HB	RF high band output. Open collector output. The output should be biased at VCC through an inductor that can be used to form part of an output matching circuit. In our proposed applications circuit some power is dissipated in R4 (180Ω) which appears as a de-Qing resistor in parallel with the output inductor L3. If R4 is eliminated and the RFOUT HB pin is re-matched to 50Ω it is possible to get approximately 3dB extra power out of the device in high band mode.	
20	GND3	Ground for RF output sections.	
Die Flag	GND4	Ground for modulator, variable gain amplifier and substrate.	

## Application Notes

The baseband inputs must be driven with balanced differential signals. We suggest amplitude and phase matching  $<0.5\text{dB}$  and  $<0.5^\circ$ . Phase or gain imbalances between the complementary input signals will cause additional distortion including some second order baseband distortion.

The common-mode voltage on the baseband inputs should be well controlled at 1.2V. We suggest that the common-mode DC voltage be  $1.2\text{V} \pm 0.05\text{V}$ . The common-mode DC voltage is used to bias the modulator; hence, deviations from 1.2V will result in changes in the current consumption, noise and intermodulation performance.

The chip is designed to be driven with a single-ended LO signal.

The GC DEC and VREF output pins should be decoupled to ground. We recommend a 10nF capacitor on VREF, and a 1nF capacitor on GC DEC. The purpose of this capacitor is to filter out low frequency noise (20MHz) in the gain control lines, which may cause noise on the RF signal. The capacitor on the GC DEC line will effect the settling time response to a change in power control voltage. A 1nF capacitor equates to around a 200ns settling time, and a 0.5nF capacitor equates to a 100ns settling time. There is a trade-off between settling time and phase noise as you start to apply gain control.

The ground lines for the LO sections, GNDLO and GND1, are brought out of the chip independently from the ground to the RF and modulator sections. This isolates the LO signals from the RF output sections.

The GND LO pin is effectively the complementary LO input for both the high band and low band LO signals. It has significant amounts of LO signal flowing through it. This is brought out as an independent ground to try to enable the PCB board designer to isolate the LO return from the RF output sections and general chip ground.

The RF output ports of the RF2483 consist of open collector architecture and require pull up inductors to the supply voltage. This, in conjunction with a DC blocking capacitor provides a simple, broadband L-match network as shown in the schematic diagram. A shunt resistor is included to control the Q of the matching network and set the modulator output power. In this case, both outputs were designed to provide 0dBm.

An alternate output match containing a third harmonic trap was evaluated. This circuit uses a tapped-C matching network, whereby the shunt C provides a low impedance path near the third harmonic frequency. Although an additional component is required, the benefit of suppressing the third harmonic distortion may improve overall system intermodulation. This network has been shown to provide better than 20dB of improved suppression in high-band mode.

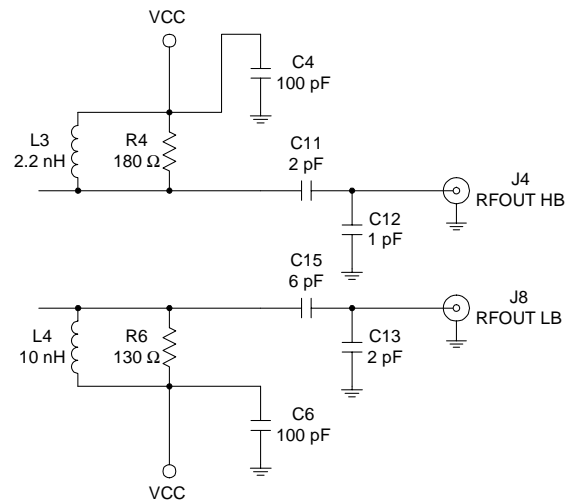

**Figure 1. Alternate RF output match with third-harmonic suppression.**

### High Band LOHB (S11) and RFHB (S22) Parameters ( $V_{CC}=2.7\text{V}$ , $V_{GC}=2.0\text{V}$ , Band Sel=2.7V, EN=2.7V, $T=+25^\circ\text{C}$ )

Freq. (MHz)	S11 MAG	S11 ANG	S22 MAG	S22 ANG
1700	0.478	-110.8	0.903	-55.0
1750	0.469	-112.4	0.901	-56.2
1800	0.465	-115.1	0.902	-57.2
1850	0.472	-117.2	0.902	-58.0
1900	0.476	-117.6	0.904	-59.0
1950	0.465	-118.4	0.905	-59.6
2000	0.457	-120.8	0.906	-60.3
2050	0.452	-122.6	0.909	-60.9
2100	0.464	-123.0	0.916	-61.9
2150	0.453	-123.4	0.914	-64.0
2200	0.442	-125.4	0.879	-64.5

### Low Band LOLB (S11) and RFLB (S22) Parameters ( $V_{CC}=2.7\text{V}$ , $V_{GC}=2.0\text{V}$ , Band Sel=0V, EN=2.7V, $T=+25^\circ\text{C}$ )

Freq. (MHz)	S11 MAG	S11 ANG	S22 MAG	S22 ANG
700	0.468	-63.2	0.92	-9.9
750	0.452	-67.6	0.915	-11.3
800	0.437	-72.1	0.913	-12.6
850	0.425	-76.6	0.908	-14.0
900	0.414	-81.2	0.905	-15.6
950	0.407	-85.6	0.901	-17.1
1000	0.402	-89.8	0.898	-18.8

Evaluation Board Schematic  
(Download [Bill of Materials](http://www.rfmd.com) from www.rfmd.com.)

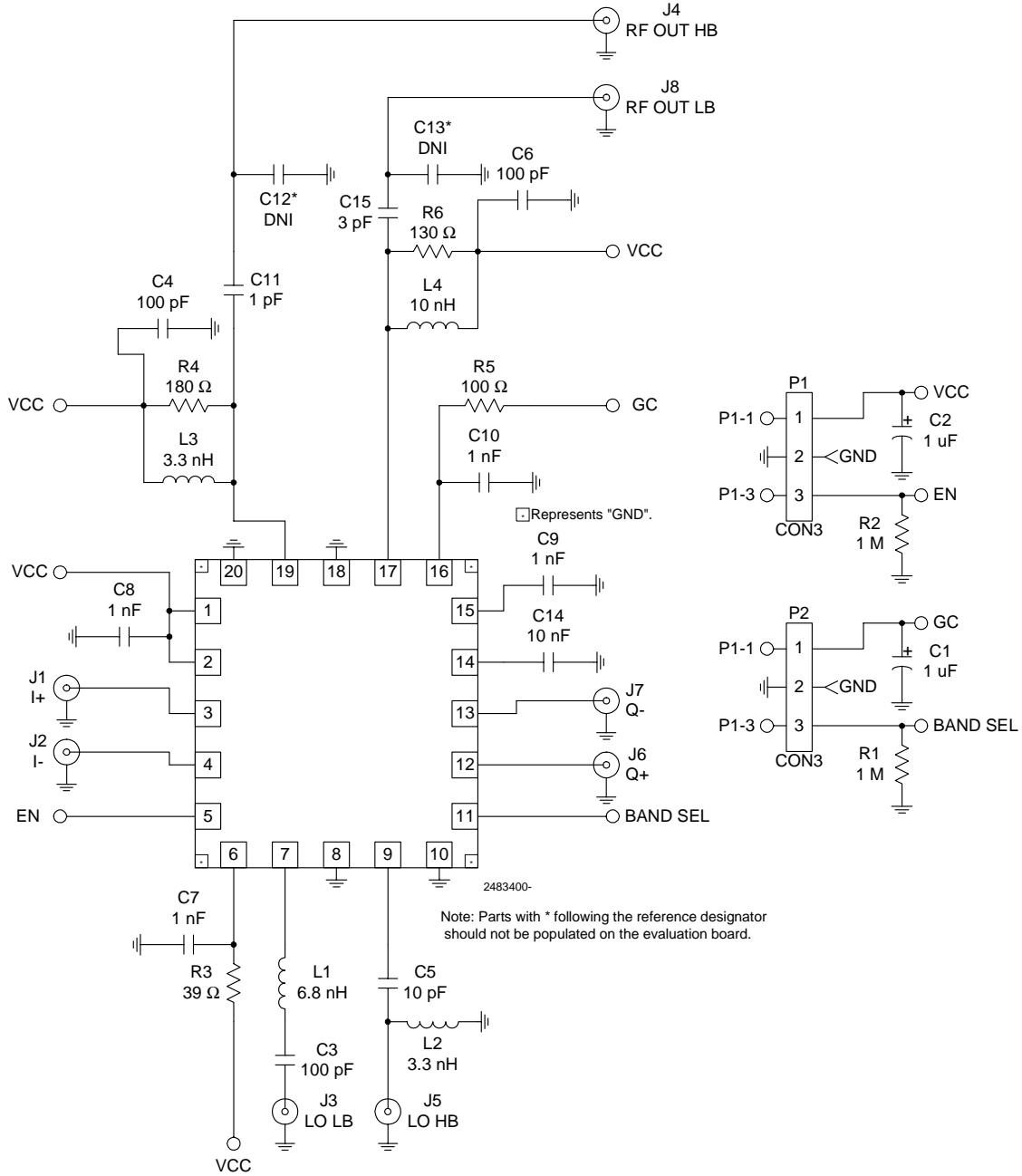

Evaluation Board Layout

Board Size 2.0" x 2.0"

Board Thickness 0.062", Board Material FR-4, Multi-Layer

Assembly

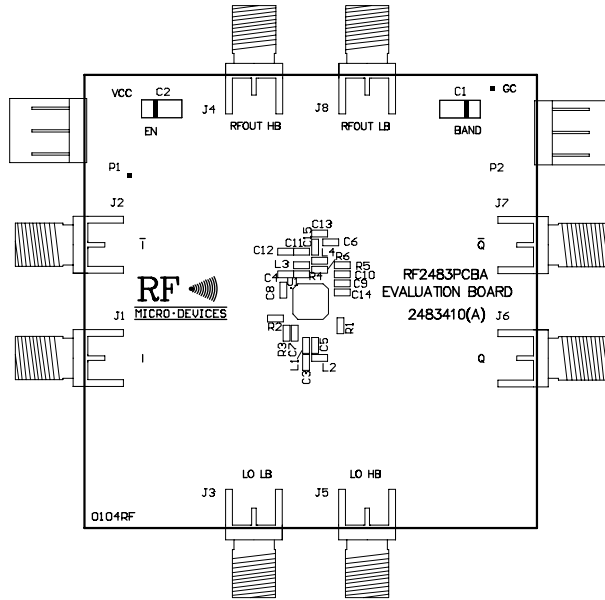

Top

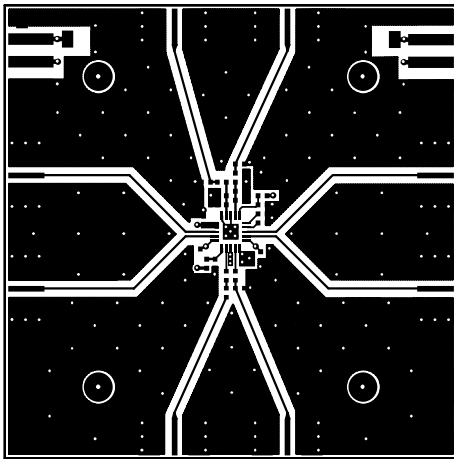

Inner 1

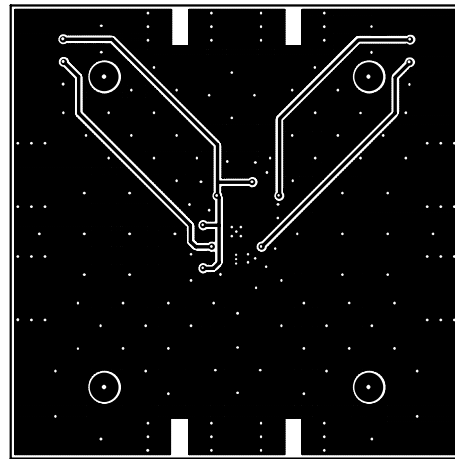

Inner 2

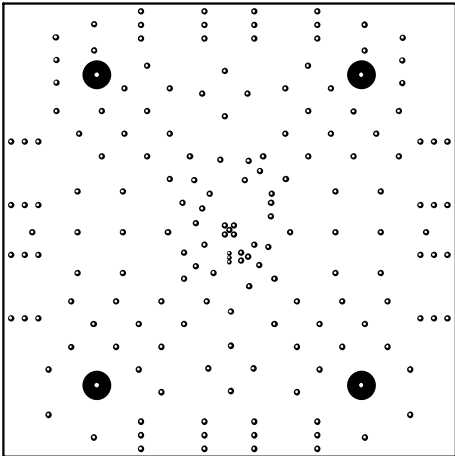

Back

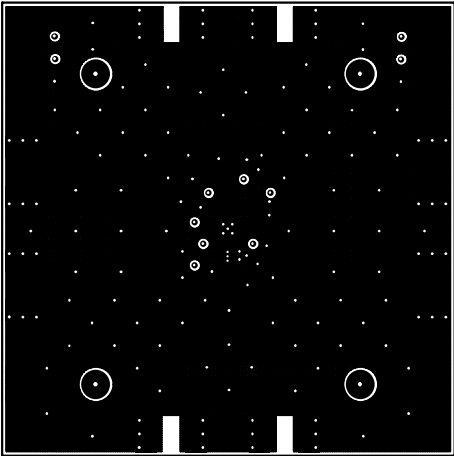

**High Band Modulator Performance versus Frequency**

LO=0dBm, V<sub>CC</sub>=2.7V, GC=2V, IQ=100kHz 800mV<sub>P-P</sub>

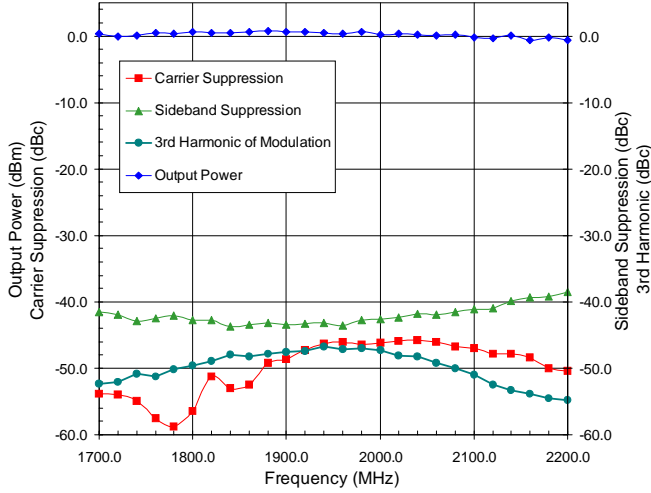

**High Band Modulator Performance versus LO Power**

LO=1900MHz, V<sub>CC</sub>=2.7V, GC=2V, IQ=100kHz 800mV<sub>P-P</sub>

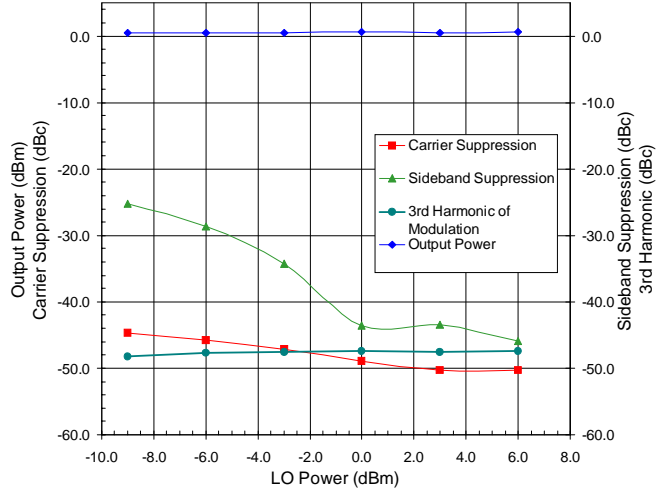

**High Band Output Noise 20MHz Offset versus LO Power**

V<sub>CC</sub>=2.7V, LO=1900MHz, GC=2V

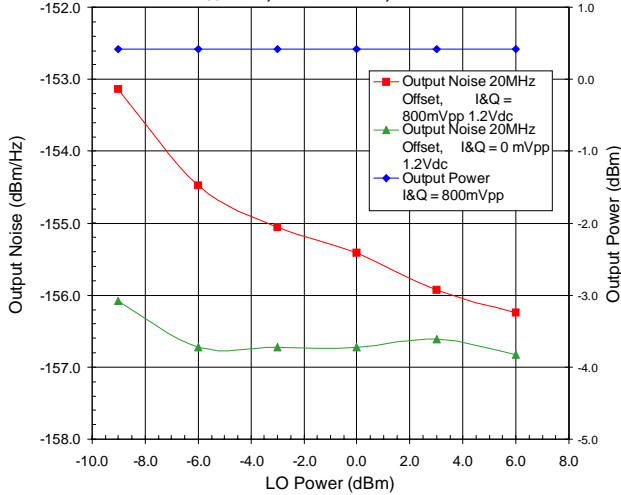

**High Band Output Power versus Baseband Signal Level -**

V<sub>CC</sub>=2.7V, LO=1900MHz 0dBm, IQ=100kHz 1.2Vdc

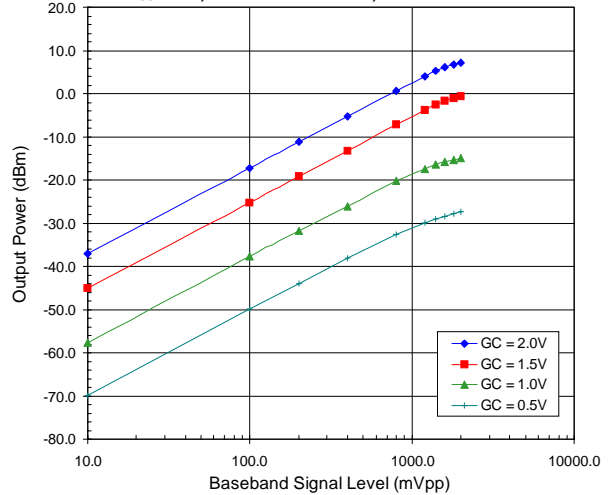

**High Band Output Noise 20MHz Offset versus Gain Control -**

V<sub>CC</sub>=2.7V, LO=1900MHz, GC=2V

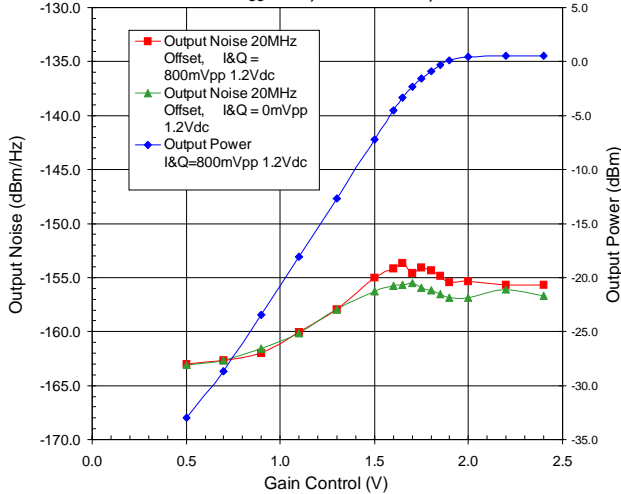

**High Band Output IP3 versus Gain Control**

V<sub>CC</sub>=2.7V, LO=0dBm, IQ=900kHz and 1100kHz at 1.2Vdc

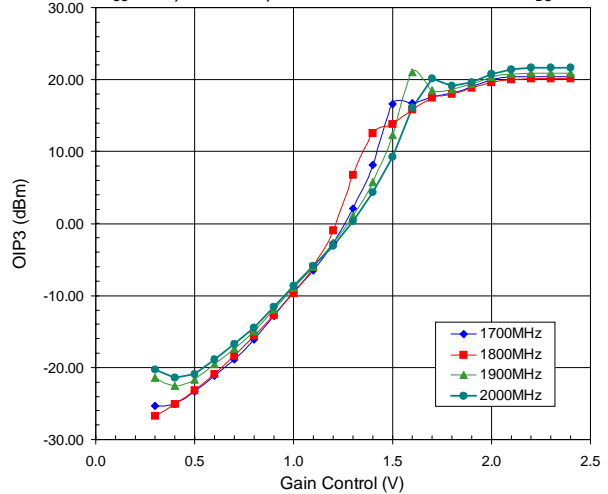

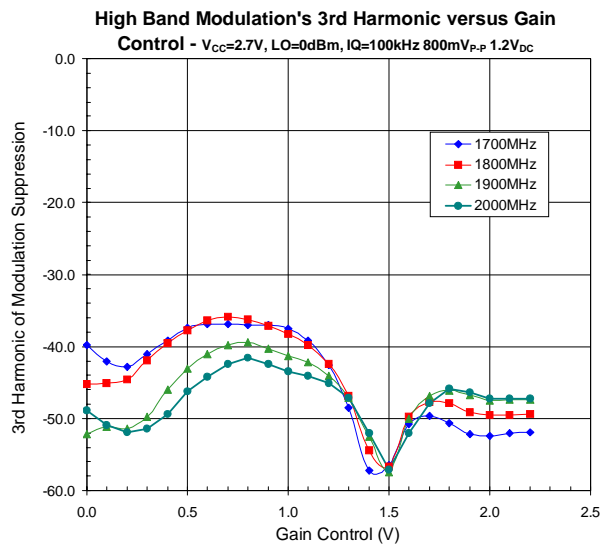
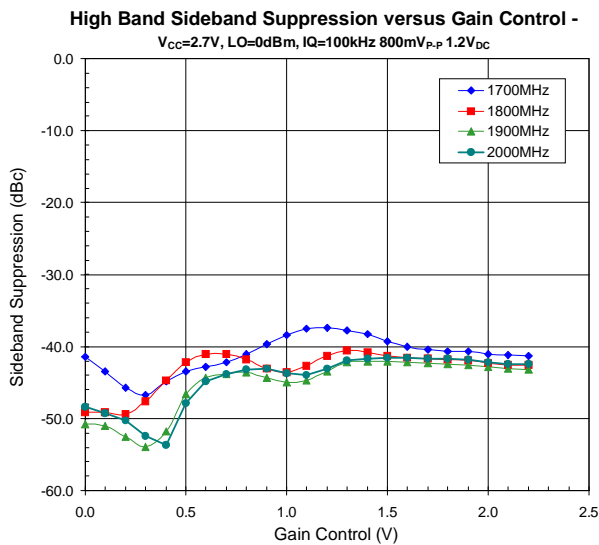
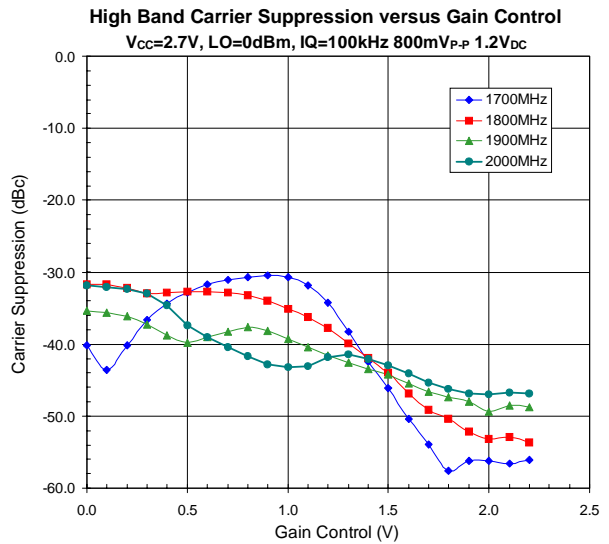
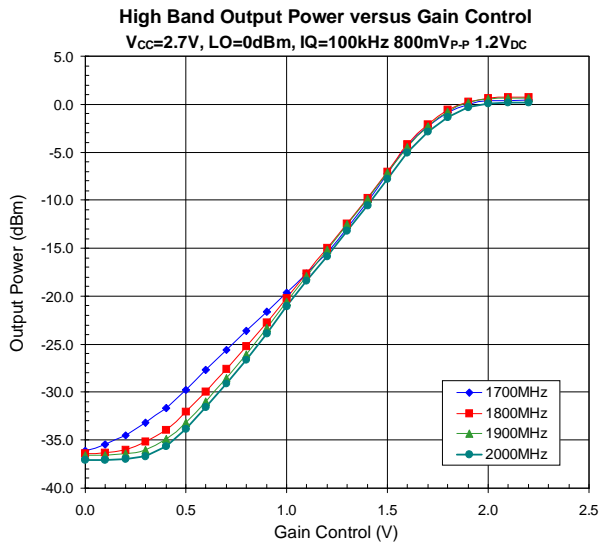
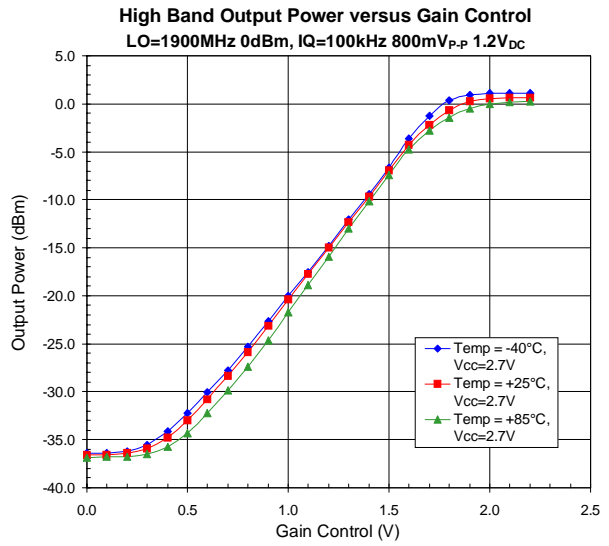
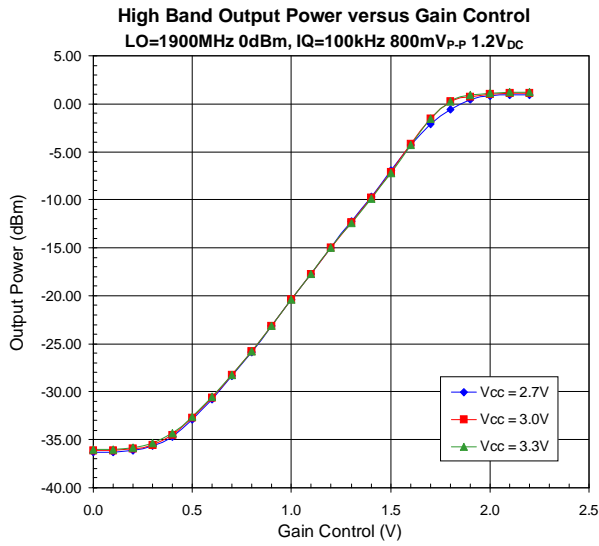

**High Band Carrier Suppression versus Gain Control**  
LO=1900MHz 0dBm, IQ=100kHz 800mV<sub>p-p</sub> 1.2V<sub>DC</sub>

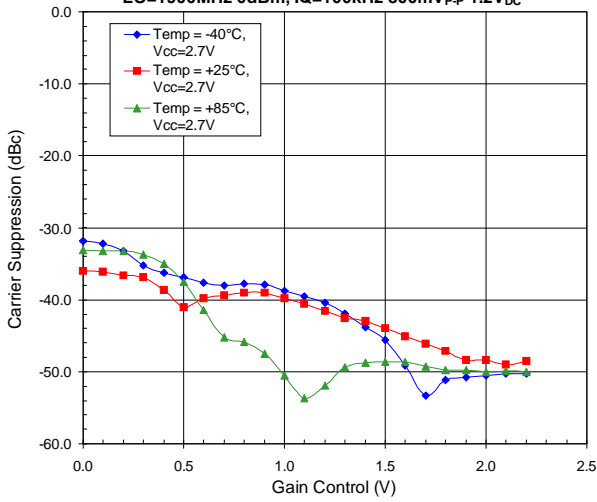

**High Band Sideband Suppression versus Gain Control -**  
LO=1900MHz 0dBm, IQ=100kHz 800mV<sub>p-p</sub> 1.2V<sub>DC</sub>

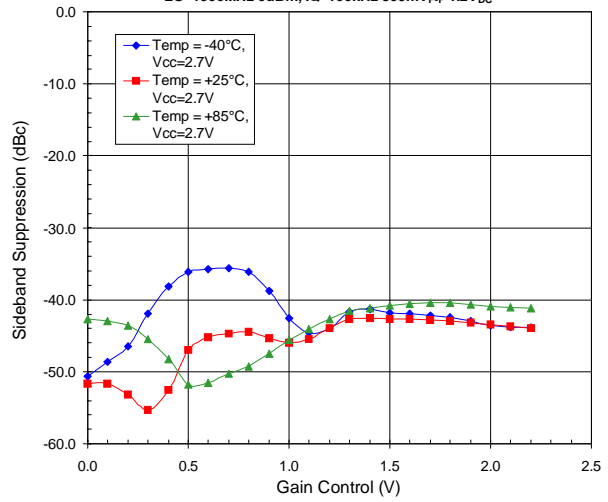

**High Band Sideband Suppression versus Gain Control -**  
Vcc=2.7V, LO=0dBm, IQ=100kHz 800mV<sub>p-p</sub> 1.2V<sub>DC</sub>

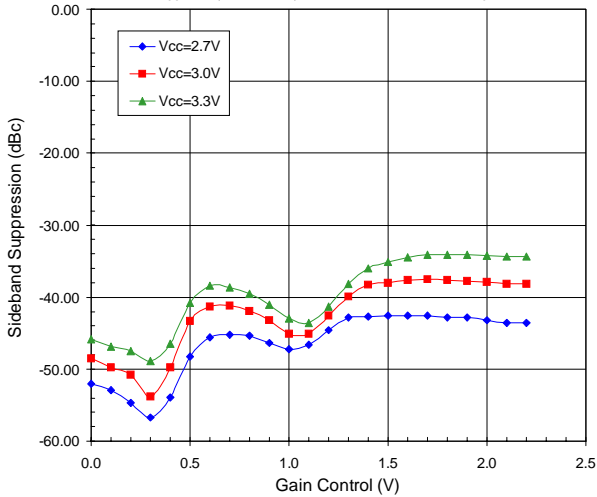

**High Band Carrier Suppression versus Gain Control**  
Vcc=2.7V, LO=0dBm, IQ=100kHz 800mV<sub>p-p</sub> 1.2V<sub>DC</sub>

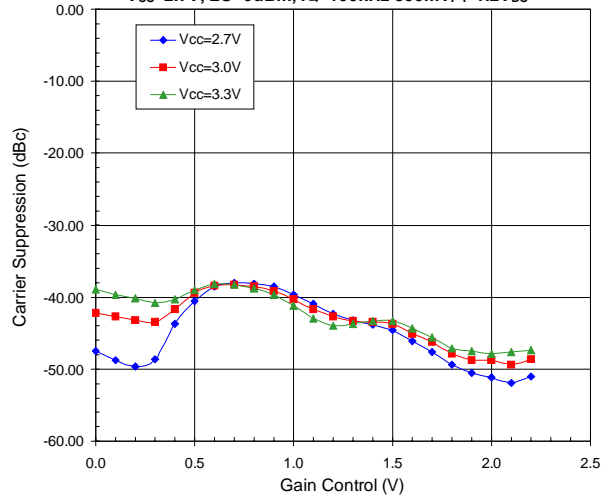

**High Band Modulation's 3rd Harmonic versus Gain Control**  
Control - LO=1900MHz 0dBm, IQ=100kHz 800mV<sub>p-p</sub> 1.2V<sub>DC</sub>

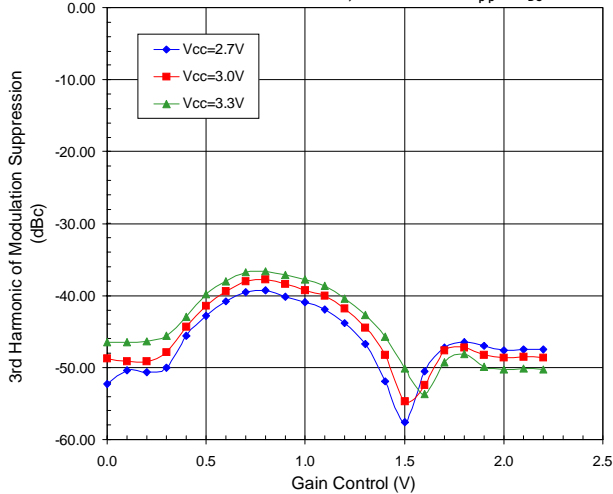

**High Band Output IP3 versus Gain Control**  
LO=1900MHz 0dBm, IQ=900kHz and 1100kHz at 1.2V<sub>DC</sub>

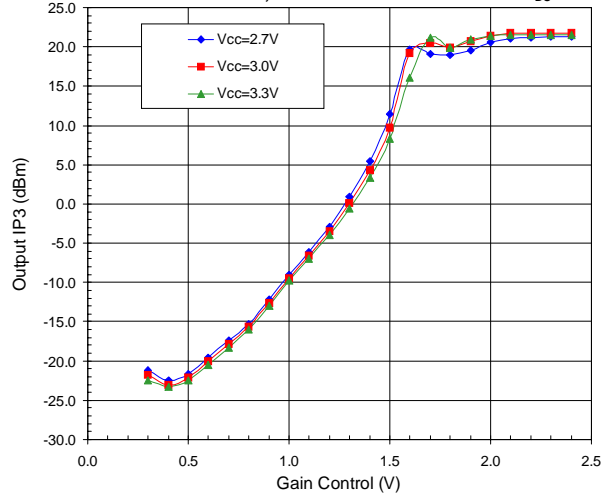



**Low Band Modulator Performance versus Frequency**  
 LO=0dBm, V<sub>CC</sub>=2.7V, GC=2V, IQ=100kHz 800mV<sub>P-P</sub>

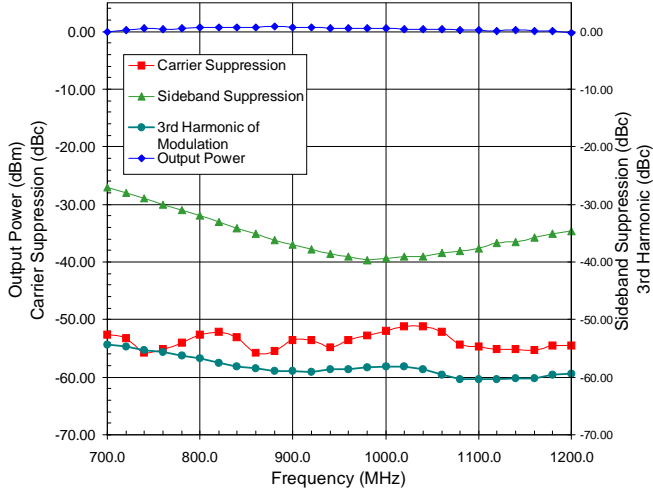

**Low Band Modulator Performance versus LO Power**  
 LO=900MHz, V<sub>CC</sub>=2.7V, GC=2V, IQ=100kHz 800mV<sub>P-P</sub>

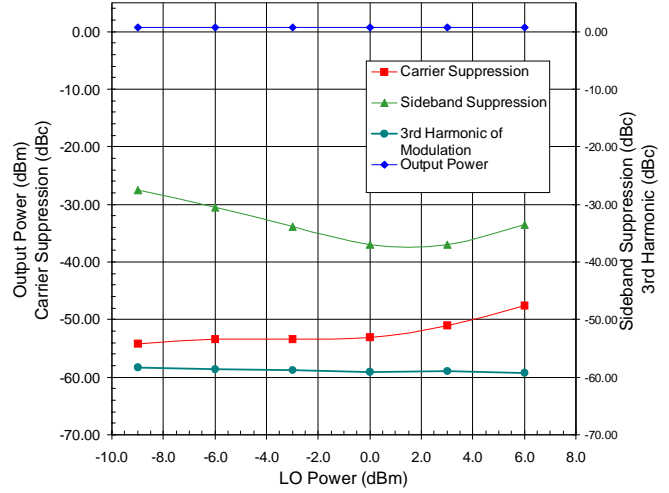

**Low Band Output Noise 20MHz Offset versus LO Power**  
 V<sub>CC</sub>=2.7V, LO=900MHz, GC=2V

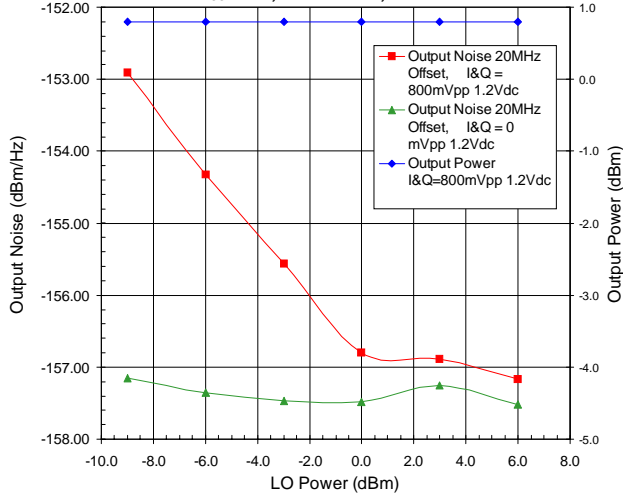

**Low Band Output Power versus Baseband Signal Level**  
 V<sub>CC</sub>=2.7V, LO=900MHz, IQ=100kHz 1.2Vdc

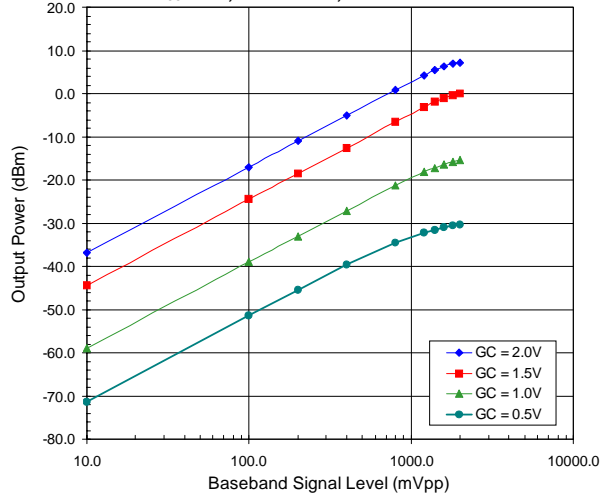

**Low Band Output Noise at 20MHz Offset versus GC**  
 V<sub>CC</sub>=2.7V, LO=900MHz 0dBm

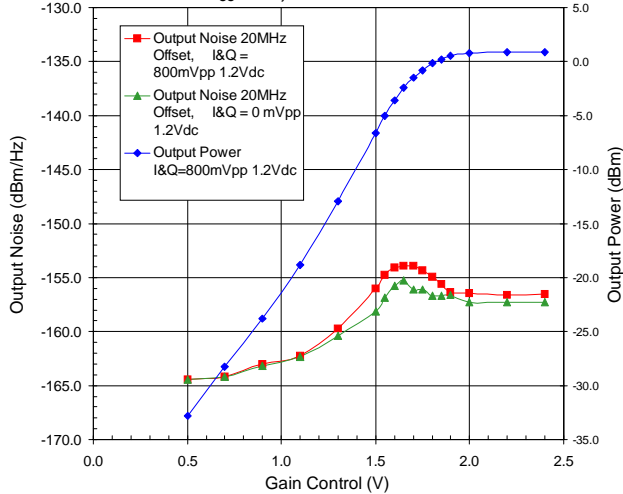

**Low Band Output IP3 versus Gain Control**

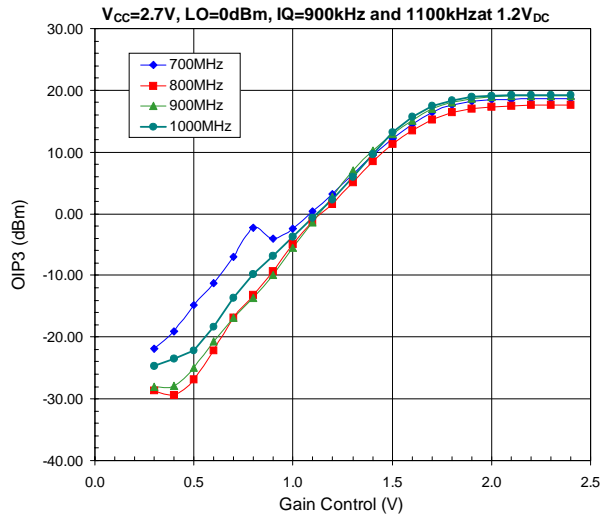

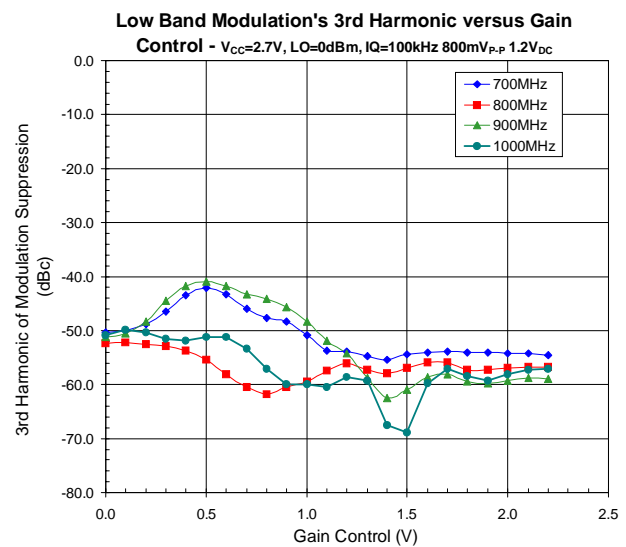
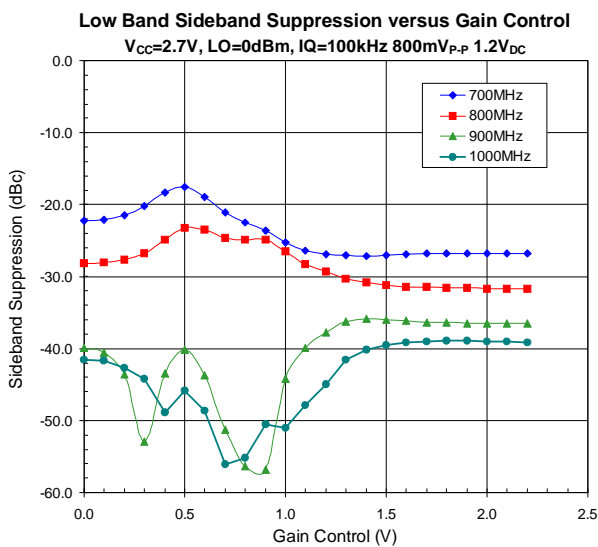
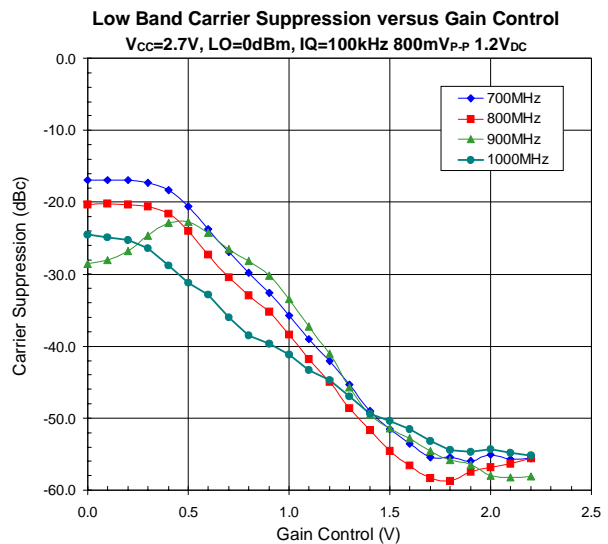
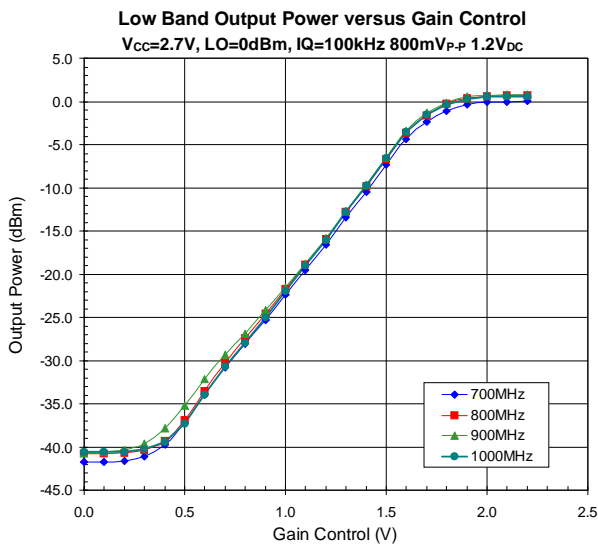
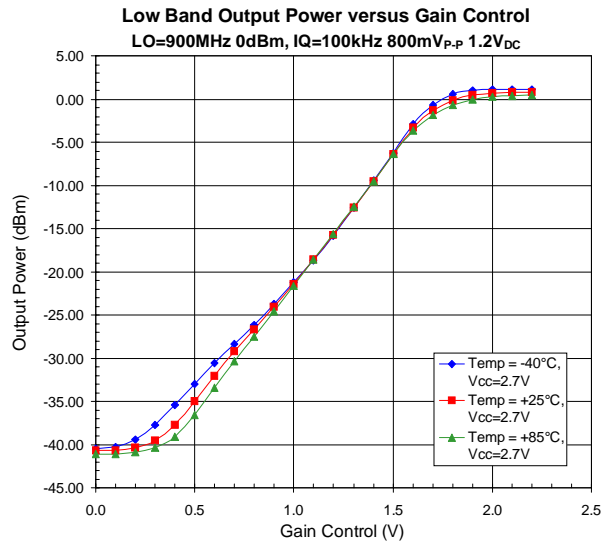
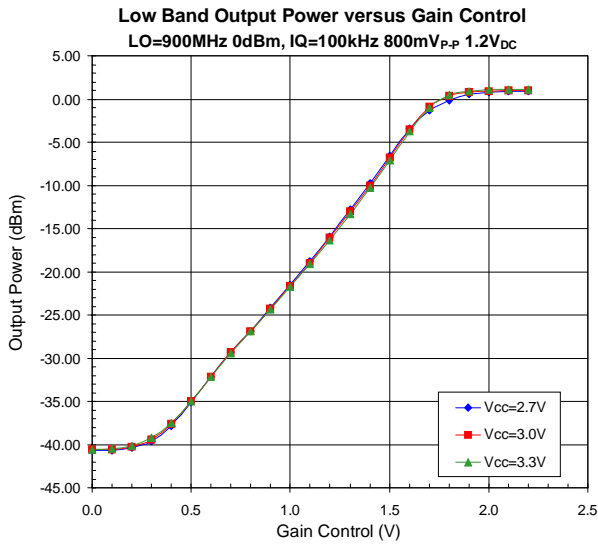

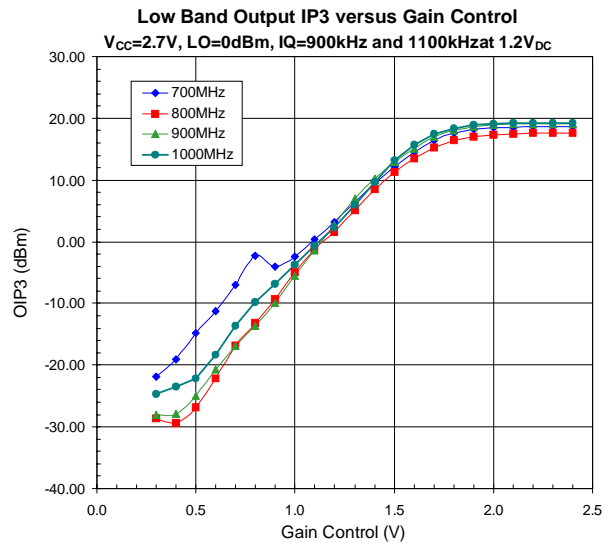
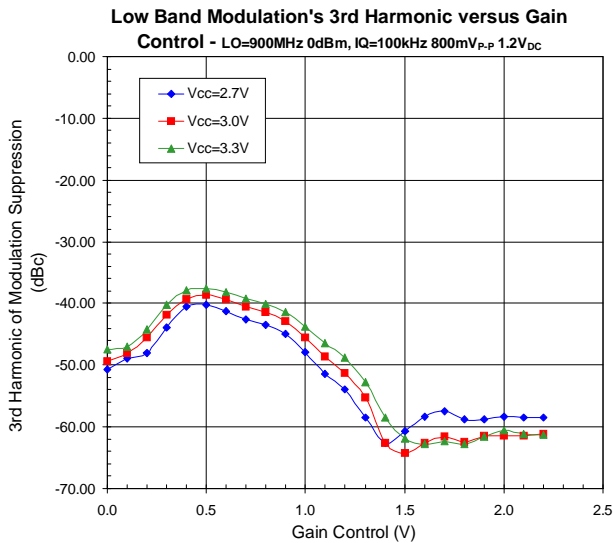
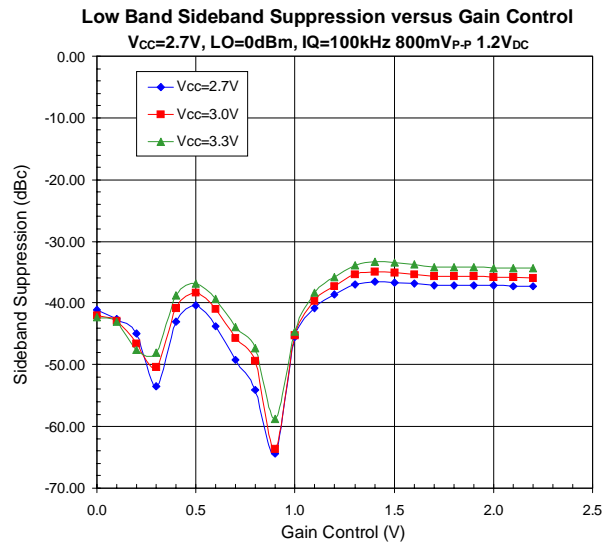
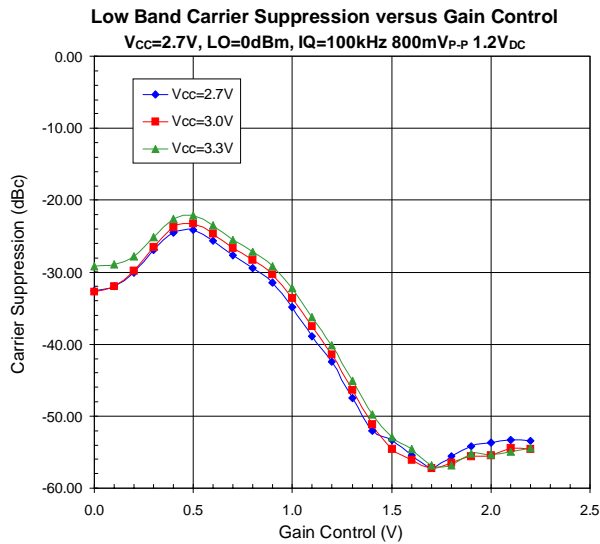
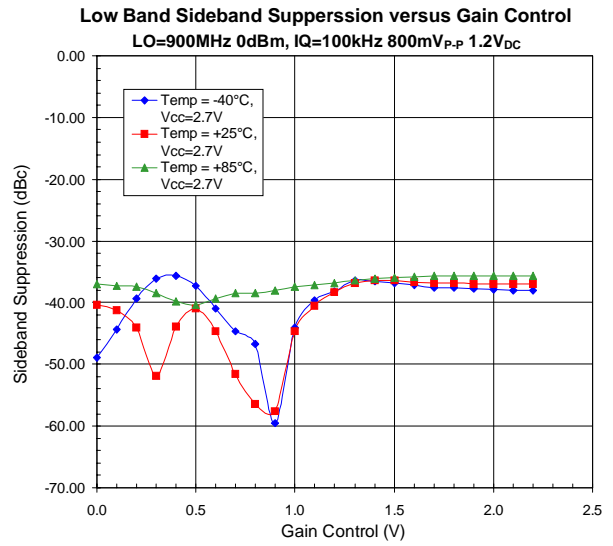
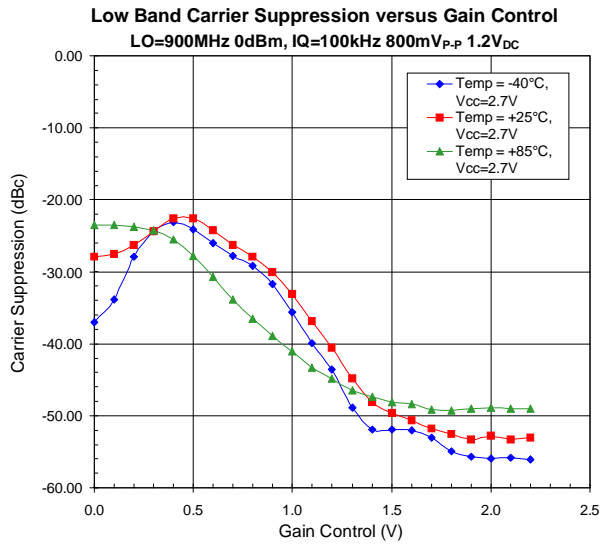

**High Band Current Consumption versus Gain Control**  
LO=1900MHz 0dBm, IQ=100kHz 800mV<sub>P-P</sub> 1.2V<sub>DC</sub>

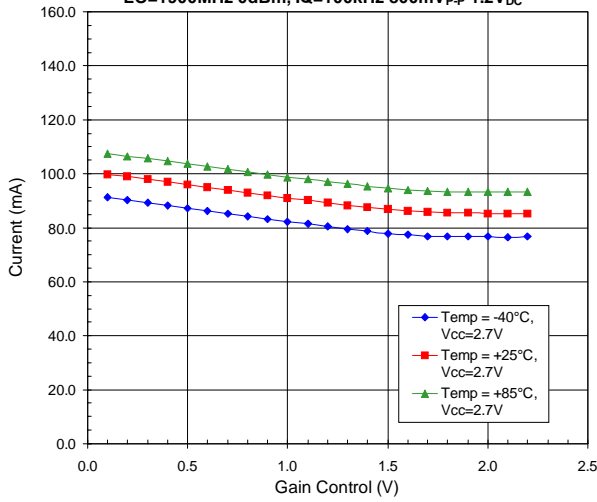

**Low Band Current Consumption versus Gain Control**  
LO=900MHz 0dBm, IQ=100kHz 800mV<sub>P-P</sub> 1.2V<sub>DC</sub>

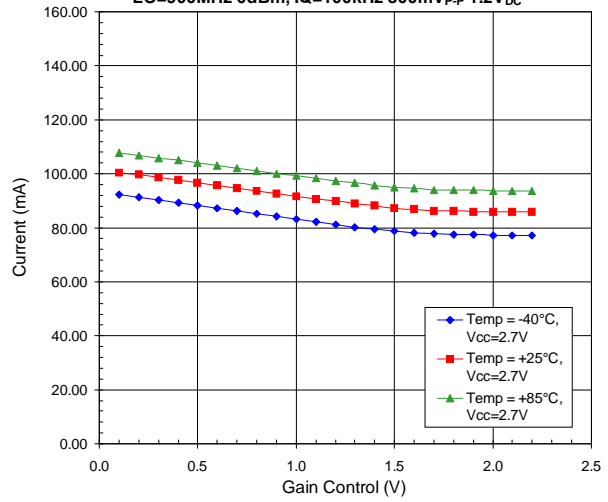

**High Band Current Consumption versus Gain Control**  
LO=1900MHz 0dBm, IQ=100kHz 800mV<sub>P-P</sub> 1.2V<sub>DC</sub>

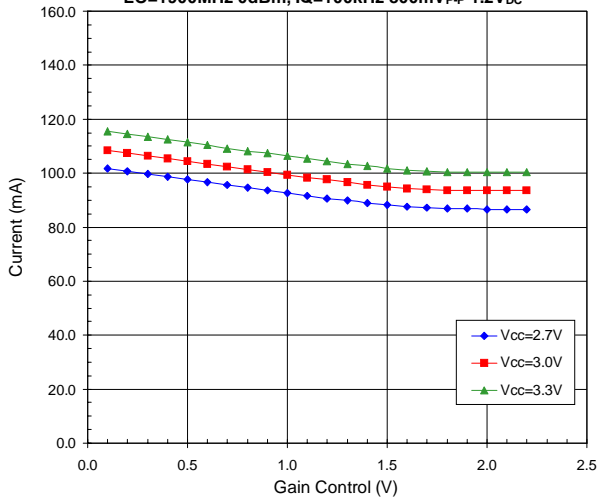

**Low Band Current Consumption versus Gain Control**  
LO=900MHz 0dBm, IQ=100kHz 800mV<sub>P-P</sub> 1.2V<sub>DC</sub>

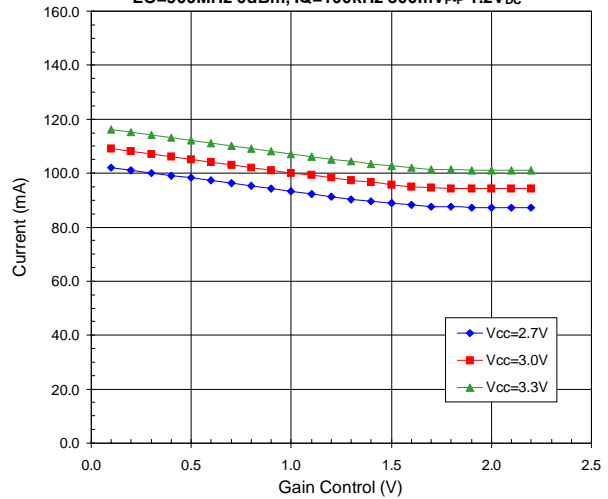

**High Band Return Loss versus Frequency**

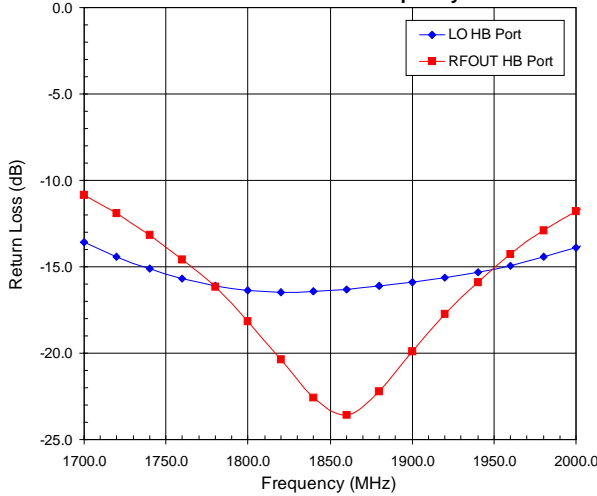

**Low Band Return Loss versus Frequency**

