

2SC3976

Silicon NPN triple diffusion planar type

For high breakdown voltage high-speed switching

Features

- High-speed switching
- High collector to base voltage V_{CBO}
- Wide area of safe operation (ASO)
- Satisfactory linearity of forward current transfer ratio h_{FE}

Absolute Maximum Ratings ($T_C=25^\circ\text{C}$)

| Parameter | Symbol | Rated | Unit | |
|------------------------------|-----------|------------------------|------------------|---|
| Collector to base voltage | V_{CBO} | 800 | V | |
| Collector to emitter voltage | V_{CES} | 800 | V | |
| | V_{CEO} | 500 | V | |
| Emitter to base voltage | V_{EBO} | 8 | V | |
| Peak collector current | I_{CP} | 25 | A | |
| Collector current | I_C | 12 | A | |
| Base current | I_B | 6 | A | |
| Collector power dissipation | P_C | $T_C=25^\circ\text{C}$ | 150 | W |
| | | $T_a=25^\circ\text{C}$ | 3.5 | |
| Junction temperature | T_j | 150 | $^\circ\text{C}$ | |
| Storage temperature | T_{stg} | -55 to +150 | $^\circ\text{C}$ | |

Electrical Characteristics ($T_C=25^\circ\text{C}$)

| Parameter | Symbol | Conditions | min | typ | max | Unit |
|---|---------------|--|-----|-----|-----|---------------|
| Collector cutoff current | I_{CBO} | $V_{CB} = 800\text{V}, I_E = 0$ | | | 100 | μA |
| Emitter cutoff current | I_{EBO} | $V_{EB} = 5\text{V}, I_C = 0$ | | | 100 | μA |
| Collector to emitter voltage | V_{CEO} | $I_C = 10\text{mA}, I_B = 0$ | 500 | | | V |
| Forward current transfer ratio | h_{FE1} | $V_{CE} = 5\text{V}, I_C = 0.1\text{A}$ | 15 | | | |
| | h_{FE2} | $V_{CE} = 5\text{V}, I_C = 7\text{A}$ | 8 | | | |
| Collector to emitter saturation voltage | $V_{CE(sat)}$ | $I_C = 7\text{A}, I_B = 1.4\text{A}$ | | | 1.0 | V |
| Base to emitter saturation voltage | $V_{BE(sat)}$ | $I_C = 7\text{A}, I_B = 1.4\text{A}$ | | | 1.5 | V |
| Transition frequency | f_T | $V_{CE} = 10\text{V}, I_C = 1\text{A}, f = 1\text{MHz}$ | | 15 | | MHz |
| Turn-on time | t_{on} | $I_C = 7\text{A}, I_{B1} = 1.4\text{A}, I_{B2} = -2.8\text{A}, V_{CC} = 200\text{V}$ | | | 1.0 | μs |
| Storage time | t_{stg} | | | | 3.0 | μs |
| Fall time | t_f | | | | 0.3 | μs |

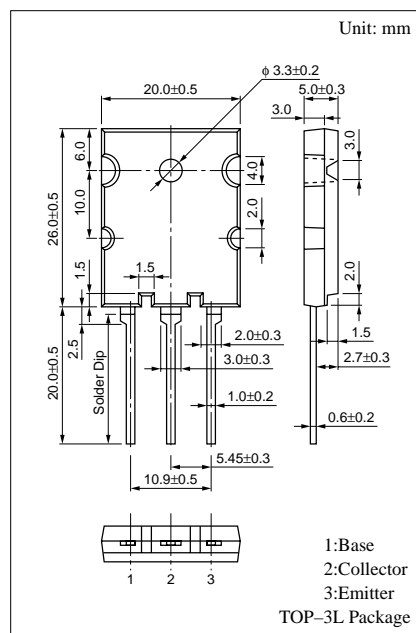

$P_C - T_a$

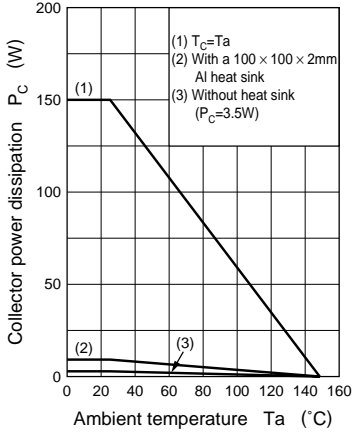

$I_C - V_{CE}$

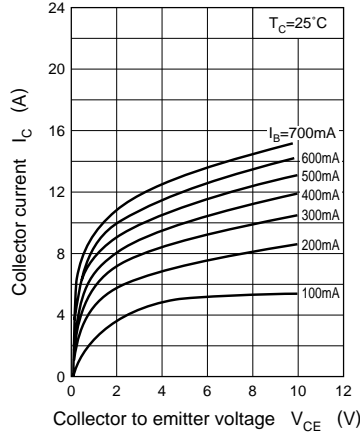

$V_{CE(sat)} - I_C$

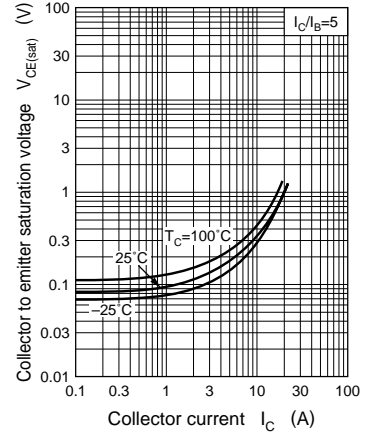

$V_{BE(sat)} - I_C$

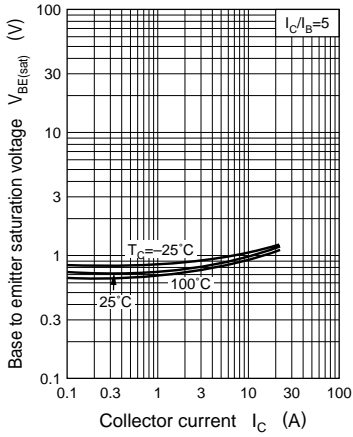

$h_{FE} - I_C$

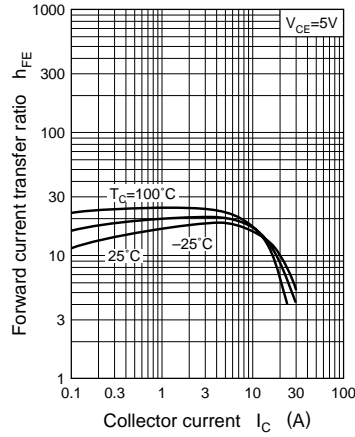

$f_T - I_C$

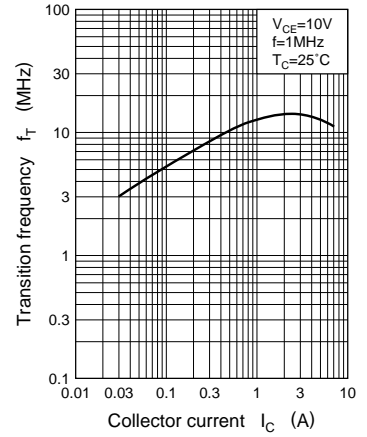

$C_{ob} - V_{CB}$

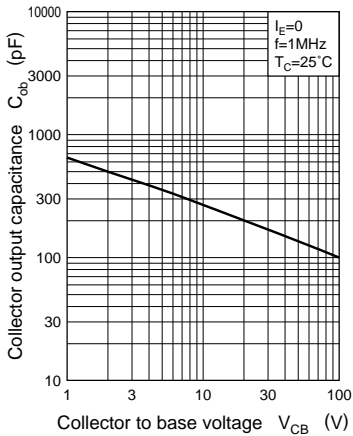

$t_{on}, t_{stg}, t_f - I_C$

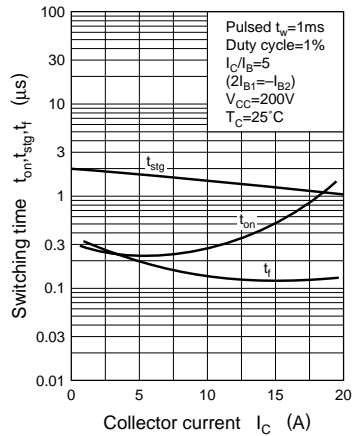

Area of safe operation (ASO)

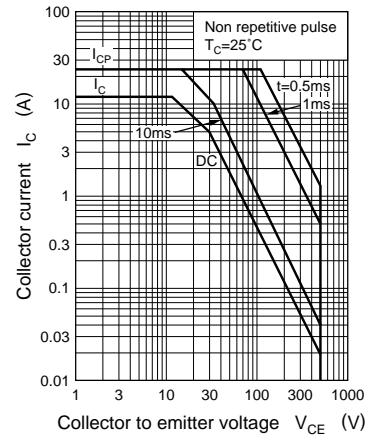

Area of safe operation, reverse bias ASO

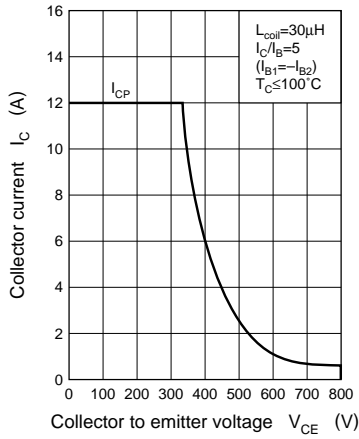

Reverse bias ASO measuring circuit

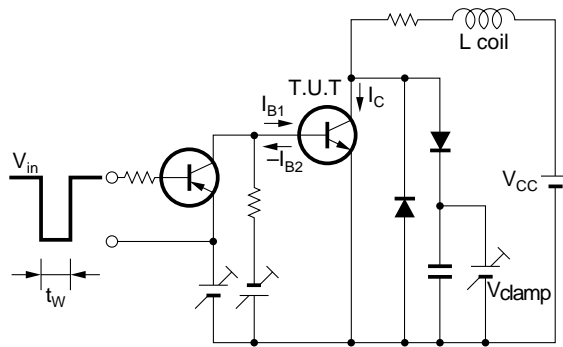

$R_{th(t)} - t$

