

N-Channel MOSFET

Features

- $R_{DS(on)}$ (Max 2.5 Ω)@ $V_{GS}=10V$
- Gate Charge (Typical 15nC)
- Improved dv/dt Capability, High Ruggedness
- 100% Avalanche Tested
- Maximum Junction Temperature Range (150°C)

General Description

This Power MOSFET is produced using Wisdom's advanced planar stripe, DMOS technology. This latest technology has been especially designed to minimize on-state resistance, have a high rugged avalanche characteristics. These devices are well suited for high efficiency switch mode power supplies, active power factor correction, electronic lamp ballasts based on half bridge topology.

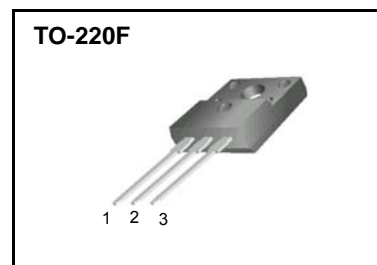
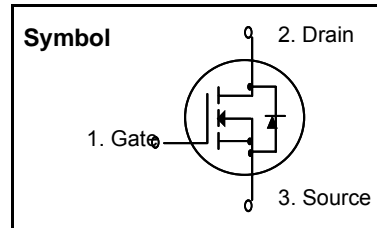

Absolute Maximum Ratings (* Drain current limited by junction temperature)

Symbol	Parameter	Value	Units
V_{DSS}	Drain to Source Voltage	600	V
I_D	Continuous Drain Current(@ $T_C = 25^\circ C$)	4.0*	A
	Continuous Drain Current(@ $T_C = 100^\circ C$)	2.5*	A
I_{DM}	Drain Current Pulsed (Note 1)	16*	A
V_{GS}	Gate to Source Voltage	± 30	V
E_{AS}	Single Pulsed Avalanche Energy (Note 2)	240	mJ
E_{AR}	Repetitive Avalanche Energy (Note 1)	10	mJ
dv/dt	Peak Diode Recovery dv/dt (Note 3)	4.5	V/ns
P_D	Total Power Dissipation(@ $T_C = 25^\circ C$)	33	W
	Derating Factor above 25 °C	0.26	W/°C
T_{STG}, T_J	Operating Junction Temperature & Storage Temperature	- 55 ~ 150	°C
T_L	Maximum Lead Temperature for soldering purpose, 1/8 from Case for 5 seconds.	300	°C

Thermal Characteristics

Symbol	Parameter	Value			Units
		Min.	Typ.	Max.	
$R_{\theta JC}$	Thermal Resistance, Junction-to-Case	-	-	3.79	°C/W
$R_{\theta JA}$	Thermal Resistance, Junction-to-Ambient	-	-	62.5	°C/W

WFF4N60

Electrical Characteristics (T_C = 25 °C unless otherwise noted)

Symbol	Parameter	Test Conditions	Min	Typ	Max	Units
Off Characteristics						
BV _{DSS}	Drain-Source Breakdown Voltage	V _{GS} = 0V, I _D = 250uA	600	-	-	V
$\frac{\Delta BV_{DSS}}{\Delta T_J}$	Breakdown Voltage Temperature coefficient	I _D = 250uA, referenced to 25 °C	-	0.6	-	V/°C
I _{DSS}	Drain-Source Leakage Current	V _{DS} = 600V, V _{GS} = 0V	-	-	10	uA
		V _{DS} = 480V, T _C = 125 °C	-	-	100	uA
I _{GSS}	Gate-Source Leakage, Forward	V _{GS} = 30V, V _{DS} = 0V	-	-	100	nA
	Gate-source Leakage, Reverse	V _{GS} = -30V, V _{DS} = 0V	-	-	-100	nA
On Characteristics						
V _{GS(th)}	Gate Threshold Voltage	V _{DS} = V _{GS} , I _D = 250uA	2.0	-	4.0	V
R _{DS(on)}	Static Drain-Source On-state Resistance	V _{GS} = 10 V, I _D = 2.0A	-	2.0	2.5	Ω
Dynamic Characteristics						
C _{iss}	Input Capacitance	V _{GS} = 0 V, V _{DS} = 25V, f = 1MHz	-	545	710	pF
C _{oss}	Output Capacitance		-	60	80	
C _{rss}	Reverse Transfer Capacitance		-	8	11	
Dynamic Characteristics						
t _{d(on)}	Turn-on Delay Time	V _{DD} = 300V, I _D = 4.0A, R _G = 25Ω (Note 4, 5)	-	10	30	ns
t _r	Rise Time		-	35	80	
t _{d(off)}	Turn-off Delay Time		-	45	100	
t _f	Fall Time		-	40	90	
Q _g	Total Gate Charge	V _{DS} = 480V, V _{GS} = 10V, I _D = 4.0A (Note 4, 5)	-	15	20	nC
Q _{gs}	Gate-Source Charge		-	2.8	-	
Q _{gd}	Gate-Drain Charge(Miller Charge)		-	6.2	-	

Source-Drain Diode Ratings and Characteristics

Symbol	Parameter	Test Conditions	Min.	Typ.	Max.	Unit.
I _S	Continuous Source Current	Integral Reverse p-n Junction Diode in the MOSFET	-	-	4.0	A
I _{SM}	Pulsed Source Current		-	-	16	
V _{SD}	Diode Forward Voltage	I _S = 4.0A, V _{GS} = 0V	-	-	1.4	V
t _{rr}	Reverse Recovery Time	I _S = 4.0A, V _{GS} = 0V, di _F /dt = 100A/us	-	300	-	ns
Q _{rr}	Reverse Recovery Charge		-	2.2	-	uC

※ NOTES

1. Repeativity rating : pulse width limited by junction temperature
2. L = 27.5mH, I_{AS} = 4.0A, V_{DD} = 50V, R_G = 25Ω, Starting T_J = 25°C
3. I_{SD} ≤ 4.0A, di/dt ≤ 200A/us, V_{DD} ≤ BV_{DSS}, Starting T_J = 25°C
4. Pulse Test : Pulse Width ≤ 300us, Duty Cycle ≤ 2%
5. Essentially independent of operating temperature.

Typical Characteristics

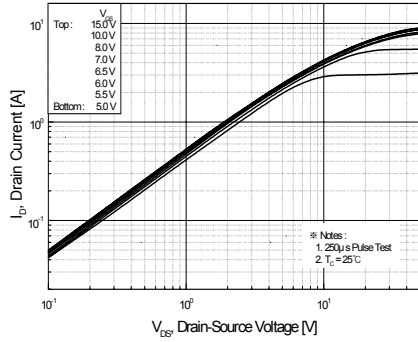

Figure 1. On-Region Characteristics

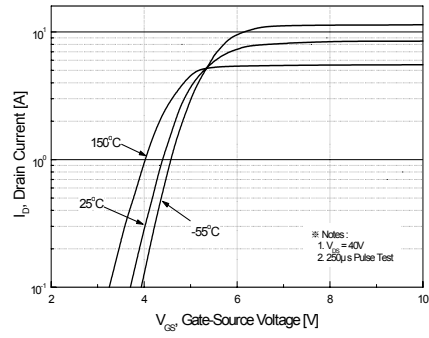

Figure 2. Transfer Characteristics

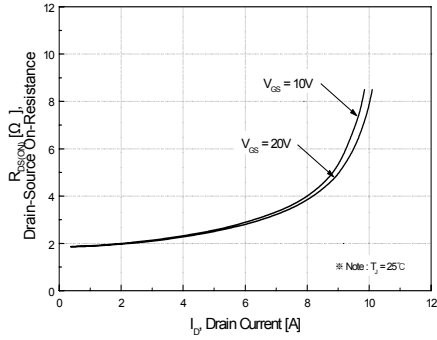

Figure 3. On-Resistance Variation vs Drain Current and Gate Voltage

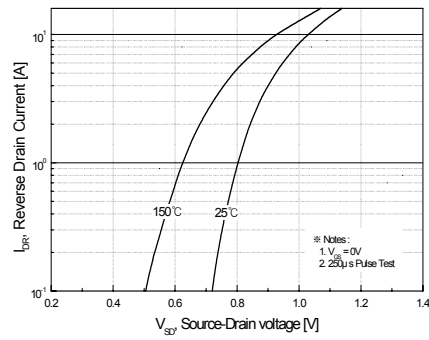

Figure 4. Body Diode Forward Voltage Variation with Source Current and Temperature

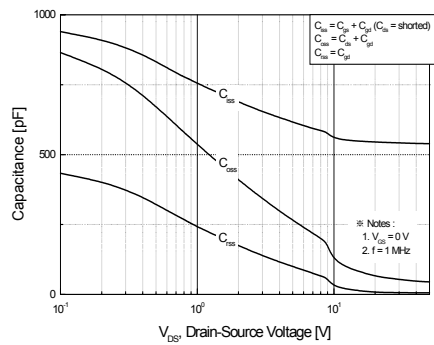

Figure 5. Capacitance Characteristics

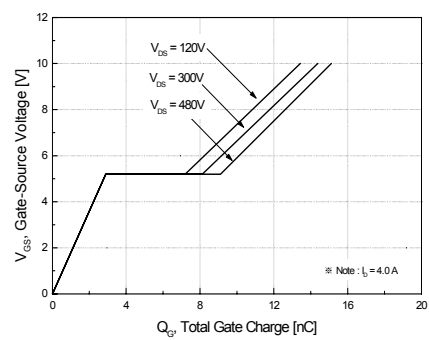

Figure 6. Gate Charge Characteristics

Typical Characteristics (Continued)

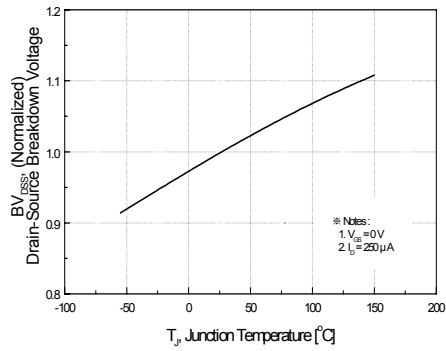

Figure 7. Breakdown Voltage Variation vs Temperature

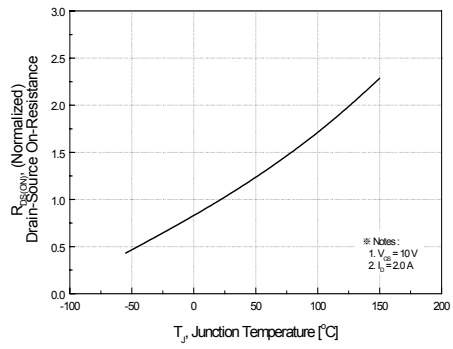

Figure 8. On-Resistance Variation vs Temperature

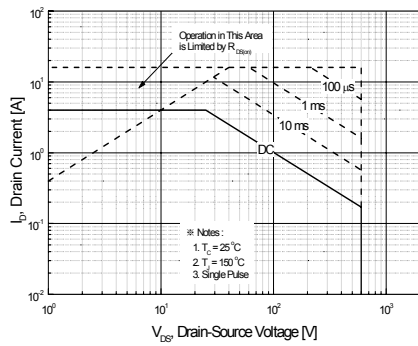

Figure 9. Maximum Safe Operating Area

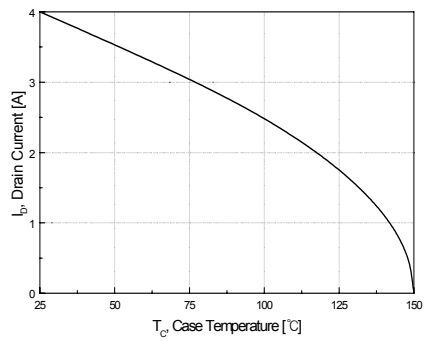

Figure 10. Maximum Drain Current vs Case Temperature

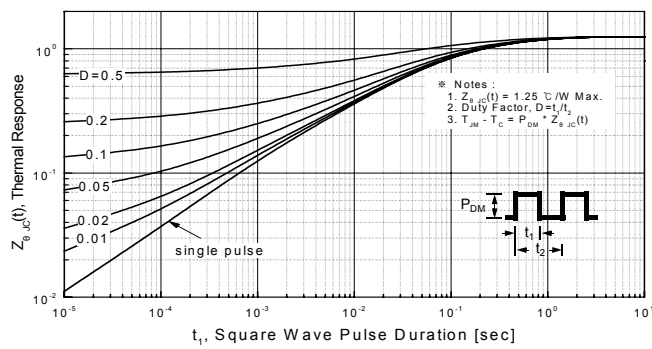
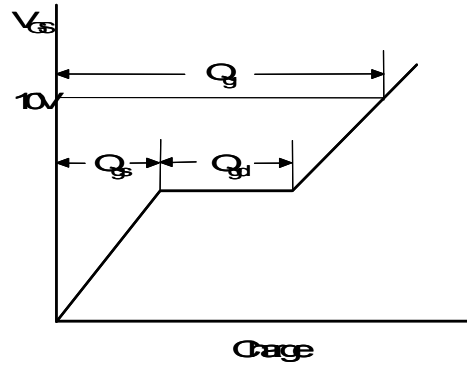
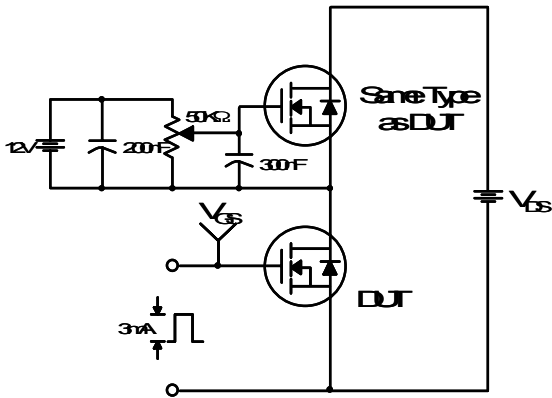
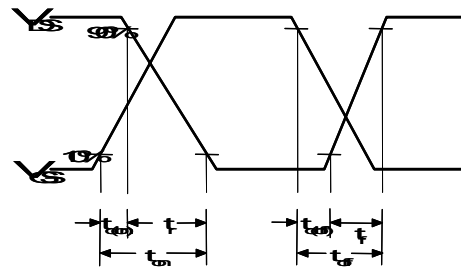
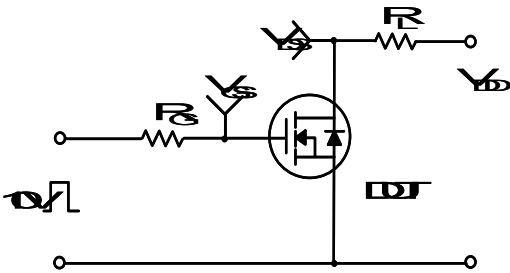

Figure 11. Transient Thermal Response Curve

Gate Charge Test Circuit & Waveform



Resistive Switching Test Circuit & Waveforms



Unclamped Inductive Switching Test Circuit & Waveforms

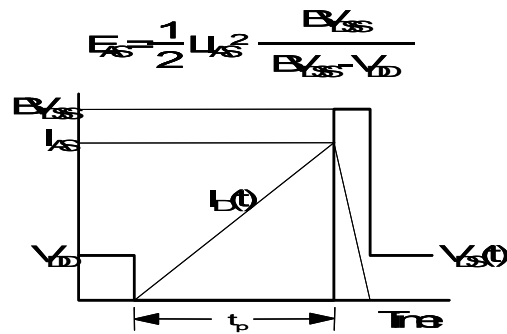
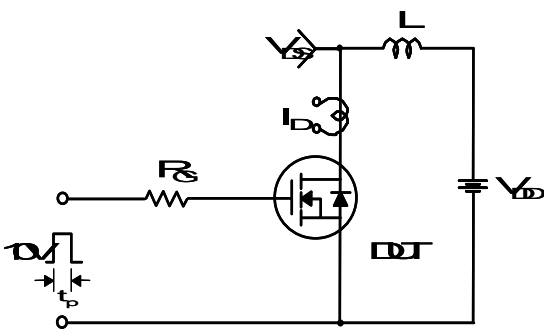

Peak Diode Recovery dv/dt Test Circuit & Waveforms

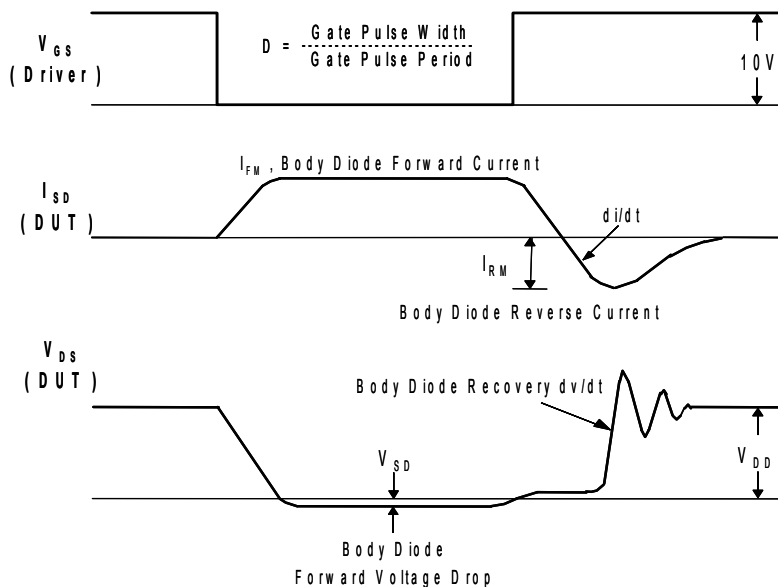
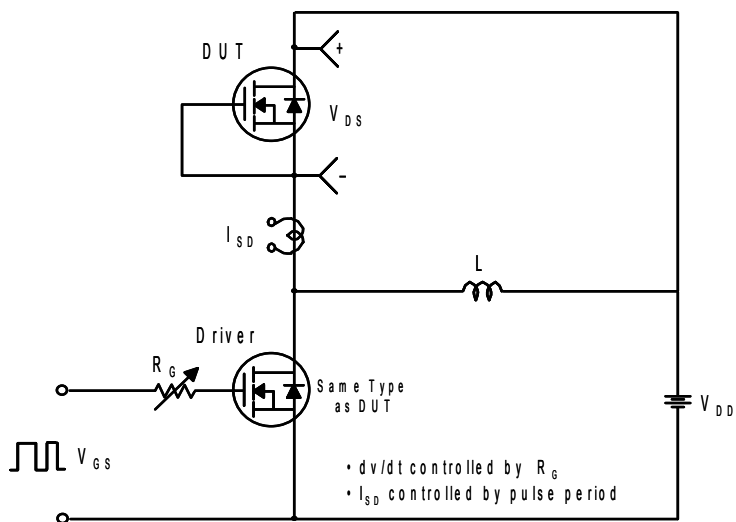

Package Dimensions

TO-220F

