

Preliminary Datasheet

VSC7216-01

Multi-Gigabit Interconnect Chip

Features

- 4 ANSI X3T11 Fibre Channel and IEEE 802.3z Gigabit Ethernet Compliant Transceivers
- Over 8 Gb/s Duplex Raw Data Rate
- Redundant PECL Tx Outputs and Rx Inputs
- 8B/10B Encoder/Decoder per Channel, Optional Encoder/Decoder Bypass Operation
- “ASIC-Friendly™” Timing Options for Transmitter Parallel Input Data
- Elastic Buffers for Intra/Inter-Chip Cable Deskewing and Channel-to-Channel Alignment
- Tx/Rx Rate Matching via IDLE Insertion/Deletion
- Compatible with VSC7211/7212/7214
- Received Data Aligned to Local REFCLK or to Recovered Clock
- PECL Rx Signal Detect and Cable Equalization
- Per-Channel Serial Tx-to-Rx and Parallel Rx-to-Tx Internal Loopback Modes
- Clock Multiplier Generates Baud Rate Clock
- Automatic Lock-to-Reference
- JTAG Boundary Scan Support for TTL I/O
- Built-In Self Test
- 3.3V Supply, 3.0W
- 256-Pin, 27mm BGA package

VSC7216-01 Block Diagram

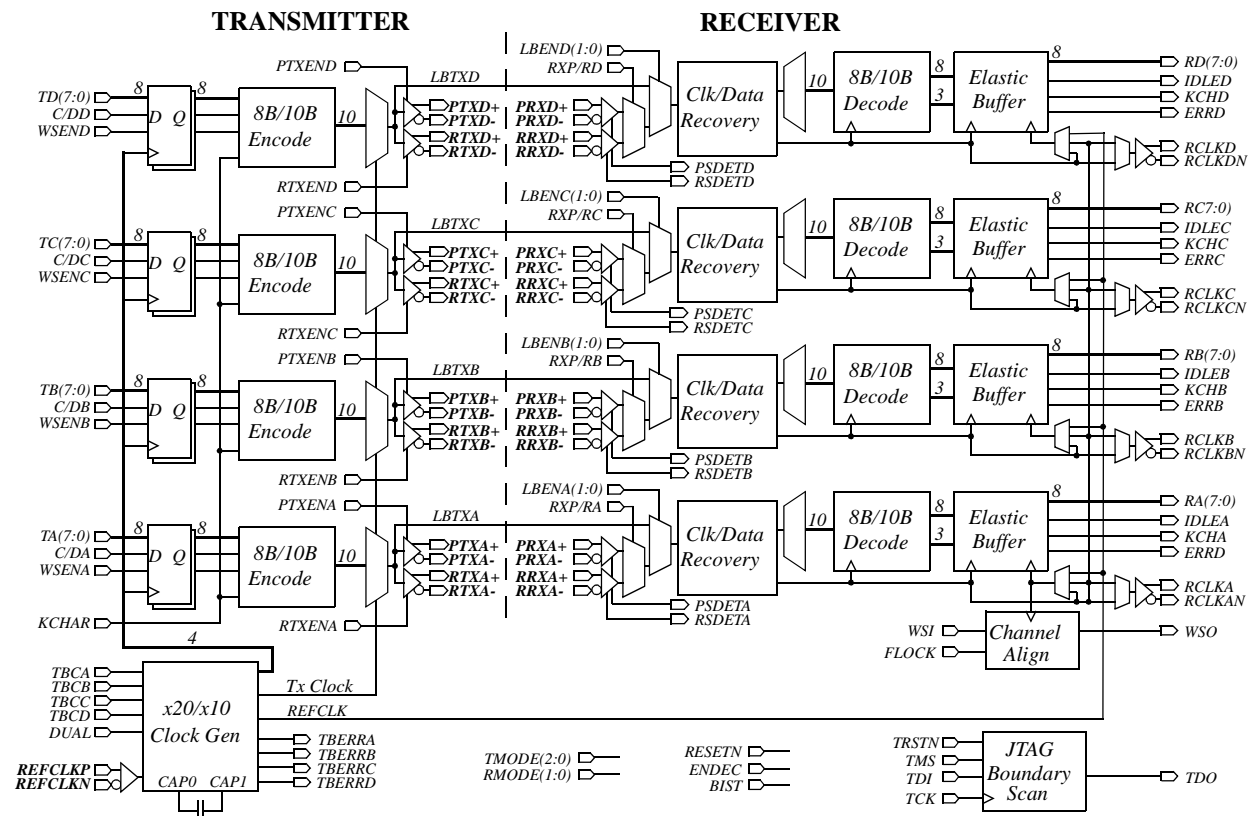

General Description

The VSC7216-01 is a quad, 8-bit parallel-to-serial and serial-to-parallel transceiver chip used for high bandwidth interconnection between busses, backplanes, or other subsystems. Four Fibre Channel and Gigabit Ethernet compliant transceivers provide up to 8.32Gb/s of duplex raw data transfer. Each channel can be operated at a maximum data transfer rate of 1088Mb/s (8 bits at 136MHz) or a minimum rate of 392Mb/s (8 bits at 49MHz). For the entire chip in duplex mode, the aggregate transfer rate is between 6.3Gb/s and 8.7Gb/s. The VSC7216-01 contains four 8B/10B encoders, serializers, de-serializers, 8B/10B decoders and elastic buffers which provide the user with a simple interface for transferring data serially and recovering it on the receive side. The device can also be configured to operate as four non-encoded 10-bit transceivers.

Notation

In this document, each of the four channels are identified as channel A, B, C or D. When discussing a signal on any specific channel, the signal will have the channel letter embedded in the name, e.g., TA(7:0). When referring to the common behavior of a signal which is used on each of the four channels, a lower case "n" is used in the signal name, e.g., Tn(7:0). Differential signals (e.g., PTXA+ and PTXA-) may be referred to as a single signal, i.e. PTXA, by dropping reference to the "+" and "-". REFCLK refers either to the PECL/TTL input pair REFCLKP/REFCLKN, which can be differential PECL (using both REFCLKP and REFCLKN) or single-ended TTL (using REFCLKP and leaving REFCLKN open).

Clock Synthesizer

Depending on the state of the DUAL input, the VSC7216-01 clock synthesizer multiplies the reference frequency provided on the REFCLK input by 10 (DUAL is LOW) or 20 (DUAL is HIGH) to achieve a baud rate clock between 0.98GHz and 1.36GHz. The on-chip PLL uses a single external 0.1µF capacitor, connected between CAP0 and CAP1, to control the Loop Filter. This capacitor should be a multilayer ceramic dielectric, or better, with at least a 5V working voltage rating and a good temperature coefficient (NPO is preferred but X7R may be acceptable). These capacitors are used to minimize the impact of common-mode noise on the Clock Multiplier Unit, especially power supply noise. Higher value capacitors provide better robustness in systems. NPO is preferred because if an X7R capacitor is used, the power supply noise sensitivity will vary with temperature. For best noise immunity, the designer may use a three capacitor circuit with one differential capacitor between CAP0 and CAP1, C1, a capacitor from CAP0 to ground, C2, and a capacitor from CAP1 to ground, C3. Larger values are better but 0.1µF is adequate. However, if the designer cannot use a three capacitor circuit, a single differential capacitor, C1, is adequate. These components should be isolated from noisy traces.

Figure 1: Loop Filter Capacitors (best circuit)

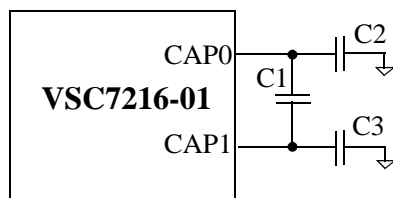

C1=C2=C3= >0.1µF
MultiLayer Ceramic
Surface Mount
NPO (Preferred) or X7R
5V Working Voltage Rating

Preliminary Datasheet

VSC7216-01

Multi-Gigabit Interconnect Chip

The REFCLK signal can be either single-ended TTL or differential LVPECL. If TTL, connect the TTL input to REFCLKP but leave REFCLKN open. If LVPECL, connect the inputs to REFCLKP and REFCLKN. Internal biasing resistors sets the proper DC level to $V_{DD}/2$.

Serial and parallel data rates for all channels may be halved by means of the RATE pin. When RATE is HIGH, the chip is in full-speed mode (default mode of operation) and when LOW, the half-speed mode is selected. Table 1 shows the interaction of the DUAL and RATE inputs.

Table 1: Using the RATE input to Achieve Half-Speed Operation

| <i>RATE Pin</i> | <i>DUAL Pin</i> | <i>Clock Multiplication Factor</i> | <i>Serial Link Speed</i> | <i>Parallel Data Rate</i> | <i>REFCLK Frequency</i> |
|-----------------|-----------------|------------------------------------|--------------------------|---------------------------|-------------------------|
| 0 | 0 | x10 | 500Mb/s | 50Mb/s | 50MHz |
| 0 | 1 | x20 | 500Mb/s | 50Mb/s | 25MHz |
| 1 | 0 | x10 | 1Gb/s | 100Mb/s | 100MHz |
| 1 | 1 | x20 | 1Gb/s | 100Mb/s | 50MHz |

Transmitter Functional Description

Transmitter Data Bus

Each VSC7216-01 transmit channel has an 8-bit input transmit data character, $T_n(7:0)$, and two control inputs, C/Dn and WSENn. The C/Dn input determines whether a normal data character or a special “K-character” is transmitted, and the WSENn input initiates transmission of a 16-character “Word Sync Sequence” used to align the receive channels. These data and control inputs are clocked either on the rising edge of REFCLK, on the rising edge of TBCn, or within the data eye formed by TBCn. When not using REFCLK, each channel uses either its own TBCn input, or uses the TBCA input. The transmit interface mode is controlled by TMODE(2:0) as shown in Table 2.

Table 2: Transmit Interface Input Timing Mode

| <i>TMODE(2:0)</i> | <i>Input Timing Reference</i> |
|-------------------------|-------------------------------|
| 0 0 0 | REFCLK Rising Edge |
| 0 0 1 0 1 0 0 1 1 | Reserved |
| 1 0 0 | TBCA Rising Edge |
| 1 0 1 | TBCn Rising Edge |
| 1 1 0 | TBCA Data Eye |
| 1 1 1 | TBCn Data Eye |

When used, the TBCn inputs must be frequency-locked to REFCLK. No phase relationship is assumed. A small skew buffer is provided to tolerate phase drift between TBCn and REFCLK. This buffer is recentered by the RESETN input, and the total phase drift after recentering must be limited to $\pm 180^\circ$ (where 360° is one character time). Each channel has an error output, TBERRn, that is asserted HIGH to indicate that the phase drift between TBCn and REFCLK has accumulated to the point that the elastic limit of the skew buffer has been exceeded and a transmit data character has been either dropped or duplicated. This error can not occur when input timing is referenced to REFCLK. The TBERRn output timing is identical to the low-speed receiver outputs, as selected by RMODE(1:0) in Table 6.

Figures 2 through 4 show the possible relationships between data and control inputs and the selected input timing source. Figure 2 shows how REFCLK is used as an input timing reference. This mode of operation is used in the VSC7211 and VSC7214. Figure 3 and Figure 4 show how TBCn is used as an input timing reference. When TBCn is used to define a data eye as shown in Figure 4, it functions as an additional data input that simply toggles every cycle.

Note that the REFCLK and TBCn inputs are not used directly to clock the input data. Instead, an internal Phase-Lock Loop (PLL) generates edges aligned with the appropriate clock. The arrows on the rising edges of these signals define the reference edge for the internal phase detection logic. An internal clock is generated at one-tenth the serial transmit data rate that is locked to the selected input timing source. This is an especially important issue when DUAL is HIGH and input timing is referenced to REFCLK, since the falling edge is NOT used. The internal clock active edges are placed coincident with the REFCLK rising edges and halfway between the REFCLK rising edges in this mode.

A similar situation exists when TBCn is used to define a data eye, only the rising edges of TBCn are used to define the external data timing. The internal clock active edges are placed at 90° and 270° points between consecutive TBCn rising edges (which are assumed to be 360° apart).

Figure 2: Transmit Timing, TMODE(2:0) = 000

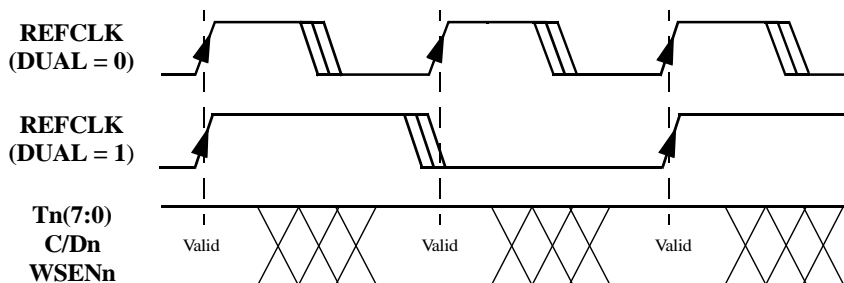
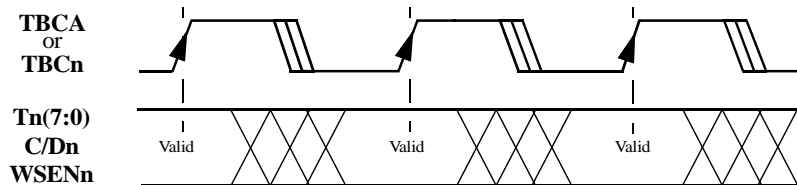

Figure 3: Transmit Timing, TMODE(2:0) = 10X



Preliminary Datasheet

VSC7216-01

Multi-Gigabit Interconnect Chip

Figure 4: Transmit Timing, $TMODE(2:0) = 11X$ ("ASIC-Friendly" Timing)

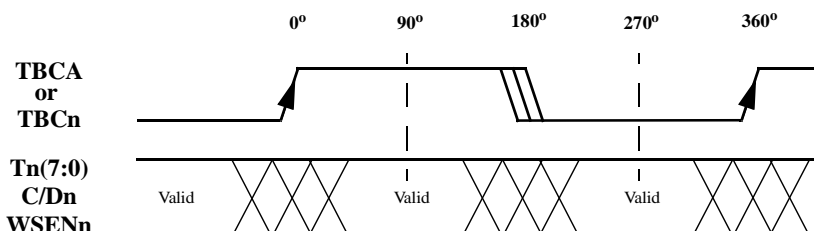

8B/10B Encoder

Each channel contains an 8B/10B encoder which translates the 8-bit input data on $Tn(7:0)$ into a 10-bit encoded data character. C/Dn inputs are also provided in each channel which, along with $KCHAR$, allow the transmission of special Fibre Channel $Kxx.x$ characters (see Table 3). Note that $KCHAR$ is a static input, and does NOT have the same input timing as $Tn(7:0)$, C/Dn and $WSENn$. Normally C/Dn is LOW in order to transmit data. If C/Dn is HIGH and $KCHAR$ is LOW, then a Fibre Channel defined IDLE Character ($K28.5 = '0011111010'$ or $'1100000101'$ depending on disparity) is transmitted and $Tn(7:0)$ is ignored. If C/Dn is HIGH and $KCHAR$ is HIGH, a $Kxx.x$ character is transmitted as determined by the data pattern on $Tn(7:0)$ (see Table 4). Data patterns other than those defined in Table 4 produce undefined 10B encodings.

Table 3: Transmit Data Controls

| $WSENn$ | C/Dn | $KCHAR$ | Encoded 10-Bit Output |
|---------|--------|---------|---------------------------------|
| 0 | 0 | X | Data Character |
| 0 | 1 | 0 | IDLE Character (K28.5) |
| 0 | 1 | 1 | Special $Kxx.x$ Character |
| 1 | X | X | 16-Character Word Sync Sequence |

Table 4: Special Characters (Selected when C/Dn and $KCHAR$ are HIGH)

| Code | $Tn(7:0)$ | Comment | Code | $Tn(7:0)$ | Comment |
|--------|-----------|--------------|--------|-----------|--------------|
| K28.0 | 000 11100 | User Defined | K28.5- | 101 01101 | User Defined |
| K28.1 | 001 11100 | User Defined | K28.6 | 110 11100 | User Defined |
| K28.2 | 010 11100 | User Defined | K28.7 | 111 11100 | Test Only |
| K28.3 | 011 11100 | User Defined | K23.7 | 111 10111 | User Defined |
| K28.4 | 100 11100 | User Defined | K27.7 | 111 11011 | User Defined |
| K28.5 | 101 11100 | IDLE | K29.7 | 111 11101 | User Defined |
| K28.5+ | 101 01100 | User Defined | K30.7 | 111 11110 | User Defined |

Encoder Bypass Mode

When ENDEC is LOW, the 8B/10B encoders are bypassed and a 10-bit input character $T_n(7:0)$ is serialized directly in each channel, bit T_n0 is transmitted first. The C/D_n input becomes T_n8 , and $WSEN_n$ becomes T_n9 . The $KCHAR$ input becomes $ENCDET$ which is not used in the transmitter, but when HIGH, enables Comma detection in all four receivers. Refer to the *Decoder Bypass Mode* section for a description of this mode of operation in the receiver. The latency through the transmitter is reduced by one character time when ENDEC is LOW. This mode of operation is similar to a 10-bit interface commonly found in serializer/deserializers for the Fibre Channel (VSC7125) and Gigabit Ethernet markets (VSC7135).

Word Sync Generation

The VSC7216-01 can perform channel alignment (also referred to as “word alignment” or “word sync”), meaning that the four receive data output streams are aligned such that the same 4-byte word presented to the four transmit channel inputs for serialization will be transferred on the receive channel parallel outputs. The Word Sync Sequence provides a unique synchronization point in the serial data stream that is used to align the receive channels. This sequence consists of 16 consecutive K28.5 IDLE characters with disparity reversals on the second and fourth characters. The Word Sync Sequence is sent either as “I+ I+ I- I- I+ I- I+ I- I+ I- I+ I- I+ I- I+ I-” or as “I- I- I+ I+ I- I+ I- I+ I- I+ I- I+ I- I+ I- I+”, depending on the transmitter’s running disparity at the time the first IDLE character is serialized.

Transmission of the Word Sync Sequence is initiated independently in each channel when the $WSEN_n$ input is asserted HIGH for one character time (see Figure 5). When $WSEN_n$ is HIGH, the C/D_n and $T_n(7:0)$ inputs are ignored. The $WSEN_n$, C/D_n and $T_n(7:0)$ inputs are also ignored for the subsequent 15 character times. In Figure 5, the Word Sync Sequence is initiated in cycle $W1$ and transmitted through cycle $W16$. Normal data transmission (or the transmission of another Word Sync Sequence) resumes in cycle $D3$. This figure is illustrated assuming that input timing is referenced to REFCLK (e.g., $TMODE(2:0)=000$) with the DUAL input LOW. As long as $WSEN_n$ remains asserted, another Word Sync Sequence will be generated.

Figure 5: Word Sync Sequence Generation

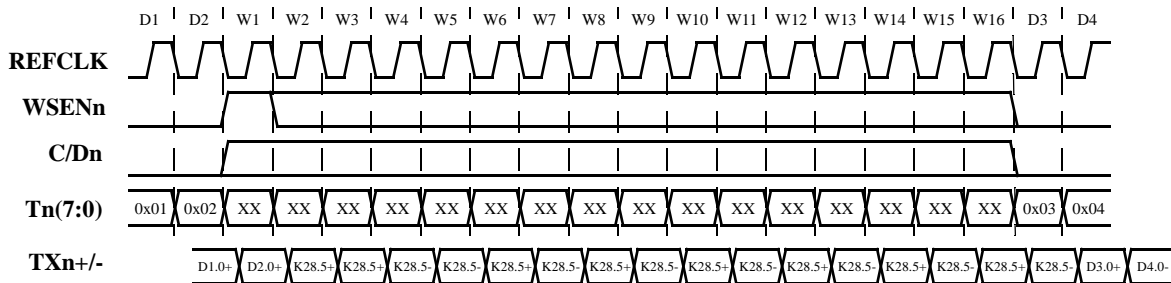

Preliminary Datasheet

VSC7216-01

Multi-Gigabit Interconnect Chip

Serializer

The 10-bit output from the encoder (or from the encoder input register if ENDEC is LOW) is fed into a multiplexer which serializes the parallel data using the synthesized transmit clock. The least significant bit of the 10B data is transmitted first. Each channel has both primary and redundant serial output ports, PTXn and RTXn respectively, which consist of differential PECL output buffers operating at either 10 or 20 times the REFCLK rate. The primary and redundant transmitter outputs are separately controllable on each channel. The primary PECL outputs PTXn are enabled when the PTXENn input is HIGH, and the redundant PECL outputs RTXn are enabled when the RTXENn input is HIGH. When a PECL output is disabled, the associated output buffers do not consume power and the attached pins are un-driven. The PECL outputs do not require external resistors.

Receiver Functional Description

Serial Data Source

Each receive channel has both primary and redundant serial input ports, PRXn and RRXn, respectively, which consist of differential PECL input buffers. Each channel also has a control input, RXP/Rn, used to select either the primary or redundant serial input as the data source for that channel. When RXP/RC is HIGH, the C channel serial data source is PRXC. When LBENn(1:0)=10, the channel's transmitter is looped back and becomes the serial data source regardless of the state of RXP/Rn (see Table 5).

Table 5: Serial Data Source Selection

| <i>LBENn(1:0)</i> | <i>RXP/Rn</i> | <i>Serial Data Source</i> |
|-------------------|---------------|-------------------------------------|
| ≠ 10 | 0 | RRXn |
| ≠ 10 | 1 | PRXn |
| = 10 | X | LBTXn Loopback from Transmitters |

Signal Detection

Each channel's primary and redundant PECL input buffers have an associated signal detect output, PSDEtn and RSEDEtn. All eight outputs are available for continuous monitoring of both the selected and non-selected input. Each signal detect output is asserted HIGH when transitions are detected on the associated PECL input and the signal amplitude exceeds 200mV under nominal operating conditions. A LOW indicates that either no transitions are detected or the signal amplitude is below 100mV under nominal operating conditions. The signal detect outputs are considered undefined when the signal amplitude is in the 100mV to 200mV range. The signal detect circuitry behaves like a re-triggerable one-shot that is triggered by signal transitions, and whose time-out interval ranges from 40 to 80 bit times. The transition density is not checked to make sure that it

corresponds to a valid Fibre Channel data stream. The PSDET_n and RSDET_n output timing is identical to the low-speed receiver outputs, as selected by RMODE(1:0). See Table 6.

Receiver Equalization

Incoming data on the PRX/RRX inputs typically contains a substantial amount of Inter Symbol Interference (ISI) or deterministic jitter which reduces the ability of the receiver to recover data without errors. An equalizer has been added to each of the receiver's input buffers in order to compensate for this deterministic jitter. This circuit has been designed to effectively reduce the ISI commonly found in copper cables or backplane traces due to low frequencies traveling faster than high frequencies as a result of the skin effect. The equalizer boosts high frequency edge response in order to reduce the adverse effects of ISI.

Clock and Data Recovery

At the receiver, each channel contains an independent Clock Recovery Unit (CRU) which accepts the selected serial input source, extracts the high-speed clock and retimes the data. Each CRU automatically locks on data and if the data is not present, will automatically lock to the REFCLK. This maintains a very well-behaved recovered clock, RCLK_n/RCLK_{Nn} which does not contain any slivers and will operate at a frequency of the REFCLK reference ± 200 ppm. The use of an external Lock-to-Reference pin is not needed.

The Clock Recovery Unit must perform bit synchronization which occurs when the CRU locks onto and properly samples the incoming serial data as described in the previous paragraph. When the CRU is not locked onto the serial data, the 10-bit data out of the decoder is invalid which results in numerous 8B/10B decoding errors or disparity errors. When the link is disturbed (e.g., the cable is disconnected or the serial data source is switched), the CRU will require a certain amount of time to lock onto data which is specified in the AC Timing Characteristics for "Data Acquisition Lock Time."

Deserializer and Character Alignment

The retimed serial data stream is converted into 10-bit characters by the deserializer. A special 7-bit "Comma" pattern ('001111xxx' or '1100000xxx') is recognized by the receiver and allows it to identify the 10-bit character boundary. Note that this pattern is found in three special characters, K28.1, K28.5 and K28.7, however, K28.5 is chosen as the unique IDLE character. Only K28.1 and K28.5 should be used in normal operation. The K28.7 character should be reserved for test and characterization use.

Character alignment occurs when the deserializer synchronizes the 10-bit character framing boundary to a "Comma" pattern in the incoming serial data stream. If the receiver identifies a "Comma" pattern in the incoming data stream which is misaligned to the current framing boundary the receiver will re-synchronize the recovered data in order to align the data to the new "Comma" pattern. Re-synchronization ensures that the "Comma" character is output on the internal 10-bit bus so that bits 0 through 9 equal '001111xxx' or '1100000xxx'. If the "Comma" pattern is aligned with the current framing boundary, re-synchronization will not change the current alignment. Re-synchronization is always enabled and cannot be turned off when ENDEC is HIGH. After character re-synchronization the VSC7216-01 ensures that within a link, the 8-bit data sent to the transmitting VSC7216-01 will be recovered by the receiving VSC7216-01 in the same bit locations as the transmitter (i.e., T_n(7:0) = R_n(7:0)). When ENDEC is LOW, "Comma" detection and alignment are enabled only if KCHAR is HIGH.

Preliminary Datasheet

VSC7216-01

Multi-Gigabit Interconnect Chip

10B/8B Decoder

The 10-bit character from the deserializer is decoded in the 10B/8B decoder, which outputs the 8B data byte and three bits of status information. If the 10-bit character does not match any valid value, an Out-of-Band Error is generated which is output on the receiver status bus. Similarly, if the running disparity of the character does not match the expected value, a Disparity Error is generated. The decoder also reports when a K-character is received, and distinguishes the K28.5 (IDLE) character from other K-characters. This status information is combined with LOS State Machine status and FIFO error status, to produce the prioritized per-character link status output information (see Table 8).

Elastic Buffer and Channel De-Skewing

An elastic buffer is included in each of the four receive channels. Decoded data and status information is written into these buffers on each channel's recovered clock, and is read on the selected output clock. In addition to allowing decoded data to easily cross from a channel's recovered clock domain to its output clock domain, the elastic buffers facilitate channel alignment (the reconstruction of a multi-byte word as presented to the transmitting devices), and they facilitate rate matching via IDLE character insertion/deletion when the channel's recovered clock is not frequency-locked to its output clock.

There are three conditions under which a receive channel's elastic buffer is recentered: the RESETN input, when asserted, recenters the read/write pointers in each elasticity buffer; whenever a "Comma" character is received which changes the receive character's framing boundary, the elasticity buffer is recentered; and lastly, it is also recentered whenever the receiver detects the synchronization point in the Word Sync Sequence. All three of these events are associated with chip initialization or link initialization and would not occur during normal data transfer. Note that recentering can result in the loss or duplication of decoded character data and status information.

When a condition change transmit timing (e.g., phase shifts in TBC) or shifts phase/alignment into the receiver, the user should initial a Word Sync Event to recenter all elasticity buffers. Otherwise, data corruption could occur.

The VSC7216-01 presents recovered data on Rn(7:0) and status on IDLEn, KCHn and ERRn. These outputs are timed either to each channel's own recovered clock (RCLKn/RCLKNn), to Channel A's recovered clock (RCLKA/RCLKNA), or to REFCLK. The output timing reference is selected by RMODE(1:0) (see Table 6). The transmitter input skew buffer error outputs TBERRn and the analog signal detect outputs PSDETn and RSDETn are also synchronized to the selected output timing reference. There are two choices for REFCLK-based timing, which differ in the positioning of the data valid window associated with the output signals timed to REFCLK: when RMODE(1:0)=00 REFCLK is approximately centered in the output data valid window as in the VSC7214 and when RMODE(1:0)=01 REFCLK slightly leads the data valid window so that output data appears to have a more typical "Clock-to-Q" timing relationship to REFCLK.

Table 6: Receive Interface Output Timing Mode

| <i>RMODE(1:0)</i> | <i>Output Timing Reference</i> |
|-------------------|--------------------------------|
| 0 0 | REFCLK (centered) |
| 0 1 | REFCLK (leading) |
| 1 0 | RCLKA/RCLKNA |
| 1 1 | RCLKn/RCLKNn |

The term “word clock” will be used for whichever clock, REFCLK, RCLKA/RCLKNA or RCLKn/RCLKNn, is selected as the output timing reference. If RMODE(1) is HIGH, each channels’ RCLKn/RCLKNn outputs are complementary outputs at 1/10th or 1/20th the baud rate of the incoming data depending upon DUAL. When RCLKA/RCLKNA is selected as the output timing reference, the Channel B, C and D RCLKn/RCLKNn outputs are copies of RCLKA/RCLKNA. If RMODE(1) is LOW, then each channels’ RCLKn/RCLKNn outputs are held in a LOW/HIGH state, respectively, and the data and status outputs are timed to REFCLK. If DUAL is HIGH, all data at the four output ports are synchronously clocked out on both positive and negative edges of the selected word clock at 1/20th the baud rate. If DUAL is LOW, the data is clocked out of the VSC7216-01 only on the rising edge of the selected word clock at 1/10th the baud rate. Timing waveforms for the output data and status are shown in Figure 6, Figure 7 and Figure 8.

Figure 6: Receive Timing, RMODE(1:0) = 00

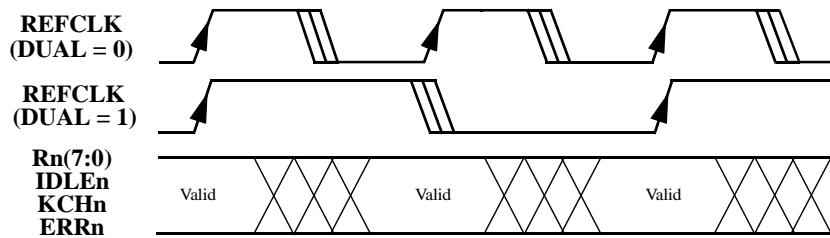

Figure 7: Receive Timing, RMODE(1:0) = 01

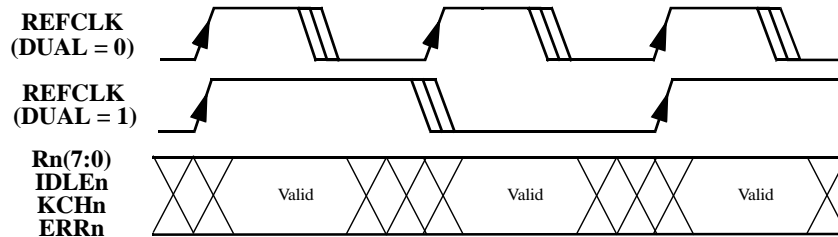
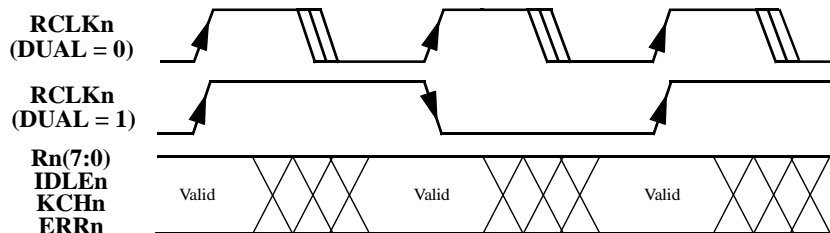

Figure 8: Receive Timing, RMODE(1:0) = 1X



Preliminary Datasheet

VSC7216-01

Multi-Gigabit Interconnect Chip

The data coming from the decoder is clocked into the elastic buffer by the recovered clock from the channel's CRU. The data is clocked out of the elastic buffers with word clock. If the transmitting device's REFCLK is not precisely frequency-locked to a receive channel's word clock, the channel's elastic buffer will tend to gradually fill or empty as the recovered clock (which is by definition frequency-locked to the transmitter's REFCLK) steadily drifts in phase relative to the word clock.

In order to accommodate frequency differences between a transmitter's REFCLK and the word clock, the VSC7216-01 can automatically perform rate matching by either deleting or duplicating IDLE characters. The FLOCK input must be LOW to enable rate matching which, based on how the WSI input is connected, can either be performed in each channel individually or can be performed in parallel across a group of channels that are word-aligned. This is discussed in detail in the *Word Alignment* section below. It is the user's responsibility to ensure that the frequency at which IDLEs are simultaneously transmitted on each channel accommodates the frequency differences, if any, in their system architecture. Not meeting the IDLE density requirements could result in Underrun/Overrun Errors. However, the use of a continuous stream of IDLE characters should be avoided when rate matching is enable. The IDLE addition/deletion logic relies on the status bits (see Table 8 for details) to identify K28.5 IDLE characters. The use of continuous IDLE characters will force the VSC7216-01 into the RESYNC state (see Figure 9) resulting in a status bit sequence which the addition/deletion logic does not recognize as an IDLE character.

The elastic buffer is designed to allow a maximum phase drift of +2 or -2 serial clock bit times between re-synchronizations, which sets a limit on the maximum data "packet" length allowed between IDLEs. This maximum packet length depends on the frequency difference between the transmitting and receiving device's REFCLKs. Let $\Delta\phi$ represent phase drift in bit times, and let 2π represent one full 10-bit character of phase drift. Limiting phase drift to two bit times means the following inequality must be satisfied:

$$(1) \quad \Delta\phi \leq (0.2 \times 2\pi)$$

Let L be the number of 10-bit characters transmitted, and let Δf be the frequency offset in ppm. The total phase drift in bit times is given by:

$$(2) \quad \Delta\phi = (\Delta f / 10^6) \times 2\pi L$$

A simple expression for maximum packet length as a function of frequency offset is derived by substituting (2) in (1) and solving for L :

$$(3) \quad L \leq (0.2 \times 10^6) / \Delta f$$

As an example, if the frequency offset is 200ppm, the maximum packet length should not be more than 1K bytes. To increase the maximum packet length L , decrease the frequency offset Δf . Please note that if only one K28.5 is transmitted between "packets" of data, it might be dropped during compensation for phase drift. If the user must have at least one K28.5 between these two packets, then two K28.5s must be transmitted.

Word Alignment

The VSC7216-01 performs channel-to-channel word alignment. In this mode of operation, if the data from all four channels on the transmitting VSC7216-01 (e.g., the 4 Tn(7:0) busses) is viewed as a 32-bit word, then the receiving VSC7216-01 will recover an identical word. For example, if a transmit pattern was 'ABCD',

‘EFGH’, ‘IJKL’, etc., the receiver should not recover data words as ‘ABGD’, ‘EFKH’, ‘IJOL’, etc. This requires the four transmit channels to obtain input data on a common clock (e.g., TMODE(2:0)=000 or 1X0) and the four receive channels to present output data on a common word clock (e.g., RMODE(1:0)=0X or 10).

Within the receiver there are elastic buffers used to deskew the four channels and align them to a common word clock. An elastic buffer allows the channels’ input to be skewed up to ± 6 bit times (12 bit times total skew between any two channels) in order to accommodate circuit imperfections, differences in transmission delay and jitter. Multiple VSC7216-01 devices can also be used in synchronous operation if the skew between all serial input pairs is maintained less than ± 6 serial clock bit times. This allows easy implementation of robust systems, and is discussed in greater detail in the *Using Multiple VSC7216-01s in Parallel* section.

In order to perform word alignment, a synchronization point must be seen across all aligned receive channels within the ± 6 bit time window. The VSC7216-01 receiver recognizes the first four characters of the Word Sync Sequence (either K28.5+ K28.5+ K28.5- K28.5- or K28.5- K28.5- K28.5+ K28.5+) as the synchronization point. As a model for understanding, consider the case where a VSC7216-01 transmitter sends 32 bits of data to the receiver via copper media which has small cable length differences causing a channel-to-channel skew. All transmit channels that are to be word aligned transmit the Word Sync Sequence in parallel. On detection of the synchronization point, the receivers will reposition the recovered data within their elastic buffers in order to align all four channels and remove any channel-to-channel skew. All normal data characters following the Word Sync Sequence will be properly word aligned. In the process of channel alignment, one or two of the final twelve K28.5 characters in the Word Sync Sequence may be deleted or duplicated. This ensures that each transmitted 32-bit word is recovered correctly.

The VSC7216-01 is capable of performing rate matching in word-aligned applications by inserting or deleting IDLEs in parallel across the aligned receive channels. This requires that the word-aligned data streams contain IDLEs inserted in parallel on all transmit channels (e.g., an IDLE “word”) according to the IDLE density requirement previously described.

Word alignment is enabled by connecting the WSI input to a WSO output, either from the same device if a single device is used, or from another device if multiple devices are used in parallel to align more than four channels. The FLOCK input state and WSI input source determine whether or not rate matching (IDLE deletion or duplication) will be performed, and whether it is done independently on each channel or in parallel across aligned channels. Word alignment is disabled when WSI is not connected to a WSO output. Rate matching is disabled when either FLOCK is HIGH or WSI is held LOW (see Table 7).

Table 7: Word Alignment and Rate Matching Control

| <i>FLOCK</i> | <i>WSI Source</i> | <i>Word Alignment</i> | <i>Rate Matching</i> |
|--------------|-------------------|-----------------------|-------------------------------|
| 0 | 0 | Off | Off |
| 0 | 1 | Off | Enabled, Independent Channels |
| 0 | WSO | Enabled | Enabled, Aligned Channels |
| 1 | 0 | Off | Off |
| 1 | 1 | Off | Off |
| 1 | WSO | Enabled | Off |

Preliminary Datasheet**VSC7216-01***Multi-Gigabit Interconnect Chip*

There are four distinct modes of operation defined in Table 7. The first row disables both word alignment and rate matching. (The fourth and fifth row configurations function identically to the first row.) The second row configures the channels to operate independently with rate matching. Word alignment is disabled, and IDLEs will be dropped/duplicated independently in each channel as required. The third row configures the part to perform word alignment and rate matching. The receive channels will be aligned per the device driving WSO, and IDLE words will be dropped/duplicated across the aligned channels as required. The last row configures the part to perform word alignment and disables rate matching. This mode of operation is appropriate for a frequency-locked application where it desired to align the receive channels without altering the received data streams.

Using Multiple VSC7216-01s in Parallel

Multiple VSC7216-01s can be used in parallel to form wider bus widths. In order for word alignment to function correctly across multiple devices, each transmit channel's input data must be transmitted on a common clock, and each receive channel's output data must also be aligned to a common word clock. This requires that all transmitting devices use either the same or identical REFCLKs, and that TMODE(2:0)=000 (inputs timed to REFCLK) or TMODE(2:0)=1X0 (inputs timed to TBCA). If inputs are timed to TBCA, then all transmitting devices must use either the same or identical TBCAs. Since all receive channels must use a common word clock, the receiving devices must also use the same or identical REFCLKs and it must be selected as the word clock for all receive channels (RMODE(1:0)=0X).

If the transmitting devices' REFCLKs are not frequency-locked to the receiving devices' REFCLKs, IDLEs will have to be added to or dropped from all the channels at the same time. In order to implement this, one VSC7216-01 is arbitrarily chosen as the "Master" and its WSO output is driven to the WSI inputs of all the receiving VSC7216-01s, including itself. WSO is asserted prior to the VSC7216-01 adding/dropping IDLEs so all the VSC7216-01s will operate simultaneously. WSO uses a simple 3-bit serial protocol, synchronous to the Master channel's word clock for indicating the required synchronization action to other VSC7216-01s. A steady LOW level indicates no action is required. '101' indicates that Master Channel A has seen a Word Sync Event. The relative timing relationship between receiving a Word Sync Event (on all channels together) and seeing '101' on the WSI input in the other channels allows these channels to word-synchronize with Master Channel A. '110' indicates that the next IDLE encountered in the receive data stream should be deleted. '111' indicates that an IDLE should be inserted after the next IDLE encountered in the receive data stream. Note that the arbitrarily chosen Master Channel A must be an active channel.

Decoder Bypass Mode

If ENDEC is LOW, the 8B/10B decoder is bypassed and a 10-bit received character Rn(9:0) is output from each receive channel. The KCHn output becomes Rn8, and ERRn becomes Rn9. Character alignment is handled differently in this mode of operation. As mentioned in the "Encoder Bypass Mode" section, the KCHAR input becomes ENCDDET which enables Comma detection and re-synchronization when HIGH, and disables re-synchronization when LOW. Only the '001111xxx' version of the "Comma" pattern is recognized when ENDEC is LOW. The IDLEn output becomes COMDET (Comma Detect) which signals detection of the '001111xxx' Comma pattern in the current 10-bit output character when HIGH. This mode of operation is equivalent to a 10-bit interface commonly found in serializer/deserializers for the Fibre Channel (VSC7125) and Gigabit Ethernet markets (VSC7135).

The logic used to align the four receive channels and/or insert and delete IDLE characters to compensate for REFCLK variations between transmitting and receiving devices is disabled when ENDEC is LOW. In order for this mode of operation to function without errors, the word clock source as selected by RMODE(1:0) must be frequency-locked to the REFCLK of the remote transmitting device in each channel. This is guaranteed when RMODE(1:0) = 11. For other choices of RMODE(1:0), the frequency-locked condition must be guaranteed by system design. When DUAL is HIGH and RMODE(1:0) = 10 or 11, the character containing the '001111xxx' "Comma" pattern is aligned to RCLKn/RCLKNn in each channel so that COMDET will be asserted on the falling edge of RCLKn (rising edge of RCLKNn). This is done by adjusting the latency through the elastic buffer; the recovered clock is never stretched or slivered. When the "Comma" pattern changes the framing boundary, data characters prior to the assertion of COMDET on the falling edge of RCLKn may be corrupted.

Receiver State Machine

Each channel contains a Loss of Synchronization State Machine (LSSM) which is responsible for detecting and handling loss of bit, channel, word and word clock synchronization in a controlled manner. There are three states in the LSSM: LOSS_OF_SYNC, RESYNC, and SYNC_ACQUIRED as shown in the state diagram of Figure 9. The RESYNC state is entered when a 10-bit word has been received which contains the 7-bit Comma pattern (e.g., a K28.5 IDLE character). After entering the RESYNC state, the VSC7216-01 will stay in it until a valid, non-Comma transmission is received, then it transitions to the SYNC_ACQUIRED state indicating a normal operating condition. The RESYNC state is re-entered if four consecutive "Commas" are received or if a single "Comma" is received that changes the 10B character framing boundary. The LOSS_OF_SYNC state is entered whenever four consecutive invalid transmissions have been detected or when the occurrences of invalid transmission outnumber those of valid transmission by four. The relative occurrences of invalid verses valid transmissions are monitored with a simple up/down counter that increments when an invalid transmission is detected and decrements otherwise. The LSSM transitions to the LOSS_OF_SYNC state when the counter reaches four, and the counter is reset. A state diagram for the invalid transmission counter is shown in Figure 10. The VSC7216-01 receiver will stay in the LOSS_OF_SYNC state until a valid "Comma" pattern is detected. Note that the RESYNC state is entered whenever the 10B framing boundary is changed, and whenever the Word Sync Sequence is received. When ENDEC is LOW, the ERRn, KCHn and IDLEn outputs are re-defined and the decoder and associated LSSM logic in each channel is unused.

Preliminary Datasheet
VSC7216-01

Multi-Gigabit Interconnect Chip

Figure 9: State Diagram of the Loss of Synchronization State Machine

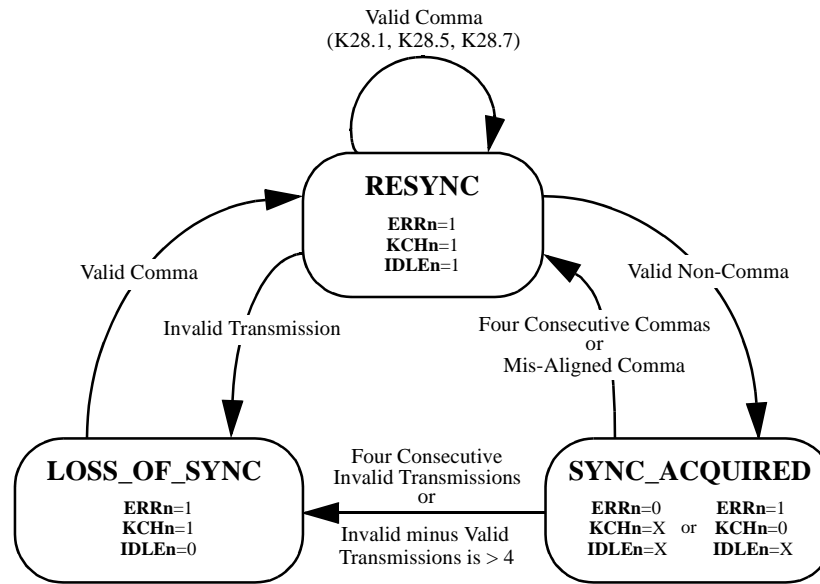
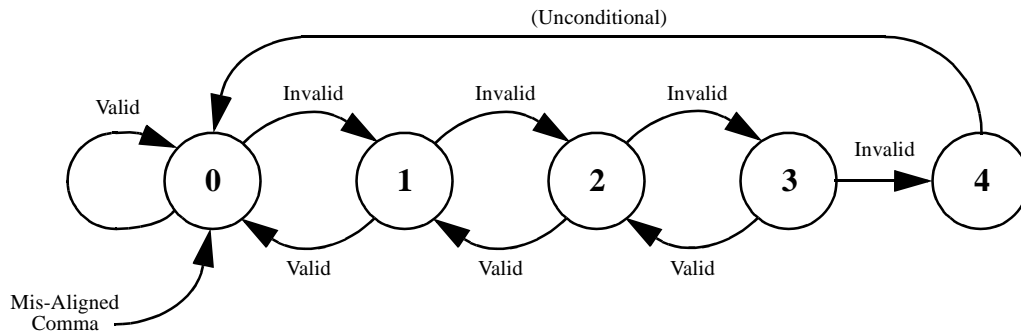

Figure 10: State Diagram of the Invalid Transmission Counter



Link Status Outputs

The receiver ERR_n, KCH_n and IDLE_n outputs indicate status for each channel as shown in Table 8. Since this status is encoded, multiple conditions could occur simultaneously so the states are prioritized as indicated (1 being highest priority). For example, if both Out-of-Band and Disparity Errors occur, only an Out-of-Band Error is reported because it has higher priority.

The ERR_n, KCH_n and IDLE_n status signals apply to the data on R_n(7:0) on a per-character basis. The only exception to this is the Underrun/Overrun indication, which is asserted coincident with the duplicated character when an underrun occurs, and is asserted following the deleted character (i.e., on the cycle where the deleted character should have appeared) when overrun occurs.

Table 8: Receiver Status Signals

| <i>ERR_n</i> | <i>KCH_n</i> | <i>IDLE_n</i> | <i>Priority</i> | <i>Link Status</i> |
|------------------------|------------------------|-------------------------|-----------------|---|
| 0 | 0 | 0 | 7 | Valid Data Transmission: A valid 10B data character with correct disparity was received. The correctly decoded version of this character is on R _n (7:0). |
| 0 | 0 | 1 | 1 | Underrun/Overrun Error: The elastic buffer has not been able to add/drop an IDLE when required. Data on R _n (7:0) is invalid. |
| 0 | 1 | 0 | 6 | Kxx.x Special Character Detected (not IDLE): A valid 10B special character with correct disparity was received. The correctly decoded version of this character, per Table 4, is on R _n (7:0). |
| 0 | 1 | 1 | 5 | IDLE Detected: A valid IDLE character (K28.5) with correct disparity was received. The correctly decoded version of this character, per Table 4, is on R _n (7:0). |
| 1 | 0 | 0 | 3 | Out-of-Band Error Detected: A character was received which was not a valid 10B data or control character. Data on R _n (7:0) is invalid. |
| 1 | 0 | 1 | 4 | Disparity Error Detected: A valid 10B character was received which did not have the expected disparity. R _n (7:0) is invalid. |
| 1 | 1 | 0 | 2 | Loss of Synchronization: The receiver state machine is in the Loss-of-Sync state. Data on R _n (7:0) is invalid. |
| 1 | 1 | 1 | 2 | RESYNC: The receiver state machine is in the Re-Synchronization state. Data on R _n (7:0) is a decoded version of K28.1, K28.5 or K28.7. |

Preliminary Datasheet

VSC7216-01

Multi-Gigabit Interconnect Chip

Loopback Operation

Loop back control pins, LBENn(1:0), are provided in each channel to internally loopback data paths for on-chip diagnosis. Both serial and parallel loopback functions are provided.

Table 9: Loopback Mode Selection

| LBENn(1:0) | Loopback Mode |
|------------|----------------------------|
| 0 0 | Normal Operation |
| 0 1 | Internal Parallel Loopback |
| 1 0 | Internal Serial Loopback |
| 1 1 | Reserved |

When LBENn(1:0)=10, Serial Loopback mode is selected, the transmitter's serial transmit data is internally connected to the receiver's CRU input. The serial loopback paths are labeled LBTXn in the VSC7216-01 block diagram on the first page. This allows parallel data on Tn(7:0) to be encoded, serialized, looped back, deserialized and decoded. This mode is intended for the system to verify functionality of the local VSC7216-01 prior to attempting to establish an external link. The PTXn and RTXn outputs are unaffected by the state of LBENn(1:0).

When LBENn(1:0)=01, Parallel Loopback mode is selected. The Rn(7:0) outputs are looped back to the Tn(7:0) inputs (Figure 11). WSENn does not have a loopback source and is internally connected to a logic LOW. KCHAR does not have a loopback source and is internally connected to a logic HIGH. The C/Dn input is obtained by decoding the link status outputs such that either a data character, special character, or IDLE (K28.5) is transmitted. When the link is in the LOS or RESYNC states, C/Dn is asserted and the data path is set to 0xBC so that an IDLE will be transmitted. For other link status conditions C/Dn follows the KCHn status bit. This guarantees that IDLE and special characters will be correctly looped back along with normal data, and also has the effect of looping back the data received as a normal data character when a disparity error, out-of-band character, or underflow/overflow link status condition occurs.

Figure 11: Parallel Loopback Mode Operation

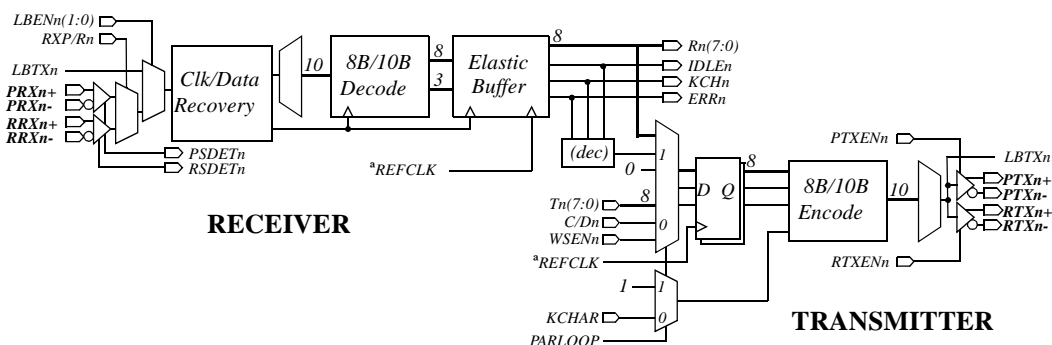

In Parallel Loopback mode the receiver uses an internal copy of REFCLK as the word clock in each receiver. This data is looped back to the transmitter with TMODE(2:0) internally set to 000. This guarantees that the parallel loopback data to be re-transmitted will be frequency-locked to the transmitter's REFCLK, but means that the receiver parallel output data timing will not match the normal system timing that is externally selected by RMODE(1:0), so the parallel output data should be ignored in this mode of operation.

This internal loopback configuration also allows rate matching to be performed in the receivers' elastic buffers. Rate matching is controlled and operates exactly the same way that it does in normal mode. This is needed to avoid receiver Overrun/Underrun errors in the loopback device if the remote transmitting device's REFCLK is not frequency locked to the loopback device's REFCLK. Keep in mind that the LBENn(1:0), RXP/Rn, PTXENn, RTXENn and BIST inputs must all be configured appropriately in order for end-to-end parallel loopback to function correctly in a user environment. Parallel Loopback mode is internally disabled when BIST mode is enabled.

Built-In Self Test Operation

Built-In Self Test operation is enabled when the BIST input is HIGH, which causes TMODE(2:0) to be internally set to 000. Upon entering BIST mode, the transmitter will issue a Word Sync Sequence in order to recenter the elasticity buffers in the receive channel. Each transmitter then repeatedly sends a simple 256-byte incrementing data pattern (prior to 8B/10B encoding) followed by three IDLE characters (K28.5). Note that this incrementing pattern plus three IDLEs will cause both disparities of each data character and the IDLE character to be transmitted, and contains a sufficient IDLE density for any application requiring IDLE insertion/deletion. It is up to the user to enable IDLE insertion/deletion if the receiver's word clock is not frequency-locked to the transmitter's REFCLK.

Each receiver monitors incoming data for this pattern and indicates if any errors are detected. Correct reception of the pattern is reported on each receiver's TBERRn output; a LOW means the pattern is being received correctly and a HIGH means that errors are detected. When BIST transitions from LOW to HIGH, each TBERRn output is initialized HIGH. It will be cleared LOW whenever one or more IDLE characters followed by all 256 data characters are sequentially received without error, and set HIGH whenever a pattern mis-match or receiver error is encountered. Each channel functions independently, no attempt is made to word-align the receive channels. Received data and associated status will be output as in normal operation. Please note that Serial Loopback mode and receiver output timing mode selection via RMODE(1:0) operate independently of BIST mode, but BIST mode disables Parallel Loopback mode.

Figure 12: BIST Mode Operation

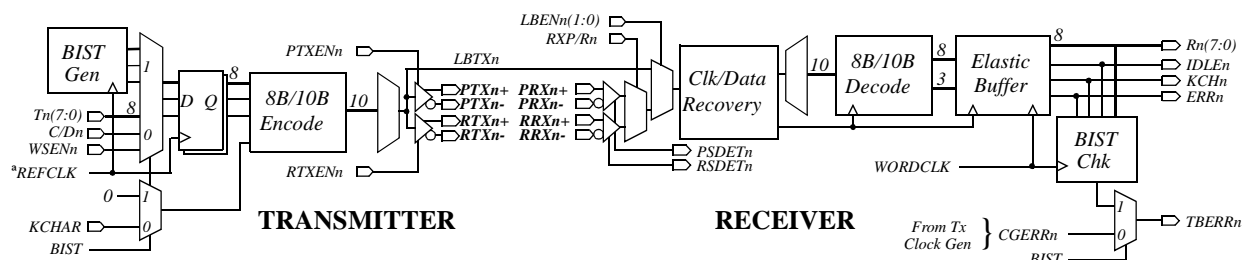

Preliminary Datasheet

VSC7216-01

Multi-Gigabit Interconnect Chip

Compatibility with VSC7214 and VSC7211

Care has been taken in the functional definition of the VSC7216-01 to ensure that it is compatible with the VSC7211 and VSC7214 at the serial link level, and that the transmitter and receiver low-speed interfaces have compatible modes of operation. It is strongly recommended that the VSC7216-01 not be connected in any way through the WSO and/or WSI pins to a VSC7211 or VSC7214.

Serial Link Compatibility

The VSC7216-01 uses the same Fibre Channel 8b/10b encoding scheme and the same Word Sync Sequence used in the VSC7211 and VSC7214. The only difference in serial link operation is that the VSC7211 and VSC7214 require four consecutive identically-aligned “Comma” patterns to set the character framing boundary, while the VSC7216-01 requires a single “Comma.” This means that from the LOSS_OF_SYNC state, the VSC7216-01 will make an earlier transition to the RESYNC state (one “Comma” instead of four) as shown in Figure 9. Once out of the LOSS_OF_SYNC state, there is no difference in receiver behavior in the absence of data link errors. When transmitting in 32-bit mode from a VSC7216-01 to a VSC7211 or VSC7214, use TMODE(2:0)=000 or =1X0 (common transmit interface timing source) to minimize transmitter inter-channel skew.

Parallel Interface Compatibility

In general, the VSC7216-01 low-speed parallel interfaces can be configured so that there are input and output signals that are compatible with their VSC7211 and VSC7214 counterparts. On the transmit interface, the signals Tn(7:0) and C/Dn behave identically on the VSC7216-01 as long as the input timing is referenced to REFCLK (e.g., TMODE(2:0)=000). On the receive interface, the signals Rn(7:0), ERRn, KCHn and IDLEn behave identically on the VSC7216-01 as long as the four receive channels present output data centered around REFCLK (RMODE(1:0)=00) or timed to RCLKA/RCLKNA (RMODE(1:0)=10). When RMODE(1:0)=10, the VSC7216-01 RCLKn/RCLKNn outputs provide four copies of RCLKA/RCLKNA, which are equivalent to the VSC7211 and VSC7214 RCLK/RCLKN outputs.

The VSC7216-01 KCHAR input is no longer a synchronous input timed to REFCLK as on the VSC7211 and VSC7214. It is a static input used to define the control character encoding mode when C/Dn=1, as shown in Table 3. The VSC7216-01 also has a separate WSENn input per channel instead of a common WSYNC input as on the VSC7211 and VSC7214.

Operational Mode Compatibility

The VSC7211 and VSC7214 specifications define eight operating modes based on the binary combinations of the RCLKEN, FLOCK and INDEP inputs. Note that these mode inputs control VSC7211 and VSC7214 receiver operation only, and have no effect on transmitter operation. For each of these modes, the equivalent VSC7216-01 receiver configuration is presented.

VSC7214 MODE 0: RCLKEN=LOW, FLOCK=LOW, INDEP=LOW

Receiver Rn(7:0), ERRn, KCHn and IDLEn outputs are synchronous to REFCLK, IDLE insertion/deletion is enabled, and the receive channels are word-aligned. The VSC7216-01 should be configured with RMODE(1:0)=00, FLOCK=0, and WSI connected to its own WSO or to the WSO of another VSC7216-01 if multiple devices are to be used in parallel. The WSI connection allows IDLE insertion/deletion to occur in parallel across all word-aligned channels.

VSC7214 MODE 1: RCLKEN=LOW, FLOCK=LOW, INDEP=HIGH

Receiver Rn(7:0), ERRn, KCHn and IDLEn outputs are synchronous to REFCLK, IDLE insertion/deletion is enabled, and the receive channels are independent. The VSC7216-01 should be configured with RMODE(1:0)=00, FLOCK=0, and WSI=1. The WSI connection inhibits channel alignment, and allows IDLE insertion/deletion to occur independently in each channel.

VSC7214 MODE 2: RCLKEN=LOW, FLOCK=HIGH, INDEP=LOW

Receiver Rn(7:0), ERRn, KCHn and IDLEn outputs are synchronous to REFCLK, IDLE insertion/deletion is disabled, and the receive channels are word-aligned. The VSC7216-01 should be configured with RMODE(1:0)=00, FLOCK=1, and WSI connected to its own WSO or to the WSO of another VSC7216-01 if multiple devices are to be used in parallel. The WSI connection allows word alignment to occur, and the FLOCK connection inhibits IDLE insertion/deletion.

VSC7214 MODE 3: RCLKEN=LOW, FLOCK=HIGH, INDEP=HIGH

Receiver Rn(7:0), ERRn, KCHn and IDLEn outputs are synchronous to REFCLK, IDLE insertion/deletion is disabled, and the receive channels are independent. The VSC7216-01 should be configured with RMODE(1:0)=00, FLOCK=1, and WSI=0. The WSI connection inhibits channel alignment, and the FLOCK connection inhibits IDLE insertion/deletion.

VSC7214 MODE 4: RCLKEN=HIGH, FLOCK=LOW, INDEP=LOW

This configuration does not require IDLE insertion/deletion, use Mode 6 instead.

VSC7214 MODE 5: RCLKEN=HIGH, FLOCK=LOW, INDEP=HIGH

Receiver Rn(7:0), ERRn, KCHn and IDLEn outputs are synchronous to RCLKn/RCLKNn, IDLE insertion/deletion is enabled, and the receive channels are independent. The VSC7216-01 should be configured with RMODE(1:0)=10, FLOCK=0, and WSI=1. The WSI connection inhibits channel alignment, and allows IDLE insertion/deletion to occur independently in each channel. The B, C and D channel RCLKn/RCLKNn outputs are copies of RCLKA/RCLKNA.

VSC7214 MODE 6: RCLKEN=HIGH, FLOCK=HIGH, INDEP=LOW

Receiver Rn(7:0), ERRn, KCHn and IDLEn outputs are synchronous to RCLKn/RCLKNn, IDLE insertion/deletion is disabled, and the receive channels are word-aligned. The VSC7216-01 should be configured with RMODE(1:0)=10, FLOCK=1, and WSI connected to its own WSO. Multiple VSC7216-01 devices should not be used in parallel when the outputs are synchronous to RCLKn/RCLKNn. The WSI connection allows word alignment to occur, and the FLOCK connection inhibits IDLE insertion/deletion.

VSC7214 MODE 7: RCLKEN=HIGH, FLOCK=HIGH, INDEP=HIGH

Receiver Rn(7:0), ERRn, KCHn and IDLEn outputs are synchronous to RCLKn/RCLKNn, IDLE insertion/deletion is disabled, and the receive channels are independent. The VSC7216-01 should be configured with RMODE(1:0)=10, FLOCK=1, and WSI=0. The WSI connection inhibits channel alignment, and the FLOCK connection inhibits IDLE insertion/deletion.

Preliminary Datasheet

VSC7216-01

Multi-Gigabit Interconnect Chip

AC Specifications

Figure 13: Transmit Input Timing Waveforms with $TMODE = 000$

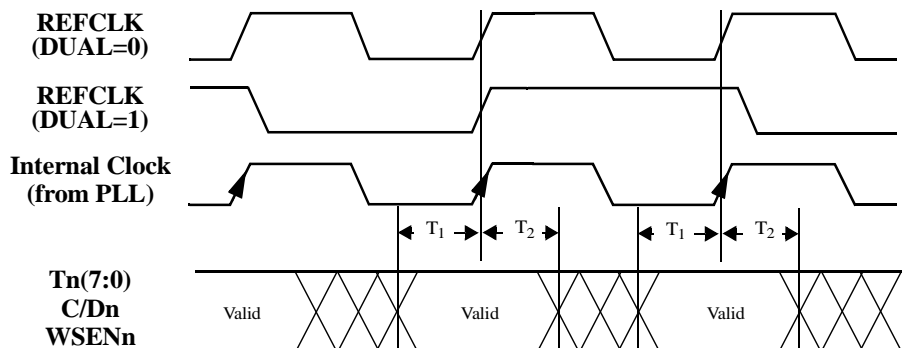

Figure 14: Transmit Input Timing Waveforms with $TMODE = 10X$

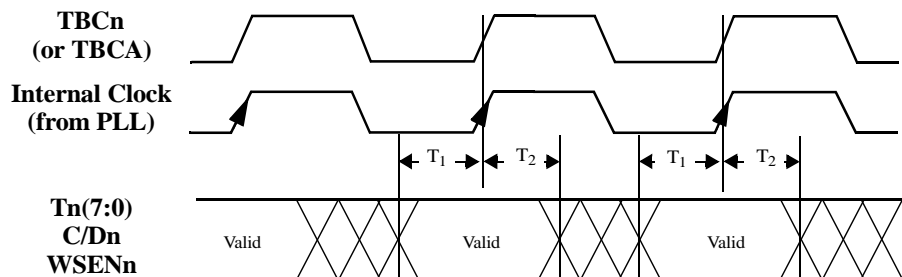

Table 10: Transmit Input AC Characteristics with $TMODE = 000$ or $TMODE = 10X$

| Parameters | Description | Min | Max | Units | Conditions |
|------------|---|-----|-----|-------|---|
| T_1 | Input setup time to the rising edge of REFCLK or TBCn | 1.5 | — | ns | Measured between the valid data level of the input and the 1.4V point of REFCLK or TBCn |
| T_2 | Input hold time after the rising edge of REFCLK or TBCn | 1.0 | — | ns | |

Figure 15: Transmit Input Timing Waveforms with $TMODE = 11X$ (“ASIC-Friendly” Timing)

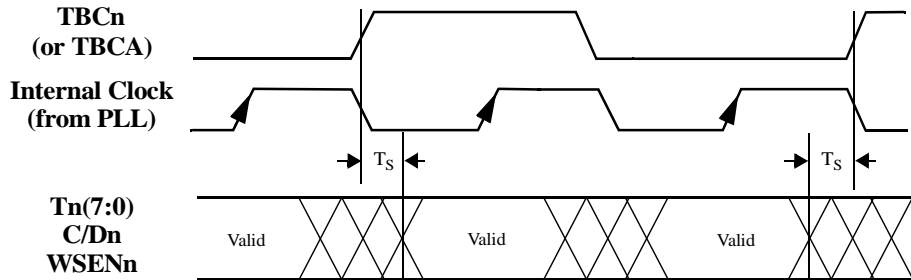

Table 11: Transmit Input AC Characteristics with $TMODE = 11X$

| Parameters | Description | Min | Max | Units | Conditions |
|------------|--|-----|-----|-------|--|
| T_S | Input Skew relative to the rising edge of TBCn or TBCA | — | 2.0 | bc | Measured between the valid data level of the input and the 1.4V point of TBCn or TBCA. bc = bit clock. |

Figure 16: Transmit Serial Timing Waveforms

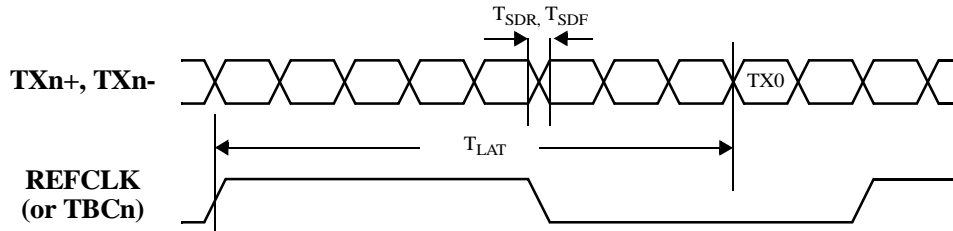

Table 12: Transmit Serial AC Characteristics

| Parameters | Description | Min | Max | Units | Conditions |
|--------------------|--|--|--|---------|---|
| T_{SDR}, T_{SDF} | TXn+/- rise and fall time | — | 330 | ps | Measured between 20% to 80% of the valid data level. |
| T_{LAT} | Latency, REFCLK to TX0 Latency, TBCA to TX0 Latency, TBCB/C/D to TX0 | 22bc+0.1ns 38bc+0.4ns 32bc+0.1ns | 22bc+0.7ns 40bc+0.7ns 42bc+0.6ns | bc + ns | ENDEC=1 $TMODE=000$ ENDEC=1 $TMODE=10X$ ENDEC=1 $TMODE=101$ |
| T_J | Serial data output Total Jitter (p-p) | — | 192 | ps | IEEE 802.3z Clause 38.69, tested on a sample basis. |
| T_{DJ} | Serial data output Deterministic Jitter (p-p) | — | 80 | ps | IEEE 802.3z Clause 38.69, tested on a sample basis. |

Preliminary Datasheet

VSC7216-01

Multi-Gigabit Interconnect Chip

Figure 17: Receive Output Timing Waveforms with $RMODE = 00$ or 01

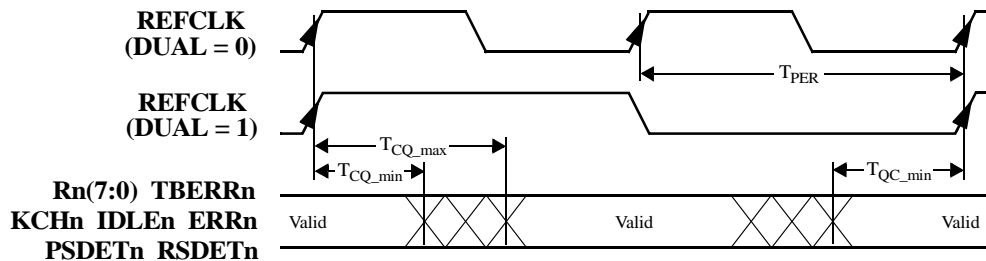

Table 13: Receive Output AC Characteristics with $RMODE = 00$ or 01

| Parameters | Description | Min | Max | Units | Conditions |
|------------|---|-------------------------|----------------|-------|--------------------------------|
| T_{CQ} | REFCLK Rising Edge to TTL Output Transition | 2.2 ns - 0 bc | 5.05 ns - 0 bc | ns | $RMODE = 00$ bc = bit clock |
| T_{CQ} | REFCLK Rising Edge to TTL Output Transition | 2.2 ns - 2 bc | 5.05 ns - 2 bc | ns | $RMODE = 01$ bc = bit clock |
| T_{QC} | TTL Output Transition to REFCLK Rising Edge | $T_{PER} - T_{CQ_max}$ | | ns | |

Figure 18: Receive Output Timing Waveforms with $RMODE = 10$ or 11

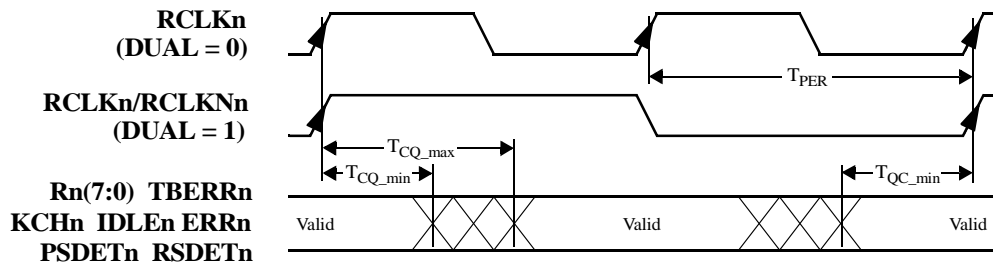

Table 14: Receive Output AC Characteristics with $RMODE = 10$ or 11

| Parameters | Description | Min | Max | Units | Conditions |
|------------|---|-------------------------|-------------------------|-------|--|
| T_{CQ} | RCLKn/RCLKNn Rising Edge to TTL Output Transition | -1.25 ns + 4 bc | 1.25 ns + 4 bc | ns | $RMODE = 10$ or 11 . bc = bit clock |
| T_{CQ} | TTL Output Transition to RCLKn/RCLKNn Rising Edge | $T_{PER} - T_{CQ_max}$ | $T_{PER} - T_{CQ_min}$ | ns | |
| DC | RCLKn/RCLKNn Duty Cycle | 50% - 1 ns | 50% + 1 ns | ns | Measured at 1.4 V |

Figure 19: RCLKn and RCLKNn Timing Waveforms with DUAL = 1

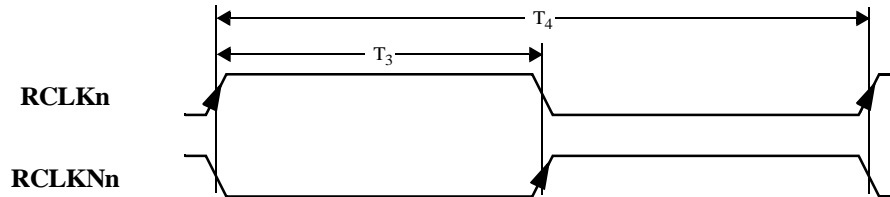

Table 15: General Receive AC Characteristics

| Parameters | Description | Min. | Typ | Max. | Units | Conditions |
|----------------------------------|---|--------------------------------------|-----|---------------------------------------|-------|--|
| T ₃ | Delay between rising edge of RCLKn to rising edge of RCLKNn | 10 x T _{RX} -500 | | 10 x T _{RX} +500 | ps | T _{RX} is the bit period of the incoming data on Rx. |
| ΔT ₃ | RCLKn to RCLKNn skew $Delay = \frac{10}{f_{baud}} \pm \Delta T_3$ | -500 | | 500 | ps | Deviation of RCLKn rising edge to RCLKNn rising edge. Nominal delay is 10 bit times. |
| T ₄ | Period of RCLKn and RCLKNn | 0.99 x T _{REFCLK} | | 1.01 x T _{REFCLK} | ps | Whether or not locked to serial data, independent of DUAL input. |
| ΔT ₄ | Deviation of RCLK/RCLKN period from REFCLK period $T_{RCLK} = T_{REFCLK} \pm \Delta T_4$ | -1.0 | | 1.0 | % | Whether or not locked to serial data, independent of DUAL input. |
| T _R , T _F | Output rise and fall time | — | | 2.4 | ns | Between V _{IL(MAX)} and V _{IH(MIN)} into 10pF load |
| R _{LAT} | Latency from RX0 to REFCLK or RCLK | 70.5bc- 1.6ns 48.5bc- 1.6ns | | 81.5bc+4 .1ns 102.5bc+ 4.1ns | bc+ns | ENDEC=1, recenter only ENDEC=X, recenter + drift |
| T _{LOCK} ⁽¹⁾ | Data acquisition lock time | — | | 2500 | bc | Using K28.5+/K28.5- pattern. Tested on a sample basis. |
| T _{JTD} | Receive data Total Jitter Tolerance (p-p) | | | 600 | ps | IEEE 802.3z Clause 38.68, tested on a sample basis. |
| D _{JTD} | Receive data Deterministic Jitter Tolerance (p-p) | | | 370 | ps | IEEE 802.3z Clause 38.69, tested on a sample basis. |

NOTE: (1) The probability of correct data acquisition and recovery is 99% per FC-PH 4.3 Section 5.3.

Preliminary Datasheet

VSC7216-01

Multi-Gigabit Interconnect Chip

Figure 20: REFCLK Timing Waveforms

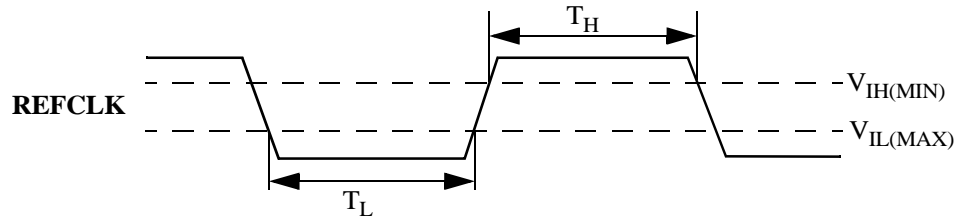
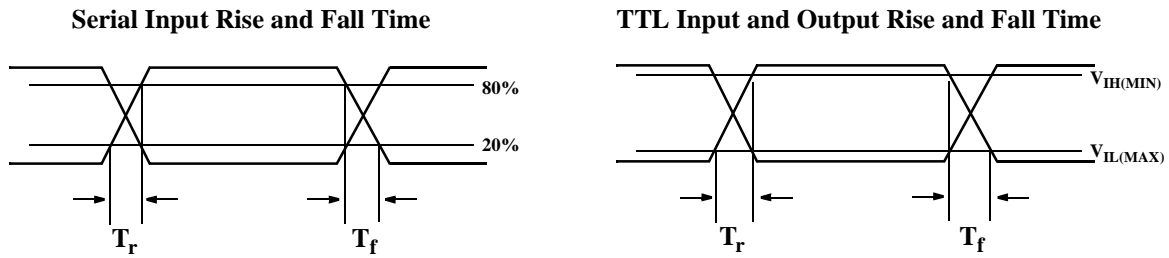

Table 16: Reference Clock Requirements

| Parameters | Description | Min | Max | Units | Conditions |
|--------------------|--|------|-----|-------|---|
| FR | Frequency range | 98 | 136 | MHz | DUAL = 0, RATE = 1 |
| | | 49 | 68 | MHz | DUAL = 1, RATE = 1 |
| | | 49 | 68 | MHz | DUAL = 0, RATE = 0 |
| | | 24.5 | 34 | MHz | DUAL = 1, RATE = 0 |
| FO | Frequency offset | -200 | 200 | ppm | $ \text{REFCLK (Tx)} - \text{REFCLK (Rx)} =$ max offset between Tx and Rx device REFCLKs on one serial link. |
| DC | REFCLK duty cycle | 35 | 65 | % | Measured at 1.4V |
| T_H, T_L | REFCLK and TBC pulse width | 3 | — | ns | |
| T_{RCR}, T_{RCF} | REFCLK rise and fall time | — | 1.5 | ns | Between $V_{IL(MAX)}$ and $V_{IH(MIN)}$ |
| REFCLK Jitter | REFCLK jitter power $\int_{100Hz}^{3MHz} \text{PhaseNoise}$ | — | 100 | ps | Peak-to-peak jitter at VSC7216-01 REFCLK input. |

Figure 21: Parametric Measurement Information



Receiver Input Eye Diagram Jitter Tolerance Mask

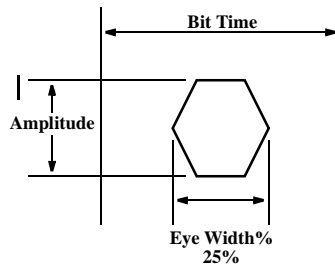

Parametric Test Load Circuit

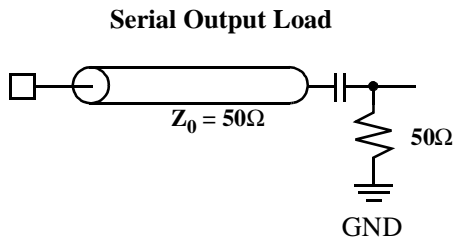

TTL AC Output Load

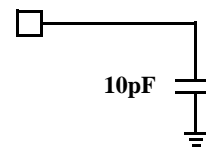

Preliminary Datasheet

VSC7216-01

Multi-Gigabit Interconnect Chip

DC Characteristics

Table 17: DC Characteristics

| Parameters | Description | Min. | Typ | Max. | Units | Conditions |
|--|---|-----------------------|--------------------|-----------------------|-------|--|
| TTL Outputs (Rn(7:0), KCHn, IDLEn, ERRn, RCLKn/RCLKNn, TBERRn, PSDEtn, RSEDEtn, WSO) | | | | | | |
| V _{OH} | TTL output HIGH voltage | 2.4 | — | — | V | I _{OH} = -1.0mA |
| V _{OL} | TTL output LOW voltage | — | — | 0.5 | V | I _{OL} = +1.0mA |
| I _{OZ} | TTL output leakage current | — | — | TBD | μA | When set to high-impedance state through JTAG. |
| TTL Inputs (TBCn, Tn(7:0), C/Dn, WSEn, KCHAR, RATE, BIST, LBENn(1:0), TMODE(2:0), RMODE(1:0), DUAL, PTXENn, RTXENn, RXP/Rn, RESETN, ENDEC, WSI, FLOCK, TRSTN, TDI, TDO, TMS, TCK) | | | | | | |
| V _{IH9} | TTL input HIGH voltage | 2.0 | — | — | V | |
| V _{IL} | TTL input LOW voltage | 0 | — | 0.8 | V | |
| I _{IH} | TTL input HIGH current | — | 50 | 500 | μA | V _{IN} = 2.4V |
| I _{IL} | TTL input LOW current | — | — | -1000 | μA | V _{IN} = 0.5V |
| PECL Inputs (REFCLKP/REFCLKN) | | | | | | |
| V _{IH} | PECL input HIGH voltage | V _{DD} - 1.1 | — | V _{DD} - 0.7 | V | |
| V _{IL} | PECL input LOW voltage | V _{DD} - 2.0 | — | V _{DD} - 1.5 | V | |
| I _{IH} | PECL input HIGH current | — | — | 200 | μA | V _{IN} = V _{IH(MAX)} |
| I _{IL} | PECL input LOW current | -50 | — | — | μA | V _{IN} = V _{IL(MIN)} |
| ΔV _{IN} | PECL input differential peak-to-peak voltage swing | 200 | — | — | mV | V _{IH(MIN)} - V _{IL(MAX)} ⁽¹⁾ |
| V _{CM} | PECL input common-mode voltage | V _{DD} - 1.5 | — | V _{DD} - 0.7 | V | |
| V _{BIAS} | REFCLKP/REFCLKN internal input bias voltage | — | V _{DD} /2 | — | | |
| PECL Outputs (PTXn+/-, RTXn+/-) | | | | | | |
| ΔV _{OUT} | PECL differential peak-to-peak output voltage swing | 500 | — | 1100 | mV | PTXn+ - PTXn- ⁽¹⁾ 50Ω to GND. External pull-down resistors not required. |
| PECL Inputs (PRXn+/-, RRXn+/-) | | | | | | |
| ΔV _{IN} | PECL differential peak-to-peak input voltage swing | 200 | — | 1300 | mV | PRXn+ - PRXn- ⁽¹⁾ |
| Miscellaneous | | | | | | |
| V _{DD} | Power supply voltage | 3.14 | — | 3.47 | V | 3.3V ± 5% |
| P _D | Power dissipation | — | 3.0 | 3.2 | W | Maximum at 3.47V, at 130MHz, redundant I/O off. Typical at 3.3V, outputs open. |
| I _{DD} | Supply current | — | 910 | 925 | mA | |

NOTE: (1) Single-ended measurement results are quoted here. Differential techniques used in Fibre Channel would yield values that are twice the magnitude. See diagram below.

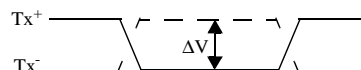

Absolute Maximum Ratings ⁽¹⁾

| | |
|---|--------------------------|
| Power Supply Voltage (any V_{DDX}) | 0.5V to +3.8V |
| PECL Differential Input Voltage | -0.5V to $V_{DD} + 0.5V$ |
| TTL Input Voltage..... | -0.5V to 5.5V |
| TTL Output Voltage..... | -0.5V to $V_{DD} + 0.5V$ |
| TTL Output Current..... | 50mA |
| PECL Output Current | 50mA |
| Case Temperature Under Bias (T_C) | -55°C to +125°C |
| Storage Temperature (T_{STG})..... | -65°C to +150°C |

NOTE: (1)CAUTION: Stresses listed under "Absolute Maximum Ratings" may be applied to devices one at a time without causing permanent damage. Functionality at or above the values listed is not implied. Exposure to these values for extended periods may affect device reliability.

Recommended Operating Conditions

| | |
|--|---------------------------|
| Power Supply Voltage (V_{DD})..... | +3.3V \pm 5% |
| Operating Temperature Range | 0°C Ambient to +95°C Case |

Preliminary Datasheet

VSC7216-01

Multi-Gigabit Interconnect Chip

Package Pin Descriptions

Figure 22: Pin Diagram

| 1 | 2 | 3 | 4 | 5 | 6 | 7 | 8 | 9 | 10 | 11 | 12 | 13 | 14 | 15 | 16 | 17 | 18 | 19 | 20 | | | | | | | | | | | | | |
|-------|--------|--------|--------|----------------------|--------|------|---------|---------|-----|------|-------|-------|-------|------|------|--------|--------|--------|--------|----------|-----|------|--------|------|------|-----|------|--------|--------|--------|-----|----------|
| PRXC+ | PRXC- | RRXC+ | RRXC- | TD4 | C/DD | VSSD | REFCLKP | TC0 | TC4 | VSSD | TC7 | TRSTN | TDI | TCK | RC0 | RC3 | RC4 | VSST | ERRC | A | | | | | | | | | | | | |
| RRXD+ | RRXD- | RXP/RC | TMODE2 | TD0 | TD2 | TD5 | WSEND | TBCC | TC3 | VDDD | C/DC | TMS | VDDT | RC2 | VSST | VDDT | TBERRC | VDDT | RD0 | B | | | | | | | | | | | | |
| VDDD | RXP/RD | VSSD | VSSD | VDDD | TD1 | VSSD | TD6 | TBCD | TC1 | TC6 | WSENC | VSSD | VSST | RC6 | RC7 | IDLEC | VSST | RSDETC | RD3 | C | | | | | | | | | | | | |
| PRXD+ | PRXD- | LBENC1 | VDDD | TMODE0 | TMODE1 | TD3 | TD7 | REFCLKN | TC2 | TC5 | BIST | VDDD | RC1 | RC5 | KCHC | VDDT | PSDETC | RD1 | VSST | D | | | | | | | | | | | | |
| RTXD+ | RTXD- | LBEND1 | VSSD | NOT POPULATED | | | | | | | | | | | | RCLKNC | RCLKC | VDDT | RD7 | E | | | | | | | | | | | | |
| PTXD+ | PTXD- | VDDRD | LBENC0 | | | | | | | | | | | | | RD2 | VSST | RD4 | ERRD | F | | | | | | | | | | | | |
| VDDRC | VDDPD | RTXEND | LBEND0 | | | | | | | | | | | | | RD5 | RD6 | VDDT | VSST | G | | | | | | | | | | | | |
| RTXC+ | RTXC- | RTXENC | PTXEND | | | | | | | | | | | | | VDDT | KCHD | IDLED | TBERRD | H | | | | | | | | | | | | |
| PTXC+ | PTXC- | VDDPC | PTXENC | | | | | | | | | | | | | PSDETD | VSST | VDDT | RSDETD | J | | | | | | | | | | | | |
| CAP0 | VSSA | VSSD | VSSA | | | | | | | | | | | | | RCLKD | RCLKND | TDO | VDDD | K | | | | | | | | | | | | |
| CAP1 | VDDA | VDDD | VDDA | | | | | | | | | | | | | WSO | VDDT | VSSD | WSI | L | | | | | | | | | | | | |
| PTXB+ | PTXB- | VDDPB | PTXENB | | | | | | | | | | | | | RSDETA | VSST | RCLKNA | RCLKA | M | | | | | | | | | | | | |
| RTXB+ | RTXB- | RTXENB | PTXENA | | | | | | | | | | | | | IDLEA | ERRA | VDDT | VSST | N | | | | | | | | | | | | |
| VDDRB | VDDPA | RTXENA | LBENA0 | | | | | | | | | | | | | VDDT | RA7 | KCHA | PSDETA | P | | | | | | | | | | | | |
| PTXA+ | PTXA- | VDDRA | LBENB0 | | | | | | | | | | | | | RA3 | VSST | RA6 | TBERRA | R | | | | | | | | | | | | |
| RTXA+ | RTXA- | LBENA1 | VSSD | | | | | | | | | | | | | RCLKB | RA0 | VDDT | VSST | T | | | | | | | | | | | | |
| PRXA+ | PRXA- | LBENB1 | VDDD | | | | | | | | | | | | | DUAL | RMODE0 | TA2 | TA6 | TBCA | TB3 | TB7 | RESETN | VSSD | RB2 | RB6 | ERRB | VDDT | RSDETB | RA2 | RA5 | U |
| VDDD | RXP/RA | VSSD | VSSD | | | | | | | | | | | | | VDDD | VSSD | TA3 | VDDD | TBCB | TB2 | C/DB | ENDEC | RB0 | VSST | RB7 | KCHB | TBERRB | VSST | PSDETB | RA4 | V |
| RRXA+ | RRXA- | RXP/RB | RMODE1 | TA0 | TA1 | TA5 | VSSD | TB0 | TB4 | TB6 | KCHAR | FLOCK | VDDT | RB3 | VSST | VDDT | IDLEB | VDDT | RA1 | W | | | | | | | | | | | | |
| PRXB+ | PRXB- | RRXB+ | RRXB- | TA4 | TA7 | C/DA | WSENA | TB1 | TB5 | VDDD | WSENB | RATE | RSVD2 | VDDD | RB1 | RB4 | RB5 | VSST | RCLKNB | Y | | | | | | | | | | | | |

Table 18: Pin Identifications

| Pin | Name | I/O | Type | Pin Description |
|--|--------------------------------------|-----|------|--|
| 6Y, 8U, 7W, 5Y, 7V, 7U, 6W, 5W | TA(7:0) | I | TTL | T ransmit data for channel n , synchronous to REFCLK, TBCA or TBCn. |
| 11U, 11W, 10Y, 10W, 10U, 10V, 9Y, 9W | TB(7:0) | I | TTL | T ransmit data for channel n , synchronous to REFCLK, TBCB or TBCn. |
| 12A, 11C, 11D, 10A, 10B, 10D, 10C, 9A | TC(7:0) | I | TTL | T ransmit data for channel n , synchronous to REFCLK, TBCC or TBCn. |
| 8D, 8C, 7B, 5A, 7D, 6B, 6C, 5B | TD(7:0) | I | TTL | T ransmit data for channel n , synchronous to REFCLK, TBCD or TBCn. |
| 7Y 11V 12B 6A | C/DA C/DB C/DC C/DD | I | TTL | C ontrol/ D ata for channel n . If KCHAR=C/Dn=LOW, Tn(7:0) is used to generate transmit data. If KCHAR=C/Dn=HIGH, special Kxx.x characters are transmitted based upon the value of Tn(7:0). If KCHAR=LOW and C/Dn=HIGH, IDLE characters are transmitted. When ENDEC=LOW, this is equivalent to data bit Tn8 . |
| 8Y 12Y 12C 8B | WSENA WSENB WSENC WSEND | I | TTL | W ord S ync E Nable for channel n . Asserted HIGH for one cycle to initiate transmission of the Word Sync Sequence as defined in Figure 5 and related text. When ENDEC=LOW, this is equivalent to data bit Tn9 . |
| 9U 9V 9B 9C | TBCA TBCB TBCC TBCD | I | TTL | T ransmit B yte C lock for channel n . Optional input data timing reference for Tn(7:0), WSENn and C/Dn. |
| 12W | KCHAR | I | TTL | Special Kxx.x CHAR acter enable. When C/Dn is HIGH, KCHAR controls data sent to the transmitter. When LOW, IDLE characters are sent. When HIGH, Kxx.x special characters are sent as encoded on Tn(7:0). This is intended to be a static input and cannot be changed on a cycle-by-cycle basis. When ENDEC=LOW, this is equivalent to ENCDET . |
| 5D 6D 4B | TMODE0 TMODE1 TMODE2 | I | TTL | T ransmit input data timing MODE . Determines the timing reference for Tn(7:0), WSENn and C/Dn on all channels as defined in Table . |
| 20R 17V 18B 20H | TBERRA TBERRB TBERRC TBERRD | O | TTL | T ransmit B uffer E RRor for channel n . When HIGH indicates that the elastic limit of the transmit input skew buffer was exceeded, output timing is same as Rn(7:0). A LOW indicates correct reception of the 256-byte incrementing pattern in BIST mode. |

Preliminary Datasheet

VSC7216-01

Multi-Gigabit Interconnect Chip

| Pin | Name | I/O | Type | Pin Description |
|--|--|-----|------|--|
| 1R, 2R 1M, 2M 1J, 2J 1F, 2F | PTXA+/- PTXB+/- PTXC+/- PTXD+/- | O | PECL | P Primary differential serial T X outputs for channel n . These pins output serialized transmit data when PTXENn is HIGH. AC-coupling is recommended. |
| 1T, 2T 1N, 2N 1H, 2H 1E, 2E | RTXA+/- RTXB+/- RTXC+/- RTXD+/- | O | PECL | R edundant differential serial T X outputs for channel n . These pins output serialized transmit data when RTXENn is HIGH. AC-coupling is recommended. |
| 4N 4M 4J 4H | PTXENA PTXENB PTXENC PTXEND | I | TTL | P Primary T X output E Nable for channel n . When HIGH PTXn+/- is active; when LOW, PTXn+/- is powered down and the outputs are un-driven. |
| 3P 3N 3H 3G | RTXENA RTXENB RTXENC RTXEND | I | TTL | R edundant T X output E Nable for channel n . When HIGH, RTXn+/- is active; when LOW, RTXn+/- is powered down and the outputs are un-driven. |
| 18P, 19R 20U, 20V 17R, 19U 20W, 18T | RA(7:0) | O | TTL | R ecieve data for channel A. Synchronous to RCLKA/RCLKNA or REFCLK as selected by RMODE(1:0). |
| 15V, 15U 18Y, 17Y 15W, 14U 16Y, 13V | RB(7:0) | O | TTL | R ecieve data for channel B. Synchronous to RCLKB/RCLKNB or REFCLK as selected by RMODE(1:0). |
| 16C, 15C 15D, 18A 17A, 15B 14D, 16A | RC(7:0) | O | TTL | R ecieve data for channel C. Synchronous to RCLKC/RCLKNC or REFCLK as selected by RMODE(1:0). |
| 20E, 18G 17G, 19F 20C, 17F 19D, 20B | RD(7:0) | O | TTL | R ecieve data for channel D. Synchronous to RCLKD/RCLKND or REFCLK as selected by RMODE(1:0). |
| 17N 18W 17C 19H | IDLEA IDLEB IDLEC IDLED | O | TTL | I DLE detect for channel n . When HIGH, an IDLE character has been detected by the decoder and is on Rn(7:0). When ENDEC=LOW, this is equivalent to COMDETn . |
| 19P 16V 16D 18H | KCHA KCHB KCHC KCHD | O | TTL | K xx.x C haracter detect for channel n . When HIGH, a special Kxx.x character has been detected by the decoder and is on Rn(7:0). When ENDEC=LOW, this is equivalent to data bit Rn8 . |
| 18N 16U 20A 20F | ERRA ERRB ERRC ERRD | O | TTL | E RRor detect for channel n . When HIGH, an invalid 10-bit character or disparity error has been detected and the data on Rn(7:0) is invalid. When ENDEC=LOW, this is equivalent to data bit Rn9 . |

Multi-Gigabit Interconnect Chip

| Pin | Name | I/O | Type | Pin Description |
|--|--|-----|--------|--|
| 20M 19M 17T 20Y 18E 17E 17K 18K | RCLKA RCLKNA RCLKB RCLKNB RCLKC RCLKNC RCLKD RCLKND | O | TTL | Recovered CLocK outputs for channel n . These outputs are driven from either the channel A or channel n recovered clock, at 1/10 or 1/20 the baud rate, as selected by RMODE(1:0) and DUAL. When unused, RCLKn is LOW and RCLKNn is HIGH. |
| 6U 4W | RMODE0 RMODE1 | I | TTL | Receive output data timing MODE . Determines the timing reference for all receive channels' Rn(7:0), IDLEn, KCHn and ERRn output data. Also for the PSDETn, RSDETn and TBERRn outputs, as defined in Table 6. |
| 1U, 2U 1Y, 2Y 1A, 2A 1D, 2D | PRXA+/- PRXB+/- PRXC+/- PRXD+/- | I | PECL | Primary differential serial RX inputs for channel n . These pins receive the serialized input data when LBENn(1) is LOW and RXP/Rn is HIGH; otherwise they are unused. They are internally biased at V _{DD} /2 through a 3.2kΩ resistor to the bias voltage. AC-coupling is recommended. |
| 1W, 2W 3Y, 4Y 3A, 4A 1B, 2B | RRXA+/- RRXB+/- RRXC+/- RRXD+/- | I | PECL | Redundant differential serial RX inputs for channel n . These pins receive the serialized input data when LBENn(1) is LOW and RXP/Rn is LOW; otherwise they are unused. They are internally biased at V _{DD} /2 through a 3.2kΩ resistor to the bias voltage. AC-coupling is recommended. |
| 4P 3T 4R 3U 4F 3D 4G 3E | LBENA0 LBENA1 LBENB0 LBENB1 LBENC0 LBENC1 LBEND0 LBEND1 | I | TTL | Loop Back ENable for channel n . These inputs control the channel serial or parallel loopback configuration as described in Table 9. |
| 2V 3W 3B 2C | RXP/RA RXP/RB RXP/RC RXP/RD | I | TTL | RX input Primary/Redundant serial input select for channel n . When LBENn(1) is LOW, this input selects PRXn+/- as the RX serial input source when HIGH and RRXn+/- as the serial input source when LOW. |
| 20P 19V 18D 17J | PSDETA PSDETB PSDETC PSDETD | O | TTL | Primary analog Signal DETect , channel n . This output goes HIGH when the amplitude on PRXn is greater than 200mV, LOW when the input is less than 100mV. PSDETn is not defined when the input is between 100mV and 200mV. Output timing is same as Rn(7:0). |
| 17M 18U 19C 20J | RSDETA RSDETB RSDETC RSDETD | O | TTL | Redundant analog Signal DETect , channel n . This output goes HIGH when the amplitude on RRXn is greater than 200 mV, LOW when the input is less than 100mV. RSDETn is not defined when the input is between 100mV and 200mV. Output timing is same as Rn(7:0). |
| 8A 9D | REFCLKP REFCLKN | I | PECL | REFCLK differential Positive and Negative PECL or single-ended TTL inputs. This rising edge of this clock latches transmit data and control into the input register. It also provides the reference clock, at 1/10th or 1/20th of the baud rate to the PLL as selected by DUAL. If TTL, connect to REFCLKP but leave REFCLKN open. If PECL, connect both REFCLKP and REFCLKN. |
| 1K 1L | CAPO CAPI | | Analog | Loop Filter CAPacitor for clock generation PLL. Nominally 0.1μF, amplitude is less than 3V. See the Loop Filter Applications section for more details. |

Preliminary Datasheet

VSC7216-01

Multi-Gigabit Interconnect Chip

| Pin | Name | I/O | Type | Pin Description |
|---|--------|-----|------|--|
| 5U | DUAL | I | TTL | DUAL clock Mode. When LOW, REFCLK and RCLKn/RCLKNn are 1/10th the baud rate. When HIGH, they are 1/20th the baud rate. |
| 13W | FLOCK | I | TTL | F requency L OCKed mode. When HIGH indicates that each transmit channel's REFCLK is frequency-locked to the receive channel's word clock. Controls rate matching (IDLE delete/duplicate) logic along with the WSI input as per Table 7. |
| 12D | BIST | I | TTL | B uilt- I n S elf T est mode. When HIGH, all transmit channels continuously send a 256 byte incrementing data pattern, and all receive channels signal correct reception of the test pattern with a LOW on the TBERRn outputs. |
| 12V | ENDEC | I | TTL | E Ncoder/ D ECode enable. When HIGH the VSC7216-01 is configured for 8-bit operation, internal 8B/10B encoding is enabled. When LOW a 10-bit interface is used, internal 8B/10B encoding is bypassed. |
| 12U | RESETN | I | TTL | R ESETN input. When asserted LOW, the transmitter input skew buffers and receiver elastic buffers are recentered. |
| 20L | WSI | I | TTL | W ord S ync I nput. Used to control channel alignment and IDLE character insertion/deletion as defined in Table 7. |
| 17L | WSO | O | TTL | W ord S ync O utput. Used to set initial channel word alignment, and to maintain alignment by controlling IDLE character insertion/deletion. |
| 15A | TCK | I | TTL | JTAG Test Access Port test clock input |
| 13B | TMS | I | TTL | JTAG Test Access Port test mode select input |
| 14A | TDI | I | TTL | JTAG Test Access Port test data input |
| 19K | TDO | O | TTL | JTAG Test Access Port test data output |
| 13A | TRSTN | I | TTL | JTAG Test Access Port test logic reset input |
| 14Y | RSVD | I | N/A | Reserved Inputs for future use. Set HIGH for compatibility reasons. |
| 13Y | RATE | I | TTL | R ATE Mode. When HIGH, VSC7216-01 runs at full data rate (default mode). When asserted LOW, half-speed data rate is selected. |
| 2L, 4L | VDDA | | VDD | Analog power supply to PLL. |
| 2K, 4K | VSSA | | GND | Analog ground to PLL. |
| 11B, 11Y, 13D, 15Y, 1C, 1V, 20K, 3L, 4D, 4U, 5C, 5V, 8V | VDDD | | VDD | Digital power supply. |
| 11A, 13C, 13U, 19L, 3C, 3K, 3V, 4C, 4E, 4T, 4V, 6V, 7A, 7C, 8W | VSSD | | GND | Digital ground. |

Multi-Gigabit Interconnect Chip

| <i>Pin</i> | <i>Name</i> | <i>I/O</i> | <i>Type</i> | <i>Pin Description</i> |
|---|---|------------|-------------|--|
| 14B, 14W, 17B, 17D, 17H, 17P, 17U, 17W, 18L, 19B, 19E, 19G, 19J, 19N, 19T, 19W | VDDT | | VDD | TTL output power supply. |
| 14C, 14V, 16B, 16W, 18C, 18F, 18J, 18M, 18R, 18V, 19A, 19Y, 20D, 20G, 20N, 20T | VSST | | GND | TTL output ground. |
| 2P 3R 3M 1P 3J 1G 2G 3F | VDDPA VDDRA VDDPB VDDRBB VDDPC VDDRC VDDPD VDDRD | | VDD | PECL Output power supply for PTXA. PECL Output power supply for RTXA. PECL Output power supply for PTXB. PECL Output power supply for RTXB. PECL Output power supply for PTXC. PECL Output power supply for RTXC. PECL Output power supply for PTXD. PECL Output power supply for RTXD. If use of an output is not necessary, leave the power supply pin open. |

Preliminary Datasheet
VSC7216-01

Multi-Gigabit Interconnect Chip

Package Information

256-pin BGA

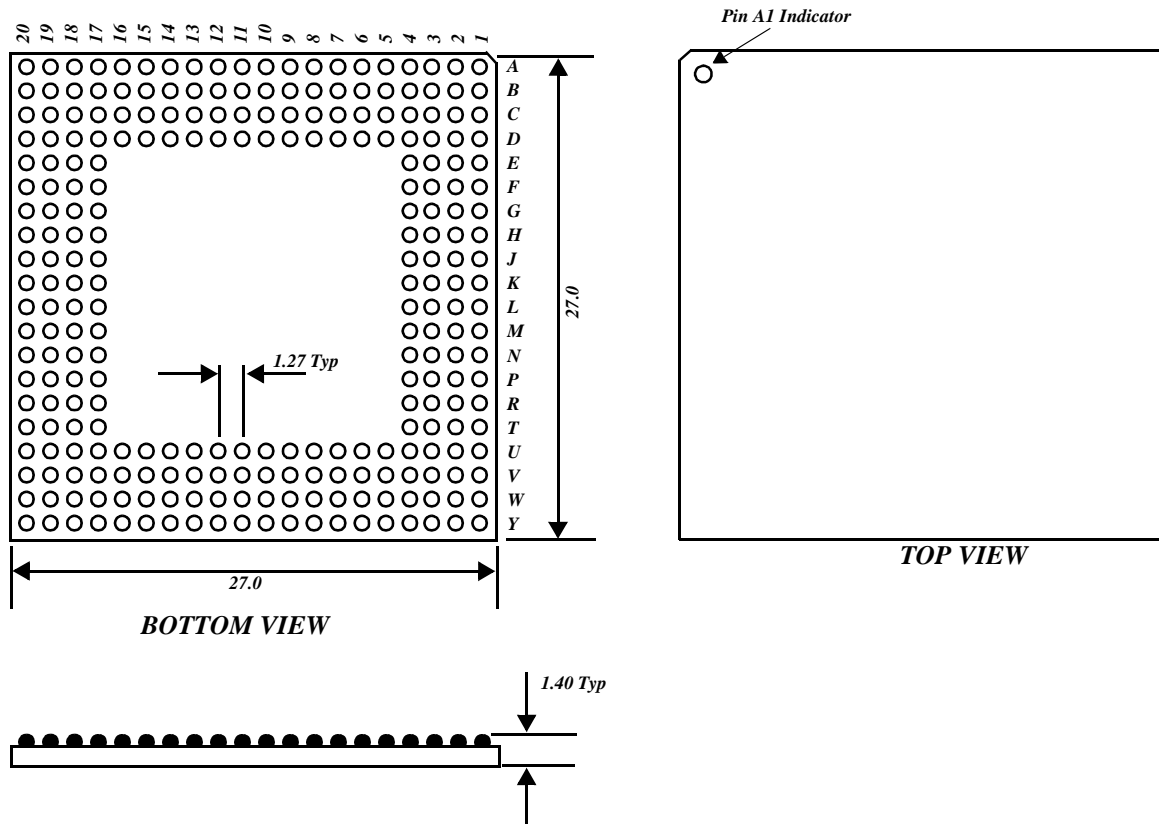

Package Thermal Considerations

The VSC7216-01 is packaged in a 256-pin, 27mm, thermally-enhanced BGA in a 20x20 array which offers excellent electrical characteristics, good thermal performance and small size. This package uses an industry-standard footprint. The package construction is shown in Figure 23.

Figure 23: Package Cross Section

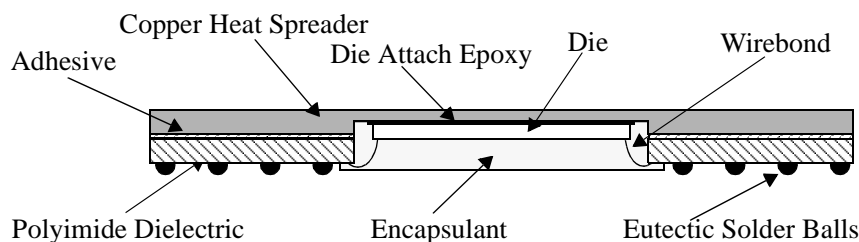

Table 19: Thermal Resistance

| Symbol | Description | Value | Units |
|-------------------|--|-------|-----------------------------|
| θ_{ca} | Thermal resistance from case-to-ambient in still air including conduction through the leads. | 15 | $^{\circ}\text{C}/\text{W}$ |
| θ_{ca-100} | Thermal resistance from case-to-ambient with 100 LFM airflow | 13 | $^{\circ}\text{C}/\text{W}$ |
| θ_{ca-200} | Thermal resistance from case-to-ambient with 200 LFM airflow | 12 | $^{\circ}\text{C}/\text{W}$ |
| θ_{ca-400} | Thermal resistance from case-to-ambient with 400 LFM airflow | 10.5 | $^{\circ}\text{C}/\text{W}$ |
| θ_{ca-600} | Thermal resistance from case-to-ambient with 600 LFM airflow | 10 | $^{\circ}\text{C}/\text{W}$ |

The VSC7216-01 is designed to operate with a case temperature up to 95°C . The user must guarantee that this case temperature specification is not violated. With the thermal resistances shown in Table 19, the VSC7216-01 can operate in still air ambient temperatures of 50°C [$50^{\circ}\text{C} = 95^{\circ}\text{C} - (3.0\text{W} \cdot 15^{\circ}\text{C}/\text{W})$]. If the ambient air temperature exceeds these limits, some form of cooling through a heat sink or an increase in airflow must be provided.

Moisture Sensitivity Level

This device is rated at with a Moisture Sensitivity Level 3 rating. Refer to Application Note AN-20 for appropriate handling procedures.

Preliminary Datasheet

VSC7216-01

Multi-Gigabit Interconnect Chip

Ordering Information

The part number for this product is formed by a combination of the device type and the package style:

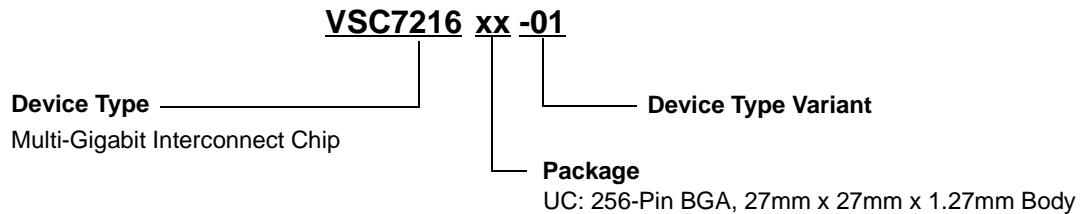

Marking Information

The package is marked with three lines of text as in Figure 24:

Figure 24: Package Marking Information

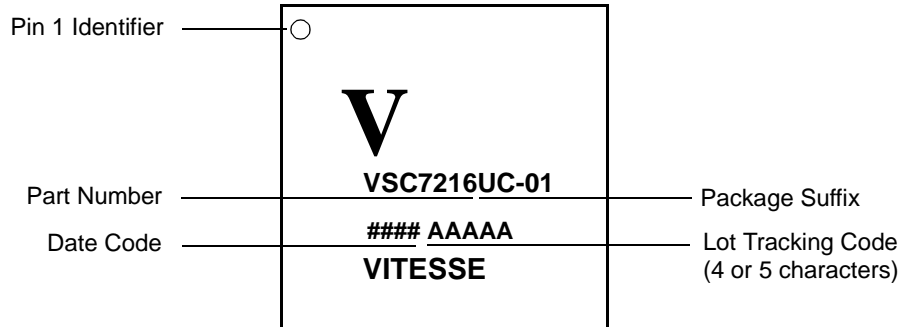

Notice

Vitesse Semiconductor Corporation (“Vitesse”) provides this document for informational purposes only. This document contains pre-production information about Vitesse products in their concept, development and/or testing phase. All information in this document, including descriptions of features, functions, performance, technical specifications and availability, is subject to change without notice at any time. Nothing contained in this document shall be construed as extending any warranty or promise, express or implied, that any Vitesse product will be available as described or will be suitable for or will accomplish any particular task.

Vitesse products are not intended for use in life support appliances, devices or systems. Use of a Vitesse product in such applications without written consent is prohibited.



Multi-Gigabit Interconnect Chip

This page left intentionally blank.