

September 1998

Features

- 4A, 120V and 150V
- $r_{DS(ON)} = 0.400\Omega$
- SOA is Power Dissipation Limited
- Nanosecond Switching Speeds
- Linear Transfer Characteristics
- High Input Impedance
- Majority Carrier Device

Ordering Information

PART NUMBER	PACKAGE	BRAND
RFL4N12	TO-205AF	RFL4N12
RFL4N15	TO-205AF	RFL4N15

NOTE: When ordering, use the entire part number.

Description

These are N-Channel enhancement mode silicon gate power field effect transistors designed for applications such as switching regulators, switching converters, motor drivers, relay drivers and drivers for high power bipolar switching transistors requiring high speed and low gate drive power. These types can be operated directly from integrated circuits.

Formerly developmental type TA9192.

Symbol

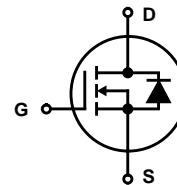

Packaging

JEDEC TO-205AF

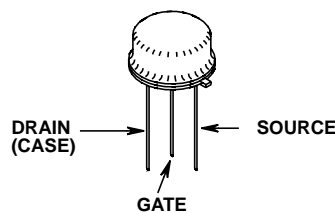

RFL4N12, RFL4N15

Absolute Maximum Ratings $T_C = 25^\circ\text{C}$, Unless Otherwise Specified

	RFL4N12	RFL4N15	UNITS	
Drain to Source Voltage (Note 1)	V_{DSS}	120	150	V
Drain to Gate Voltage ($R_{GS} = 1M\Omega$) (Note 1)	V_{DGR}	120	150	V
Continuous Drain Current	I_D	4	4	A
Pulsed Drain Current	I_{DM}	15	15	A
Gate to Source Voltage	V_{GS}	± 20	± 20	V
Maximum Power Dissipation	P_D	8.33	8.33	W
Linear Derating Factor		0.0667	0.0667	W/ $^\circ\text{C}$
Operating and Storage Temperature	T_J, T_{STG}	-55 to 150	-55 to 150	$^\circ\text{C}$
Maximum Temperature for Soldering Leads at 0.063in (1.6mm) from Case for 10s	T_L	260	260	$^\circ\text{C}$

CAUTION: Stresses above those listed in "Absolute Maximum Ratings" may cause permanent damage to the device. This is a stress only rating and operation of the device at these or any other conditions above those indicated in the operational sections of this specification is not implied.

NOTE:

- $T_J = 25^\circ\text{C}$ to 125°C .

Electrical Specifications $T_C = 25^\circ\text{C}$, Unless Otherwise Specified

PARAMETER	SYMBOL	TEST CONDITIONS	MIN	TYP	MAX	UNITS
Drain to Source Breakdown Voltage RFL4N12	BV_{DSS}	$I_D = 250\mu\text{A}, V_{GS} = 0\text{V}$	120	-	-	V
			150	-	-	V
RFL4N15						
Gate Threshold Voltage	$V_{GS(TH)}$	$V_{GS} = V_{DS}, I_D = 250\mu\text{A}$ (Figure 8)	2	-	4	V
Zero Gate Voltage Drain Current	I_{DSS}	$V_{DS} = \text{Rated } BV_{DSS}$	-	-	1	μA
		$V_{DS} = 0.8 \times \text{Rated } BV_{DSS}, T_C = 125^\circ\text{C}$	-	-	25	μA
Gate to Source Leakage Current	I_{GSS}	$V_{GS} = \pm 20\text{V}, V_{DS} = 0\text{V}$	-	-	± 100	nA
Drain to Source On-Voltage (Note 2)	$V_{DS(ON)}$	$I_D = 4\text{A}, V_{GS} = 10\text{V}$	-	-	1.6	V
Drain to Source On Resistance (Note 2)	$r_{DS(ON)}$	$I_D = 4\text{A}, V_{GS} = 10\text{V}$ (Figures 6, 7)	-	-	0.400	Ω
Turn-On Delay Time	$t_{d(ON)}$	$V_{DD} = 75\text{V}, I_D \approx 2\text{A}, R_G = 50\Omega, V_{GS} = 10\text{V}$ (Figures 10, 11, 12)	-	40	60	ns
Rise Time	t_r		-	165	250	ns
Turn-Off Delay Time	$t_{d(OFF)}$		-	90	135	ns
Fall Time	t_f		-	90	135	ns
Input Capacitance	C_{ISS}	$V_{DS} = 25\text{V}, V_{GS} = 0\text{V}, f = 1\text{MHz}$ (Figure 9)	-	-	850	pF
Output Capacitance	C_{OSS}		-	-	230	pF
Reverse-Transfer Capacitance	C_{RSS}		-	-	100	pF
Thermal Resistance Junction to Case	$R_{\theta JC}$		-	-	15	$^\circ\text{C/W}$

Source to Drain Diode Specifications

PARAMETER	SYMBOL	TEST CONDITIONS	MIN	TYP	MAX	UNITS
Source to Drain Diode Voltage (Note 2)	V_{SD}	$I_{SD} = 2\text{A}$			1.4	V
Reverse Recovery Time	t_{rr}	$I_{SD} = 2\text{A}, dI_{SD}/dt = 100\text{A}/\mu\text{s}$		200	-	ns

NOTE:

- Pulse Test: pulse duration $\leq 300\mu\text{s}$ max, duty cycle $\leq 2\%$.

Typical Performance Curves Unless Otherwise Specified

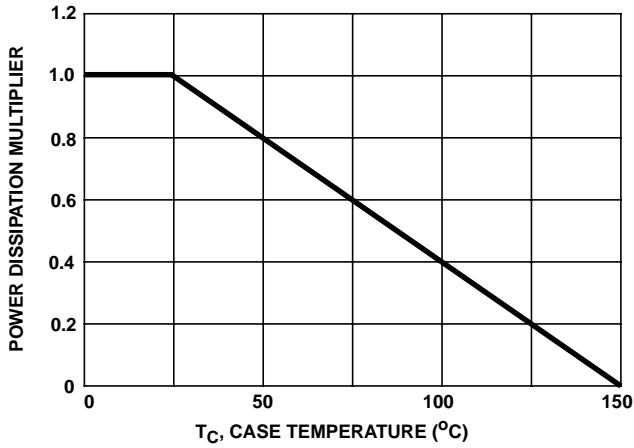

FIGURE 1. NORMALIZED POWER DISSIPATION vs CASE TEMPERATURE

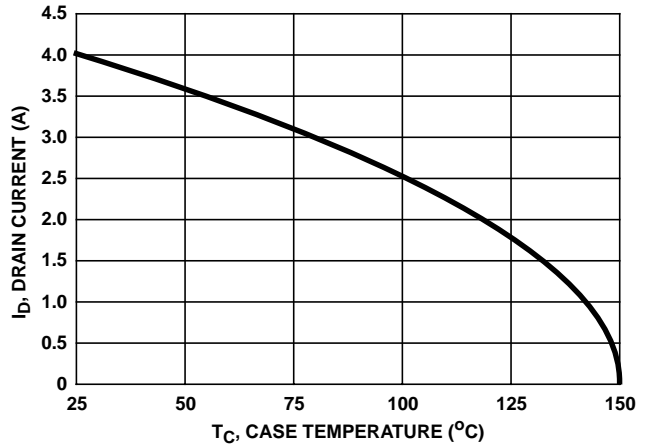

FIGURE 2. MAXIMUM CONTINUOUS DRAIN CURRENT vs CASE TEMPERATURE

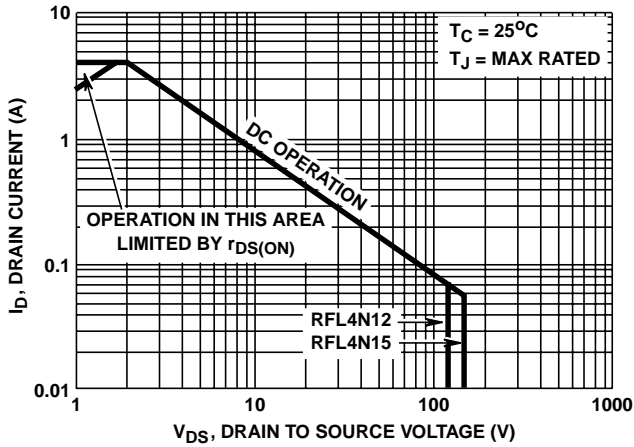

FIGURE 3. FORWARD BIAS SAFE OPERATING AREA

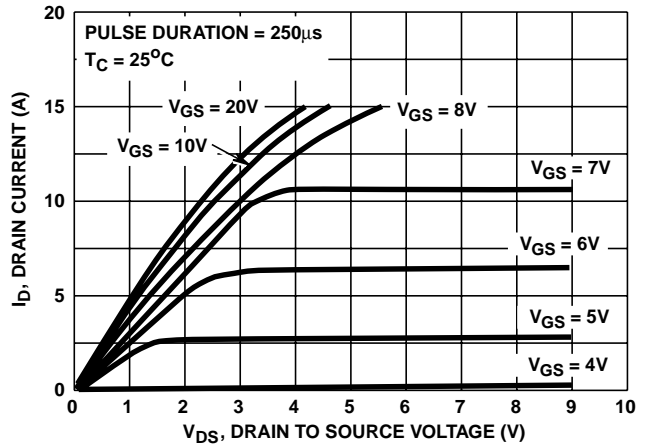

FIGURE 4. SATURATION CHARACTERISTICS

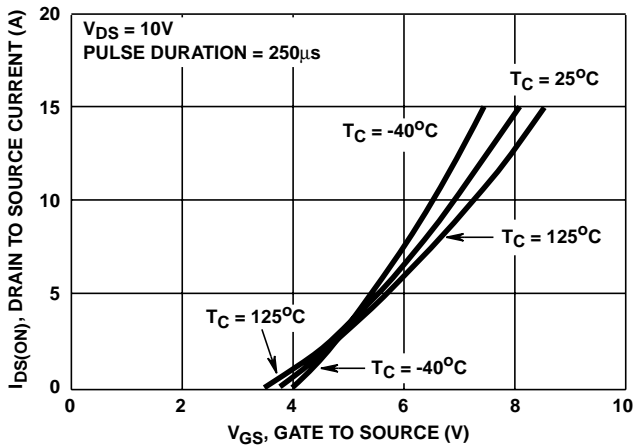

FIGURE 5. TRANSFER CHARACTERISTICS

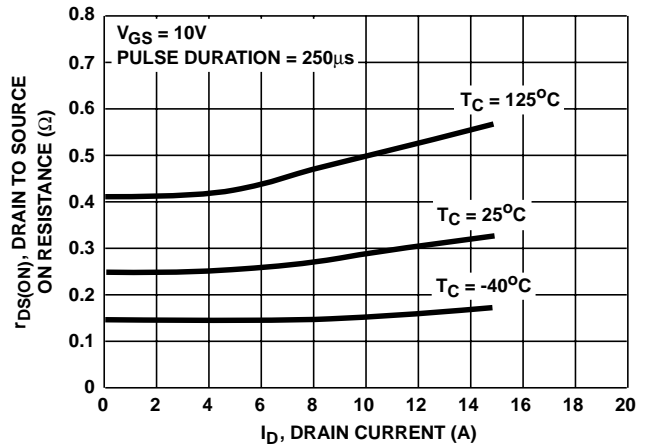

FIGURE 6. DRAIN TO SOURCE ON RESISTANCE vs DRAIN CURRENT

Typical Performance Curves Unless Otherwise Specified (Continued)

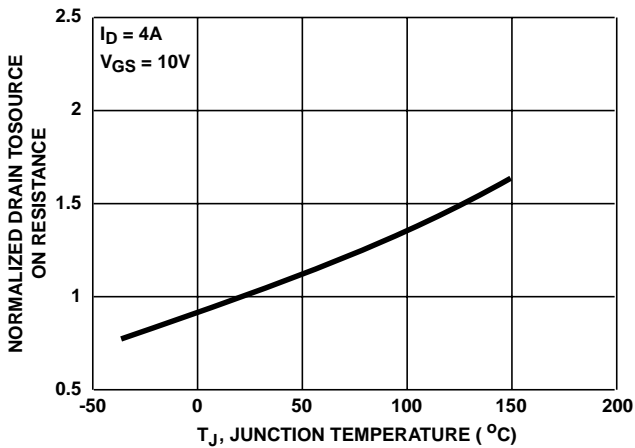

FIGURE 7. NORMALIZED DRAIN TO SOURCE ON RESISTANCE vs JUNCTION TEMPERATURE

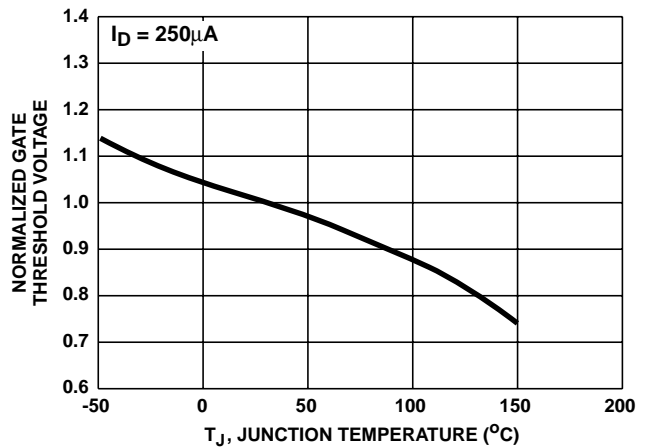

FIGURE 8. NORMALIZED GATE THRESHOLD VOLTAGE vs JUNCTION TEMPERATURE

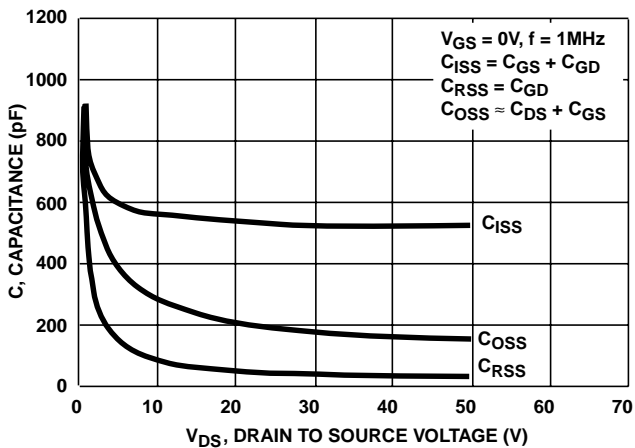
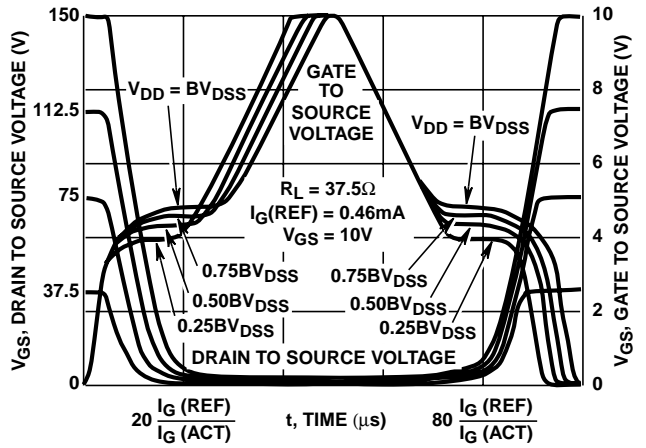

FIGURE 9. CAPACITANCE vs DRAIN TO SOURCE VOLTAGE



NOTE: Refer to Harris Application Notes AN7254 and AN7260.

FIGURE 10. NORMALIZED SWITCHING WAVEFORMS FOR CONSTANT GATE CURRENT

Test Circuits and Waveforms

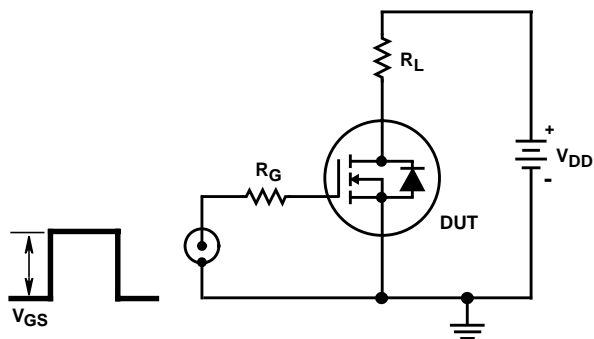

FIGURE 11. SWITCHING TIME TEST CIRCUIT

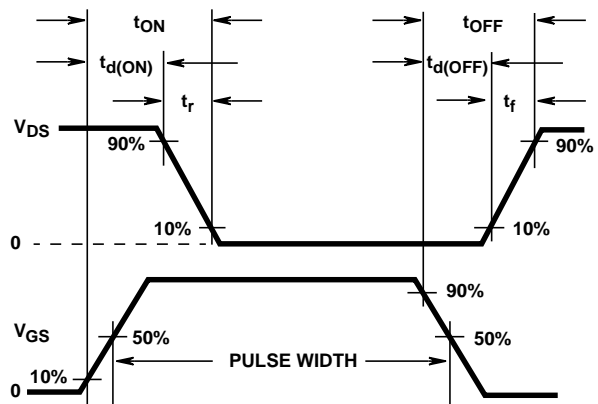

FIGURE 12. RESISTIVE SWITCHING WAVEFORMS