

Single SCR POW-R-BLOK™ Modules 400 Amperes/800 Volts

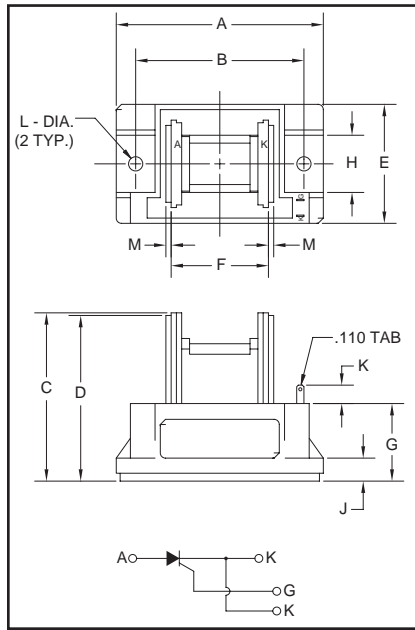

Outline Drawing

Dimension	Inches	Millimeters
A	3.15	80
B	2.559±0.012	65±0.3
C	2.56	65
D	2.52	64
E	1.81	46
F	1.48	36
G	1.18	30
H	0.87	22
J	0.35	9
K	0.28	7
L	0.216 Dia.	Dia. 5.5
M	0.08	2



CSD3080H
Single SCR
POW-R-BLOK™ Modules
400 Amperes/800 Volts

Description:

Powerex Single SCR POW-R-BLOK™ Modules are designed for use in applications requiring phase control and isolated packaging. The modules are isolated for easy mounting with other components on common heatsinks.

Features:

- Isolated Mounting
- Metal Baseplate
- Low Thermal Impedance

Applications:

- Solid State Starters
- By-Pass Switch
- AC and DC Motor Control

Ordering Information:

Select the complete eight digit module part number you desire from the table below.

Example: CSD3080H is an 800 Volt, 400 Ampere Single SCR POW-R-BLOK™ Module.

Type	Voltage Volts (x100)	Current Rating Amperes (400)
CSD3	08	0H



Powerex, Inc., 200 Hillis Street, Youngwood, Pennsylvania 15697-1800 (724) 925-7272

CSD3080H

Single SCR POW-R-BLOK™ Modules

400 Amperes/800 Volts

Absolute Maximum Ratings

Characteristics	Symbol	CSD3080H	Units
Peak Forward Blocking Voltage	V_{DRM}	800	Volts
Transient Peak Forward Blocking Voltage (Non-Repetitive) $t < 5ms$	V_{DSM}	960	Volts
DC Forward Blocking Voltage	$V_{D(DC)}$	640	Volts
Peak Reverse Blocking Voltage	V_{RRM}	800	Volts
Transient Peak Reverse Blocking Voltage (Non-Repetitive), $t < 5ms$	V_{RSM}	960	Volts
DC Reverse Blocking Voltage	$V_{R(DC)}$	640	Volts
RMS On-State Current	$I_T(RMS)$	620	Amperes
Average On-State Current, $T_C = 66^\circ C$	$I_T(AV)$	400	Amperes
Peak One-Cycle Surge (Non-Repetitive) On-State Current (60Hz)	I_{TSM}	8000	Amperes
Peak One-Cycle Surge (Non-Repetitive) On-State Current (50Hz)	I_{TSM}	7300	Amperes
I^2t (for Fusing), 8.3 milliseconds	I^2t	267,000	A ² sec
Critical Rate-Of-Rise of On-State Current*	di/dt	100	Amperes/ μs
Peak Gate Power Dissipation	P_{GM}	10	Watts
Average Gate Power Dissipation	$P_{G(AV)}$	3	Watts
Peak Forward Gate Voltage	V_{GFM}	10	Volts
Peak Reverse Gate Voltage	V_{GRM}	5.0	Volts
Peak Forward Gate Current	I_{GFM}	4.0	Amperes
Storage Temperature	T_{STG}	-40 to 125	°C
Operating Temperature	T_j	-40 to 125	°C
Maximum Mounting Torque M5 Mounting Screw	—	17	in.-lb.
Maximum Mounting Torque M8 Terminal Screw	—	72	in.-lb.
Module Weight (Typical)	—	450	Grams
V Isolation	V_{RMS}	2500	Volts

* $T_j = 125^\circ C$, $I_G = 1.0A$, $V_D = 1/2 V_{DRM}$

CSD3080H
Single SCR POW-R-BLOK™ Modules
 400 Amperes/800 Volts

Electrical and Thermal Characteristics, $T_j = 25^\circ\text{C}$ unless otherwise specified

Characteristics	Symbol	Test Conditions	CSD3080H	Units
Blocking State Maximums				
Forward Leakage Current, Peak	I_{DRM}	$T_j = 125^\circ\text{C}$, $V_{\text{DRM}} = \text{Rated}$	40	mA
Reverse Leakage Current, Peak	I_{RRM}	$T_j = 125^\circ\text{C}$, $V_{\text{RRM}} = \text{Rated}$	40	mA
Conducting State Maximums				
Peak On-State Voltage	V_{TM}	$I_{\text{TM}} = 1200\text{A}$	1.4	Volts
Switching Minimums				
Critical Rate-Of-Rise	dv/dt	$T_j = 125^\circ\text{C}$, $V_{\text{D}} = 2/3 V_{\text{DRM}}$	500	Volts/ μs
Thermal Maximums				
Thermal Resistance, Junction-to-Case	$R_{\theta(\text{J-C})}$	Per Module	0.1	$^\circ\text{C}/\text{Watt}$
Thermal Resistance, Case-to-Sink (Lubricated)	$R_{\theta(\text{C-S})}$	Per Module	0.08	$^\circ\text{C}/\text{Watt}$
Gate Parameters Maximums				
Gate Current to Trigger	I_{GT}	$V_{\text{D}} = 6\text{V}$, $R_{\text{L}} = 2\Omega$	100	mA
Gate Voltage to Trigger	V_{GT}	$V_{\text{D}} = 6\text{V}$, $R_{\text{L}} = 2\Omega$	3.0	Volts
Non-Triggering Gate Voltage	V_{GDM}	$T_j = 125^\circ\text{C}$, $V_{\text{D}} = 1/2 V_{\text{DRM}}$	0.25	Volts

CSD3080H
Single SCR POW-R-BLOK™ Modules
 400 Amperes/800 Volts

MAXIMUM ON-STATE CHARACTERISTICS

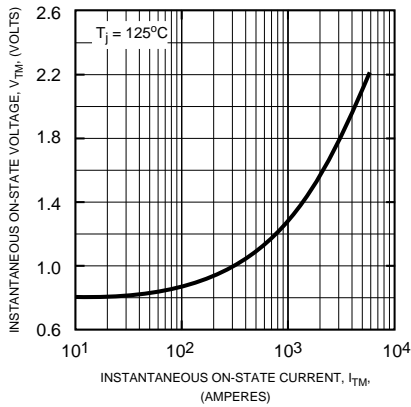

MAXIMUM ALLOWABLE PEAK SURGE (NON-REPETITIVE) CURRENT

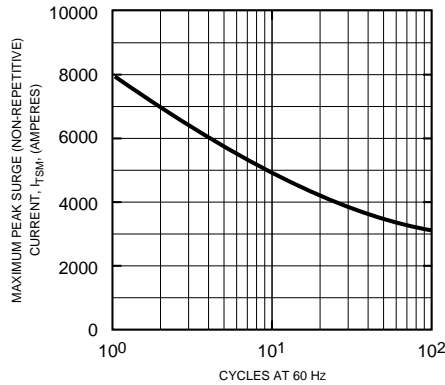

TRIGGERING CHARACTERISTICS

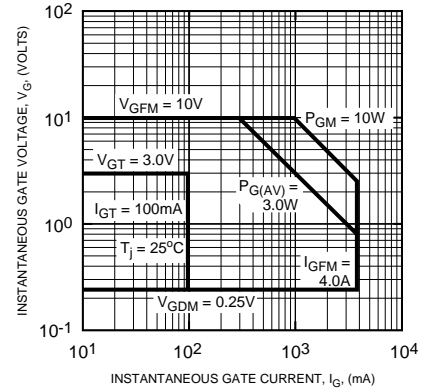

TRANSIENT THERMAL IMPEDANCE CHARACTERISTICS (JUNCTION-TO-CASE)

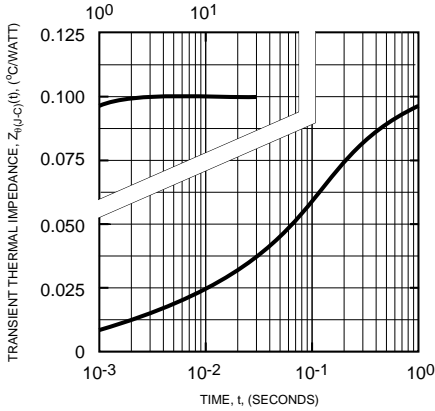

MAXIMUM ON-STATE POWER DISSIPATION (SINUSOIDAL WAVEFORM)

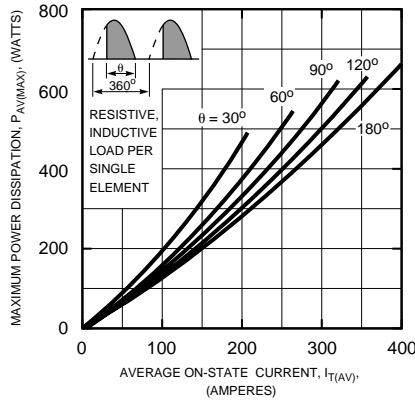

MAXIMUM ALLOWABLE CASE TEMPERATURE (SINUSOIDAL WAVEFORM)

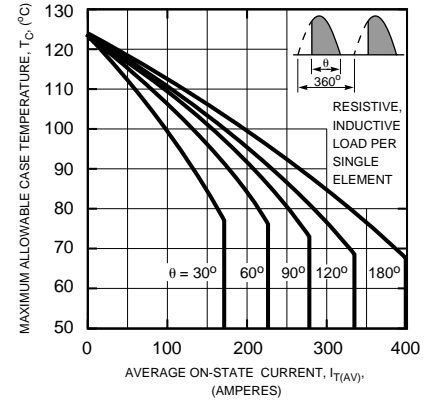

MAXIMUM AVERAGE ON-STATE POWER DISSIPATION (RECTANGULAR WAVEFORM)

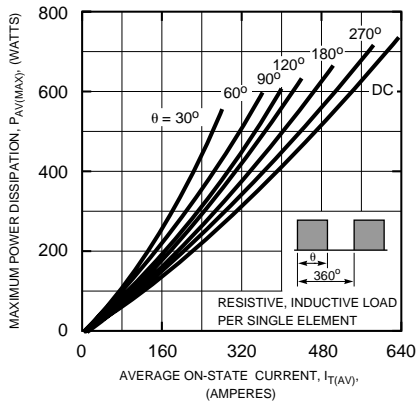

MAXIMUM ALLOWABLE CASE TEMPERATURE (RECTANGULAR WAVEFORM)

