

**Description**

The GM71V(S)17400B/BL is the new generation dynamic RAM organized 4,194,304 words x 4 Bit. GM71V(S)17400B/BL has realized higher density, higher performance and various functions by utilizing advanced CMOS process technology. The GM71V(S)17400B/BL offers Fast Page Mode as a high speed access mode. Multiplexed address inputs permit the GM71V(S)17400B/BL to be packaged in a standard 300 mil 24 (26) pin SOJ and standard 300mil 24(26)pin plastic TSOP II. The package size provides high system bit densities and is compatible with widely available automated testing and insertion equipment. System oriented features include single power supply 3.3V ± 0.3V tolerance, direct interfacing capability with high performance logic families such as Schottky TTL.

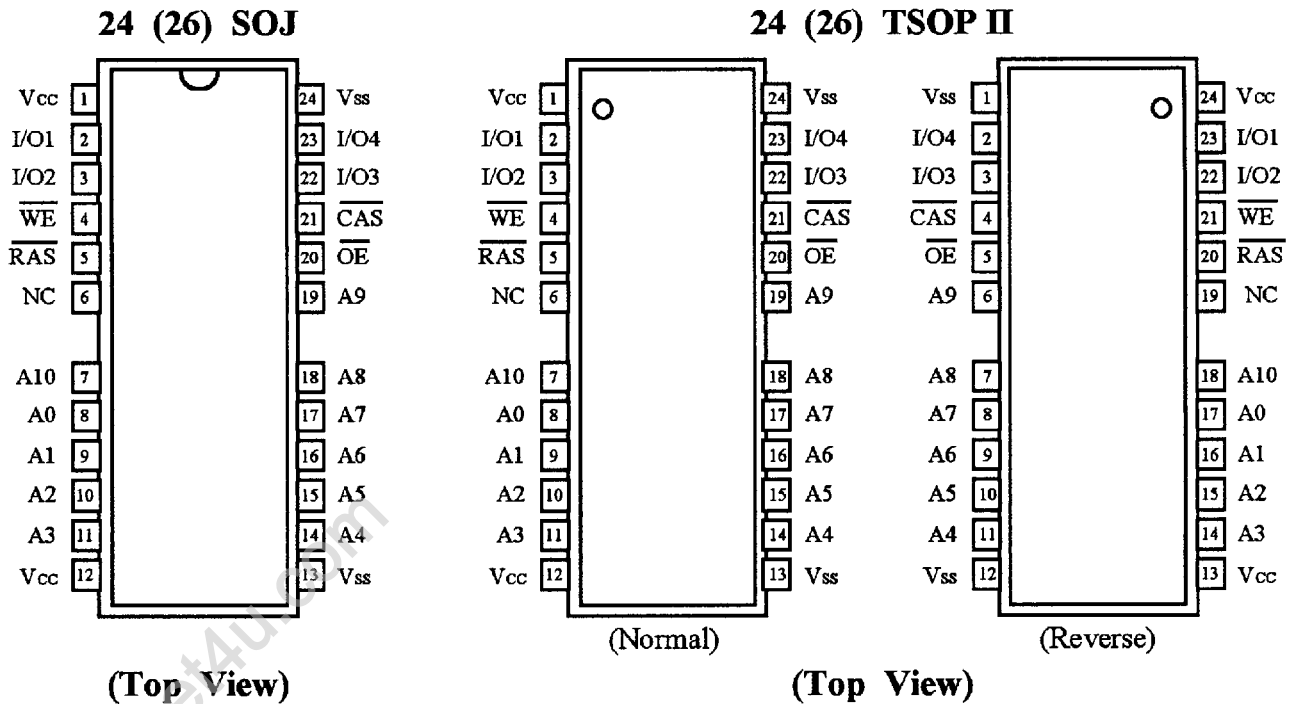
**Features**

- 4,194,304 Words x 4 Bit
- Fast Page Mode Capability
- Single Power Supply (3.3V ± 0.3V)
- Fast Access Time & Cycle Time (Unit: ns)

	t <sub>rac</sub>	t <sub>cac</sub>	t <sub>rc</sub>	t <sub>pc</sub>
GM71V(S)17400B/BL-6	60	15	110	40
GM71V(S)17400B/BL-7	70	18	130	45
GM71V(S)17400B/BL-8	80	20	150	50

- Low Power  
Active : 369/360/324mW (MAX)  
Standby : 3.6mW (CMOS level : MAX)  
0.36mW (L-version : MAX)
- $\overline{\text{RAS}}$  Only Refresh,  $\overline{\text{CAS}}$  before  $\overline{\text{RAS}}$  Refresh, Hidden Refresh Capability
- All inputs and outputs TTL Compatible
- 2048 Refresh Cycles/32ms
- 2048 Refresh Cycles/128ms (L-version)
- Battery Back Up Operation (L-version)
- Self Refresh Operation (L-version)
- Test function : 16-bit parallel test mode

**Pin Configuration**



**Pin Description**

Pin	Function	Pin	Function
A0-A10	Address Inputs	$\overline{WE}$	Read/Write Enable
A0-A10	Refresh Address Inputs	$\overline{OE}$	Output Enable
I/O1-I/O4	Data Input/Data Output	V <sub>CC</sub>	Power (+3.3V)
$\overline{RAS}$	Row Address Strobe	V <sub>SS</sub>	Ground
$\overline{CAS}$	Column Address Strobe	NC	No Connection

**Ordering Information**

Type No.	Access Time	Package
GM71V(S)17400BJ/BLJ-6 GM71V(S)17400BJ/BLJ-7 GM71V(S)17400BJ/BLJ-8	60 ns 70 ns 80 ns	300 Mil 24 (26) Pin Plastic SOJ
GM71V(S)17400BT/BLT-6 GM71V(S)17400BT/BLT-7 GM71V(S)17400BT/BLT-8	60 ns 70 ns 80 ns	300 Mil 24 (26) Pin Plastic TSOP II (Normal Type)
GM71V(S)17400BR/BLR-6 GM71V(S)17400BR/BLR-7 GM71V(S)17400BR/BLR-8	60 ns 70 ns 80 ns	300 Mil 24 (26) Pin Plastic TSOP II (Reverse Type)

**Absolute Maximum Ratings\***

Symbol	Parameter	Rating	Unit
T <sub>A</sub>	Ambient Temperature under Bias	0 ~ 70	°C
T <sub>STG</sub>	Storage Temperature (Plastic)	-55 ~ 125	°C
V <sub>IN</sub> /V <sub>OUT</sub>	Voltage on any Pin Relative to V <sub>SS</sub>	-0.5 ~ V <sub>CC</sub> +0.5 (≤4.6 V(MAX))	V
V <sub>CC</sub>	Voltage on V <sub>CC</sub> Relative to V <sub>SS</sub>	-0.5 ~ +4.6	V
I <sub>OUT</sub>	Short Circuit Output Current	50	mA
P <sub>D</sub>	Power Dissipation	1.0	W

\*Note: Operation at or above Absolute Maximum Ratings can adversely affect device reliability.

**Recommended DC Operating Conditions (T<sub>A</sub> = 0 ~ 70°C)**

Symbol	Parameter	Min	Typ	Max	Unit
V <sub>CC</sub>	Supply Voltage	3.0	3.3	3.6	V
V <sub>IH</sub>	Input High Voltage	2.0	-	V <sub>CC</sub> +0.3	V
V <sub>IL</sub>	Input Low Voltage	-0.3	-	0.8	V

**DC Electrical Characteristics** ( $V_{CC} = 3.3V \pm 0.3V$ ,  $V_{SS} = 0V$ ,  $T_A = 0 \sim 70^\circ C$ )

Symbol	Parameter	Min	Max	Unit	Note	
$V_{OH}$	Output Level Output "H" Level Voltage ( $I_{OUT} = -2mA$ )	2.4	$V_{CC}$	V		
$V_{OL}$	Output Level Output "L" Level Voltage ( $I_{OUT} = 2mA$ )	0	0.4	V		
$I_{CC1}$	Operating Current Average Power Supply Operating Current ( $\overline{RAS}$ , $\overline{CAS}$ Cycling: $t_{RC} = t_{RC\ min}$ )	60 ns	-	110	mA	1, 2
		70 ns	-	100		
		80 ns	-	90		
$I_{CC2}$	Standby Current (TTL) Power Supply Standby Current ( $\overline{RAS}$ , $\overline{CAS} = V_{IH}$ , $D_{OUT} = High-Z$ )	-	2	mA		
$I_{CC3}$	$\overline{RAS}$ Only Refresh Current Average Power Supply Current $\overline{RAS}$ Only Refresh Mode ( $t_{RC} = t_{RC\ min}$ )	60 ns	-	110	mA	2
		70 ns	-	100		
		80 ns	-	90		
$I_{CC4}$	Fast Page Mode Current Average Power Supply Current Fast Page Mode ( $t_{RC} = t_{RC\ min}$ )	60 ns	-	80	mA	1, 3
		70 ns	-	70		
		80 ns	-	65		
$I_{CC5}$	Standby Current (CMOS) Power Supply Standby Current ( $\overline{RAS}$ , $\overline{CAS} \geq V_{CC} - 0.2V$ , $D_{OUT} = High-Z$ )	-	1	mA	5	
		-	100	$\mu A$		
$I_{CC6}$	$\overline{CAS}$ -before- $\overline{RAS}$ Refresh Current ( $t_{RC} = t_{RC\ min}$ )	60 ns	-	110	mA	
		70 ns	-	100		
		80 ns	-	90		
$I_{CC7}$	Standby Current $\overline{RAS} = V_{IH}$ $CAS = V_{IL}$ $D_{OUT} = Enable$	-	5	mA	1	
$I_{CC8}$	Battery Back Up Operating Current(C-MOS) (Standby with CBR Refresh) ( $t_{RC}=62.5\ \mu s$ , $t_{RAS} \leq 0.3\ \mu s$ , $D_{OUT}=High-Z$ )	-	300	$\mu A$	4,5	
$I_{CC9}$	Self-Refresh Mode Current ( $\overline{RAS}$ , $\overline{CAS} \leq 0.2V$ , $D_{OUT}=High-Z$ )	-	200	$\mu A$	5	
$I_{L(O)}$	Input Leakage Current Any Input ( $0V \leq V_{IN} \leq 4.6V$ )	-10	10	$\mu A$		
$I_{L(O)}$	Output Leakage Current ( $D_{OUT}$ is Disabled, $0V \leq V_{OUT} \leq 4.6V$ )	-10	10	$\mu A$		

Note: 1.  $I_{CC}$  depends on output load condition when the device is selected.  $I_{CC(max)}$  is specified at the output open condition.

2. Address can be changed once or less while  $\overline{RAS} = V_{IL}$ .

3. Address can be changed once or less while  $\overline{CAS} = V_{IH}$ .

4.  $\overline{CAS} = L (\leq 0.2V)$  while  $\overline{RAS} = L (\leq 0.2V)$ .

5. L-version.

**Capacitance** ( $V_{CC} = 3.3V \pm 0.3V$ ,  $T_A = 25^\circ C$ )

Symbol	Parameter	Min	Max	Unit	Note
$C_{I1}$	Input Capacitance (Address)	-	5	pF	1
$C_{I2}$	Input Capacitance (Clocks)	-	7	pF	1
$C_{I/O}$	Output Capacitance (Data-In/Out)	-	7	pF	1, 2

Note: 1. Capacitance measured with Boonton Meter or effective capacitance measuring method.  
 2.  $\overline{CAS}$  =  $V_{IH}$  to disable  $D_{out}$ .

**AC Characteristics** ( $V_{CC} = 3.3V \pm 0.3V$ ,  $T_A = 0 \sim 70^\circ C$ , Notes 1, 2, 18, 19)

**Test Conditions**

Input rise and fall times : 2 ns

Output timing reference levels : 0.8V, 2.0V

Input timing reference levels : 0.8V, 2.0V

 Output load : 1TTL gate +  $C_L$  (100 pF)

(Including scope and jig)

**Read, Write, Read-Modify-Write and Refresh Cycles (Common Parameters)**

Symbol	Parameter	GM71V(S)17400 B/BL-6		GM71V(S)17400 B/BL-7		GM71V(S)17400 B/BL-8		Unit	Note
		Min	Max	Min	Max	Min	Max		
$t_{RC}$	Random Read or Write Cycle Time	110	-	130	-	150	-	ns	
$t_{RP}$	$\overline{RAS}$ Precharge Time	40	-	50	-	60	-	ns	
$t_{CP}$	$\overline{CAS}$ Precharge Time	10	-	10	-	10	-	ns	
$t_{RAS}$	$\overline{RAS}$ Pulse Width	60	10,000	70	10,000	80	10,000	ns	
$t_{CAS}$	$\overline{CAS}$ Pulse Width	15	10,000	18	10,000	20	10,000	ns	
$t_{ASR}$	Row Address Setup Time	0	-	0	-	0	-	ns	
$t_{RAH}$	Row Address Hold Time	10	-	10	-	10	-	ns	
$t_{ASC}$	Column Address Setup Time	0	-	0	-	0	-	ns	
$t_{CAH}$	Column Address Hold Time	10	-	15	-	15	-	ns	
$t_{RCD}$	$\overline{RAS}$ to $\overline{CAS}$ Delay Time	20	45	20	52	20	60	ns	3
$t_{RAD}$	$\overline{RAS}$ to Column Address Delay Time	15	30	15	35	15	40	ns	4
$t_{RSH}$	$\overline{RAS}$ Hold Time	15	-	18	-	20	-	ns	
$t_{CSH}$	$\overline{CAS}$ Hold Time	60	-	70	-	80	-	ns	
$t_{CRP}$	$\overline{CAS}$ to $\overline{RAS}$ Precharge Time	5	-	5	-	5	-	ns	
$t_{ODD}$	$\overline{OE}$ to $D_{IN}$ Delay Time	15	-	18	-	20	-	ns	5
$t_{DZO}$	$\overline{OE}$ Delay Time from $D_{IN}$	0	-	0	-	0	-	ns	6
$t_{DZC}$	$\overline{CAS}$ Set-up Time from $D_{IN}$	0	-	0	-	0	-	ns	6
$t_T$	Transition Time (Rise and Fall)	3	50	3	50	3	50	ns	7
$t_{REF}$	Refresh Period	-	32	-	32	-	32	ms	
	Refresh Period (L-version)	-	128	-	128	-	128	ms	

**Read Cycle**

Symbol	Parameter	GM71V(S)17400 B/BL-6		GM71V(S)17400 B/BL-7		GM71V(S)17400 B/BL-8		Unit	Note
		Min	Max	Min	Max	Min	Max		
t <sub>RAC</sub>	Access Time from $\overline{\text{RAS}}$	-	60	-	70	-	80	ns	8.9,20
t <sub>CAC</sub>	Access Time from $\overline{\text{CAS}}$	-	15	-	18	-	20	ns	9,10, 17,20
t <sub>AA</sub>	Access Time from Column Address	-	30	-	35	-	40	ns	9,11, 17,20
t <sub>OAC</sub>	Access Time from $\overline{\text{OE}}$	-	15	-	18	-	20	ns	9,20
t <sub>RCS</sub>	Read Command Setup Time	0	-	0	-	0	-	ns	
t <sub>RCH</sub>	Read Command Hold Time to $\overline{\text{CAS}}$	0	-	0	-	0	-	ns	12
t <sub>RRH</sub>	Read Command Hold Time to $\overline{\text{RAS}}$	0	-	0	-	0	-	ns	12
t <sub>RAL</sub>	Column Address to $\overline{\text{RAS}}$ Lead Time	30	-	35	-	40	-	ns	
t <sub>CAL</sub>	Column Address to $\overline{\text{CAS}}$ Lead Time	30	-	35	-	40	-	ns	
t <sub>CLZ</sub>	$\overline{\text{CAS}}$ to Output in low-Z	0	-	0	-	0	-	ns	
t <sub>OH</sub>	Output Data Hold Time	3	-	3	-	3	-	ns	
t <sub>OH0</sub>	Output Data Hold Time from $\overline{\text{OE}}$	3	-	3	-	3	-	ns	
t <sub>OEZ</sub>	Output Buffer Turn-off Time to $\overline{\text{OE}}$	-	15	-	18	-	20	ns	13
t <sub>OFF</sub>	Output Buffer Turn-off Time	-	15	-	15	-	15	ns	13
t <sub>CDD</sub>	$\overline{\text{CAS}}$ to $\overline{\text{DIN}}$ Delay Time	15	-	18	-	20	-	ns	5

**Write Cycle**

Symbol	Parameter	GM71V(S)17400 B/BL-6		GM71V(S)17400 B/BL-7		GM71V(S)17400 B/BL-8		Unit	Note
		Min	Max	Min	Max	Min	Max		
t <sub>WCS</sub>	Write Command Setup Time	0	-	0	-	0	-	ns	14
t <sub>WCH</sub>	Write Command Hold Time	10	-	15	-	15	-	ns	
t <sub>WP</sub>	Write Command Pulse Width	10	-	10	-	10	-	ns	
t <sub>RWL</sub>	Write Command to $\overline{\text{RAS}}$ Lead Time	15	-	18	-	20	-	ns	
t <sub>CWL</sub>	Write Command to $\overline{\text{CAS}}$ Lead Time	15	-	18	-	20	-	ns	
t <sub>DS</sub>	Data-in Setup Time	0	-	0	-	0	-	ns	15
t <sub>DH</sub>	Data-in Hold Time	10	-	15	-	15	-	ns	15

### Read-Modify-Write Cycle

Symbol	Parameter	GM71V(S)17400 B/BL-6		GM71V(S)17400 B/BL-7		GM71V(S)17400 B/BL-8		Unit	Note
		Min	Max	Min	Max	Min	Max		
t <sub>RWC</sub>	Read-Modify-Write Cycle Time	155	-	181	-	205	-	ns	
t <sub>RWD</sub>	$\overline{\text{RAS}}$ to $\overline{\text{WE}}$ Delay Time	85	-	98	-	110	-	ns	14
t <sub>CWD</sub>	$\overline{\text{CAS}}$ to $\overline{\text{WE}}$ Delay Time	40	-	46	-	50	-	ns	14
t <sub>AWD</sub>	Column Address to $\overline{\text{WE}}$ Delay Time	55	-	63	-	70	-	ns	14
t <sub>OEH</sub>	$\overline{\text{OE}}$ Hold Time from $\overline{\text{WE}}$	15	-	18	-	20	-	ns	

### Refresh Cycle

Symbol	Parameter	GM71V(S)17400 B/BL-6		GM71V(S)17400 B/BL-7		GM71V(S)17400 B/BL-8		Unit	Note
		Min	Max	Min	Max	Min	Max		
t <sub>CSR</sub>	$\overline{\text{CAS}}$ Set-up Time ( $\overline{\text{CAS}}$ -before- $\overline{\text{RAS}}$ Refresh Cycle)	5	-	5	-	5	-	ns	
t <sub>CHR</sub>	$\overline{\text{CAS}}$ Hold Time ( $\overline{\text{CAS}}$ -before- $\overline{\text{RAS}}$ Refresh Cycle)	10	-	10	-	10	-	ns	
t <sub>RPC</sub>	$\overline{\text{RAS}}$ Precharge to $\overline{\text{CAS}}$ Hold Time	0	-	0	-	0	-	ns	
t <sub>WRP</sub>	$\overline{\text{WE}}$ Set-up Time ( $\overline{\text{CAS}}$ -before- $\overline{\text{RAS}}$ Refresh Cycle)	0	-	0	-	0	-	ns	
t <sub>WRH</sub>	$\overline{\text{WE}}$ Hold Time ( $\overline{\text{CAS}}$ -before- $\overline{\text{RAS}}$ Refresh Cycle)	10	-	10	-	10	-	ns	

### Fast Page Mode Cycle

Symbol	Parameter	GM71V(S)17400 B/BL-6		GM71V(S)17400 B/BL-7		GM71V(S)17400 B/BL-8		Unit	Note
		Min	Max	Min	Max	Min	Max		
t <sub>PC</sub>	Fast Page Mode Cycle Time	40	-	45	-	50	-	ns	
t <sub>RASP</sub>	Fast Page Mode $\overline{\text{RAS}}$ Pulse Width	-	100,000	-	100,000	-	100,000	ns	16
t <sub>ACP</sub>	Access Time from $\overline{\text{CAS}}$ Precharge	-	35	-	40	-	45	ns	9,17,20
t <sub>RHCP</sub>	$\overline{\text{RAS}}$ Hold Time from $\overline{\text{CAS}}$ Precharge	35	-	40	-	45	-	ns	
t <sub>CPW</sub>	$\overline{\text{WE}}$ Delay Time from $\overline{\text{CAS}}$ Precharge	60	-	68	-	75	-	ns	14
t <sub>PRWC</sub>	Fast Page Mode Read-Modify-Write Cycle Time	85	-	96	-	105	-	ns	

**Test Mode Cycle <sup>\*20</sup>**

Symbol	Parameter	GM71V(S)17400 B/BL-6		GM71V(S)17400 B/BL-7		GM71V(S)17400 B/BL-8		Unit	Note
		Min	Max	Min	Max	Min	Max		
t <sub>WTS</sub>	Test Mode $\overline{WE}$ Setup Time	0	-	0	-	0	-	ns	
t <sub>WTH</sub>	Test Mode $\overline{WE}$ Hold Time	10	-	10	-	10	-	ns	

**Counter Test Cycle**

Symbol	Parameter	GM71V(S)17400 B/BL-6		GM71V(S)17400 B/BL-7		GM71V(S)17400 B/BL-8		Unit	Note
		Min	Max	Min	Max	Min	Max		
t <sub>CPT</sub>	$\overline{CAS}$ Precharge Time in Counter Test Cycle	20	-	30	-	30	-	ns	

**Self Refresh Mode (L-Version)**

Symbol	Parameter	GM71VS17400 BL-6		GM71VS17400 BL-7		GM71VS17400 BL-8		Unit	Note
		Min	Max	Min	Max	Min	Max		
t <sub>RASS</sub>	$\overline{RAS}$ Pulse Width (Self-Refresh)	100	-	100	-	100	-	us	
t <sub>RPS</sub>	$\overline{RAS}$ Precharge Time (Self-Refresh)	110	-	130	-	150	-	ns	
t <sub>CHS</sub>	$\overline{CAS}$ Hold Time (Self-Refresh)	-50	-	-50	-	-50	-	ns	



## Notes:

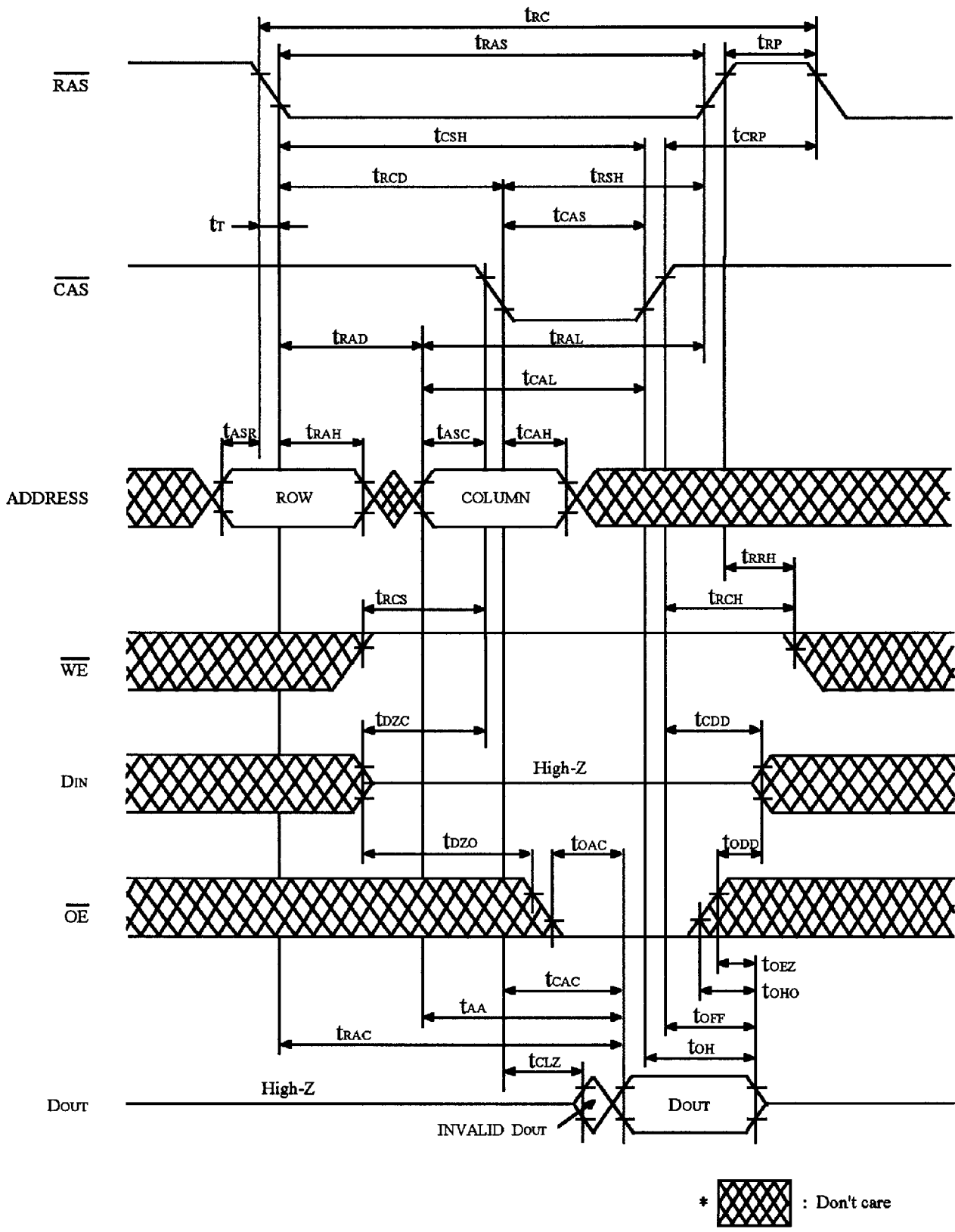
1. AC Measurements assume  $t_r = 5\text{ ns}$ .
2. An initial pause of  $200\ \mu\text{s}$  is required after power up followed by a minimum of eight initialization cycles (any combination of cycles containing RAS-only refresh or CAS-before-RAS refresh). If the internal refresh counter is used, a minimum of eight CAS-before-RAS refresh cycles are required.
3. Operation with the  $t_{\text{rCD}}(\text{max})$  limit insures that  $t_{\text{rAC}}(\text{max})$  can be met,  $t_{\text{rCD}}(\text{max})$  is specified as a reference point only; if  $t_{\text{rCD}}$  is greater than the specified  $t_{\text{rCD}}(\text{max})$  limit, then access time is controlled exclusively by  $t_{\text{CAC}}$ .
4. Operation with the  $t_{\text{rAD}}(\text{max})$  limit insures that  $t_{\text{rAC}}(\text{max})$  can be met,  $t_{\text{rAD}}(\text{max})$  is specified as a reference point only; if  $t_{\text{rAD}}$  is greater than the specified  $t_{\text{rAD}}(\text{max})$  limit, then access time is controlled exclusively by  $t_{\text{AA}}$ .
5. Either  $t_{\text{ODD}}$  or  $t_{\text{CDD}}$  must be satisfied.
6. Either  $t_{\text{DZO}}$  or  $t_{\text{DZC}}$  must be satisfied.
7.  $V_{\text{IH}}(\text{min})$  and  $V_{\text{IL}}(\text{max})$  are reference levels for measuring timing of input signals. Also, transition times are measured between  $V_{\text{IH}}(\text{min})$  and  $V_{\text{IL}}(\text{max})$ .
8. Assume that  $t_{\text{rCD}} \leq t_{\text{rCD}}(\text{max})$  and  $t_{\text{rAD}} \leq t_{\text{rAD}}(\text{max})$ . If  $t_{\text{rCD}}$  or  $t_{\text{rAD}}$  is greater than the maximum recommended value shown in this table,  $t_{\text{rAC}}$  exceeds the value shown.
9. Measured with a load circuit equivalent to 1 TTL loads and  $100\text{ pF}$ .
10. Assume that  $t_{\text{rCD}} \geq t_{\text{rCD}}(\text{max})$  and  $t_{\text{rAD}} \leq t_{\text{rAD}}(\text{max})$ .
11. Assume that  $t_{\text{rCD}} \leq t_{\text{rCD}}(\text{max})$  and  $t_{\text{rAD}} \geq t_{\text{rAD}}(\text{max})$ .
12. Either  $t_{\text{rCH}}$  or  $t_{\text{rRH}}$  must be satisfied for a read cycles.
13.  $t_{\text{OFF}}(\text{max})$  and  $t_{\text{OEZ}}(\text{max})$  define the time at which the outputs achieve the open circuit condition and are not referenced to output voltage levels.
14.  $t_{\text{WCS}}$ ,  $t_{\text{rWD}}$ ,  $t_{\text{CWD}}$ ,  $t_{\text{AWD}}$  and  $t_{\text{CPW}}$  are not restrictive operating parameters. They are included in the data sheet as electrical characteristics only; if  $t_{\text{WCS}} \geq t_{\text{WCS}}(\text{min})$ , the cycle is an early write cycle and the data out pin will remain open circuit (high impedance) throughout the entire cycle; if  $t_{\text{rWD}} \geq t_{\text{rWD}}(\text{min})$ , the  $t_{\text{CWD}} \geq t_{\text{CWD}}(\text{min})$ , and  $t_{\text{AWD}} \geq t_{\text{AWD}}(\text{min})$ , or  $t_{\text{CWD}} \geq t_{\text{CWD}}(\text{min})$ ,  $t_{\text{AWD}} \geq t_{\text{AWD}}(\text{min})$  and  $t_{\text{CPW}} \geq t_{\text{CPW}}(\text{min})$ , the cycle is a read-modify-write and the data output will contain data read from the selected cell; if neither of the above sets of conditions is satisfied, the condition of the data out (at access time) is indeterminate.
15. These parameters are referenced to CAS leading edge in early write cycles and to WE leading edge in delayed write or read-modify-write cycles.
16.  $t_{\text{RASC}}$  defines RAS pulse width in fast page mode cycles.
17. Access time is determined by the longer of  $t_{\text{AA}}$  or  $t_{\text{CAC}}$  or  $t_{\text{ACP}}$



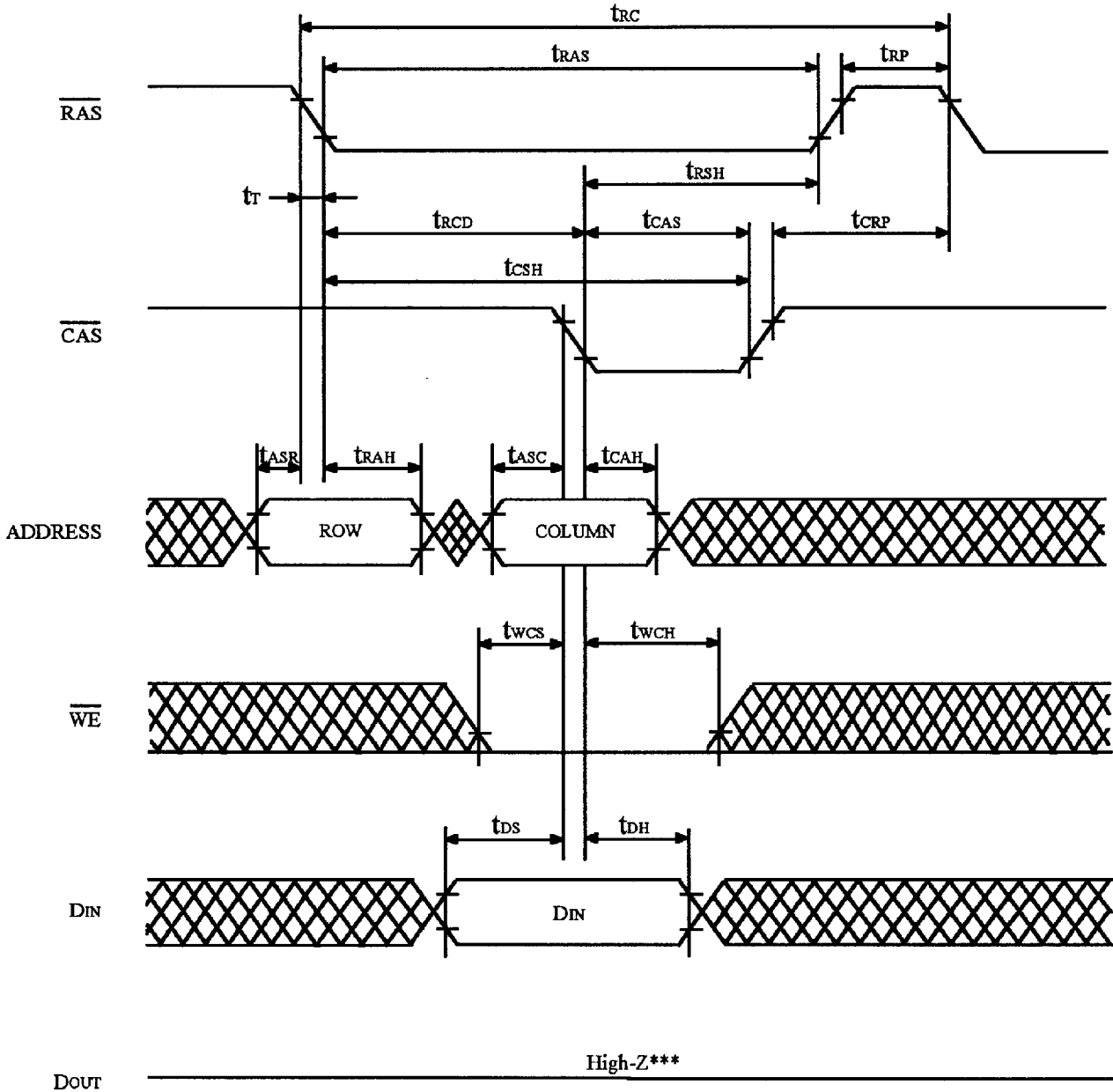



18. In delayed write or read-modify-write cycles,  $\overline{OE}$  must disable output buffer prior to applying data to the device. After  $\overline{RAS}$  is reset, if  $t_{OE} \geq t_{CWL}$ , the I/O pin will remain open circuit (high impedance); if  $t_{OE} \leq t_{CWL}$ , invalid data will be out at each I/O.
19. The 16M DRAM offers a 16-bit time saving parallel test mode. Address CA0 and CA1 for the 4M x 4 are don't care during test mode. Test mode is set by performing a  $\overline{WE}$ -and- $\overline{CAS}$ -before- $\overline{RAS}$  (WCBR) cycle. In 16-bit parallel test mode, data is written into 4 bits in parallel at each I/O (I/O1 to I/O4) and read out from each I/O. If 4 bits of each I/O are equal (all 1s or 0s), data output pin is high state during test mode read cycle, then the device has passed. If they are not equal, data output pin is a low state, then the device has failed. Refresh during test mode operation can be performed by normal read cycles or by WCBR refresh cycles. To get out of test mode and enter a normal operation mode, perform either a regular  $\overline{CAS}$ -before- $\overline{RAS}$  refresh cycle or  $\overline{RAS}$ -only refresh cycle.
20. In a test mode read cycle, the value of  $t_{RAC}$ ,  $t_{AA}$ ,  $t_{CAC}$  and  $t_{ACP}$  is delayed by 2ns to 5ns for the specified value. These parameters should be specified in test mode cycles by adding the above value to the specified value in this data sheet.

**Timing Waveforms**



**FIGURE 1. READ CYCLE**

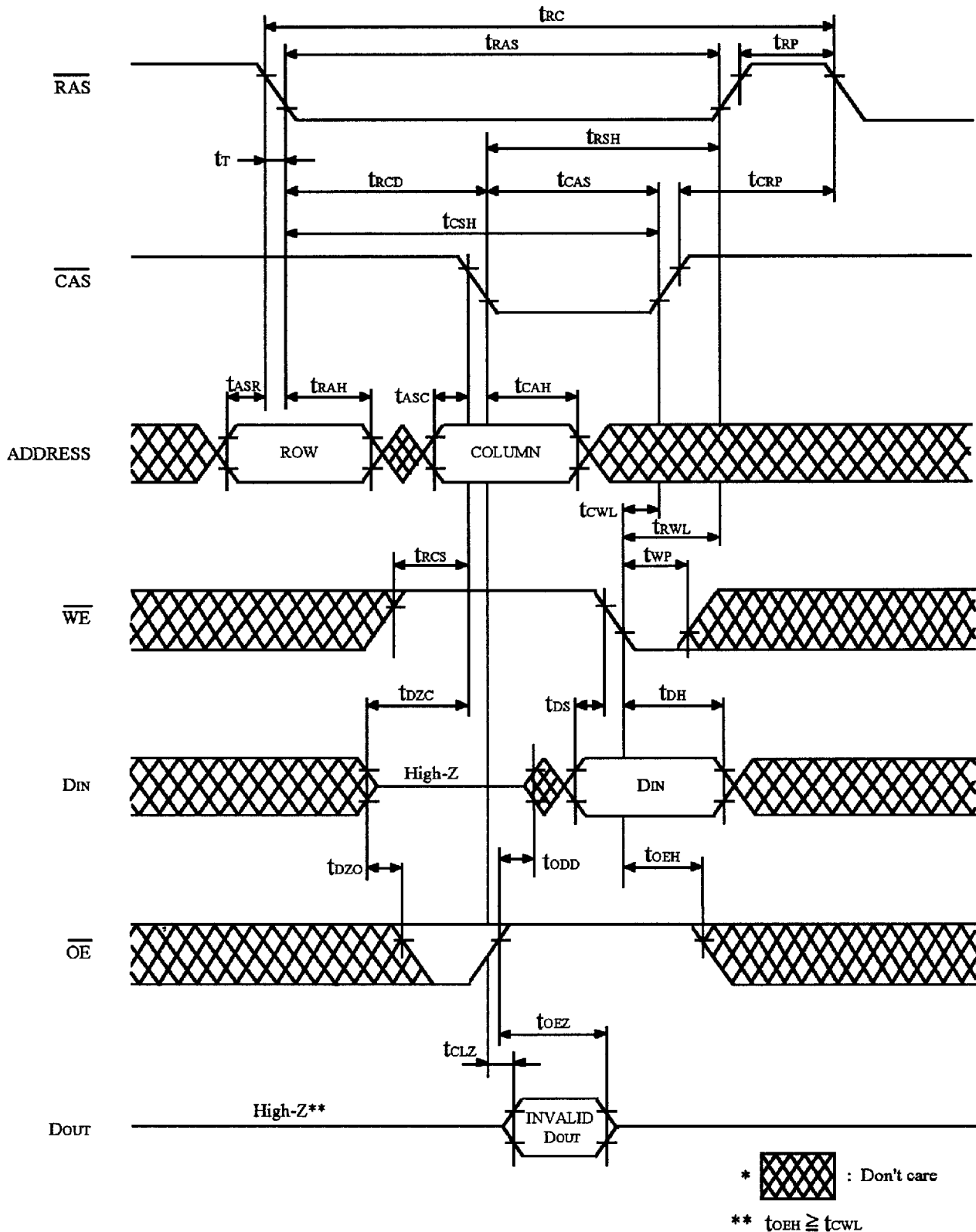


\*  : Don't care

\*\*  $\overline{OE}$  : Don't care

\*\*\*  $t_{wcs} \geq t_{wcs}(\text{min})$

FIGURE 2. EARLY WRITE CYCLE



**FIGURE 3. DELAYED WRITE CYCLE** <sup>\*18</sup>

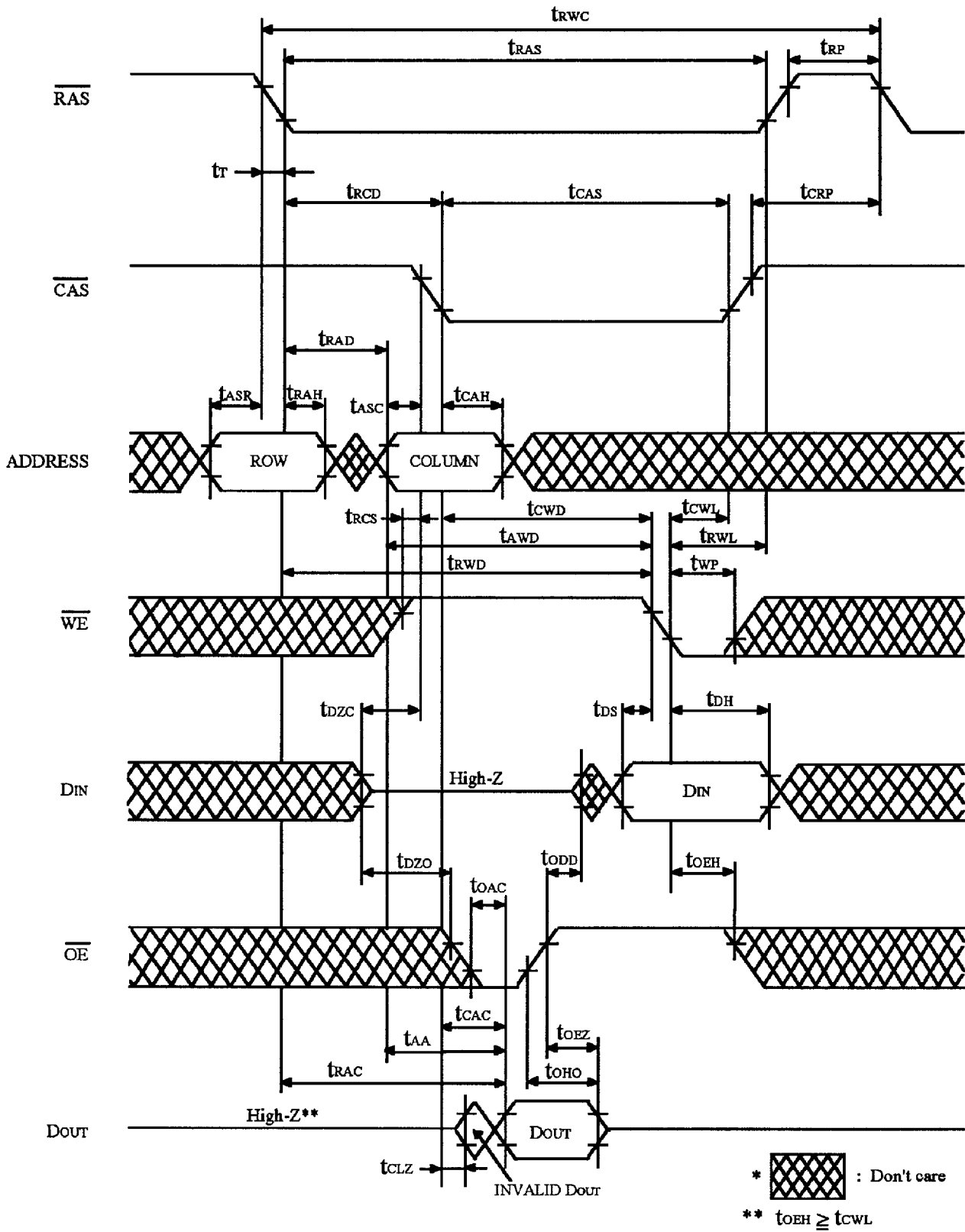
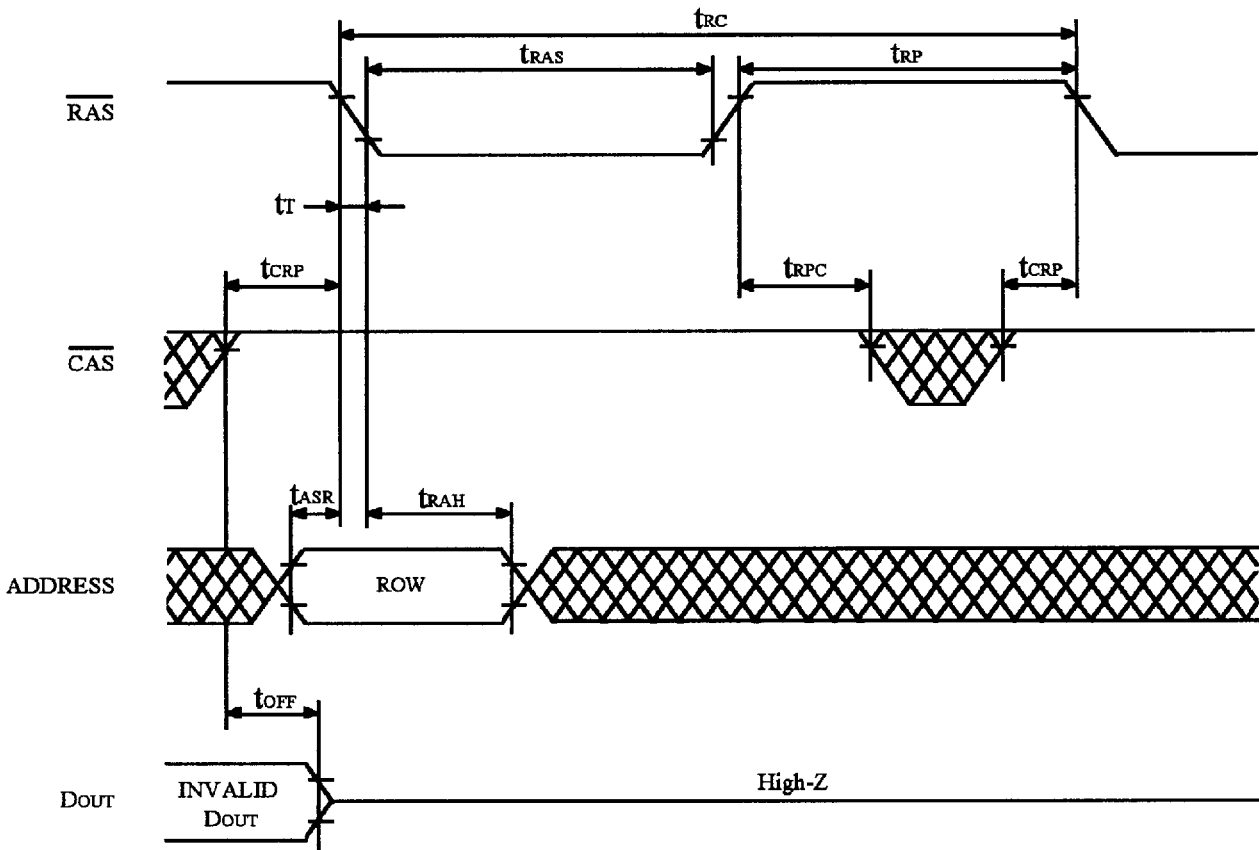


FIGURE 4. READ MODIFY WRITE CYCLE<sup>\*18</sup>



\*  : Don't care

\*\*  $\overline{\text{OE}}, \overline{\text{WE}}$  : Don't care

\*\*\* Refresh Address :  
A0 - A10 (RA0 - RA10)

FIGURE 5.  $\overline{\text{RAS}}$  ONLY REFRESH CYCLE

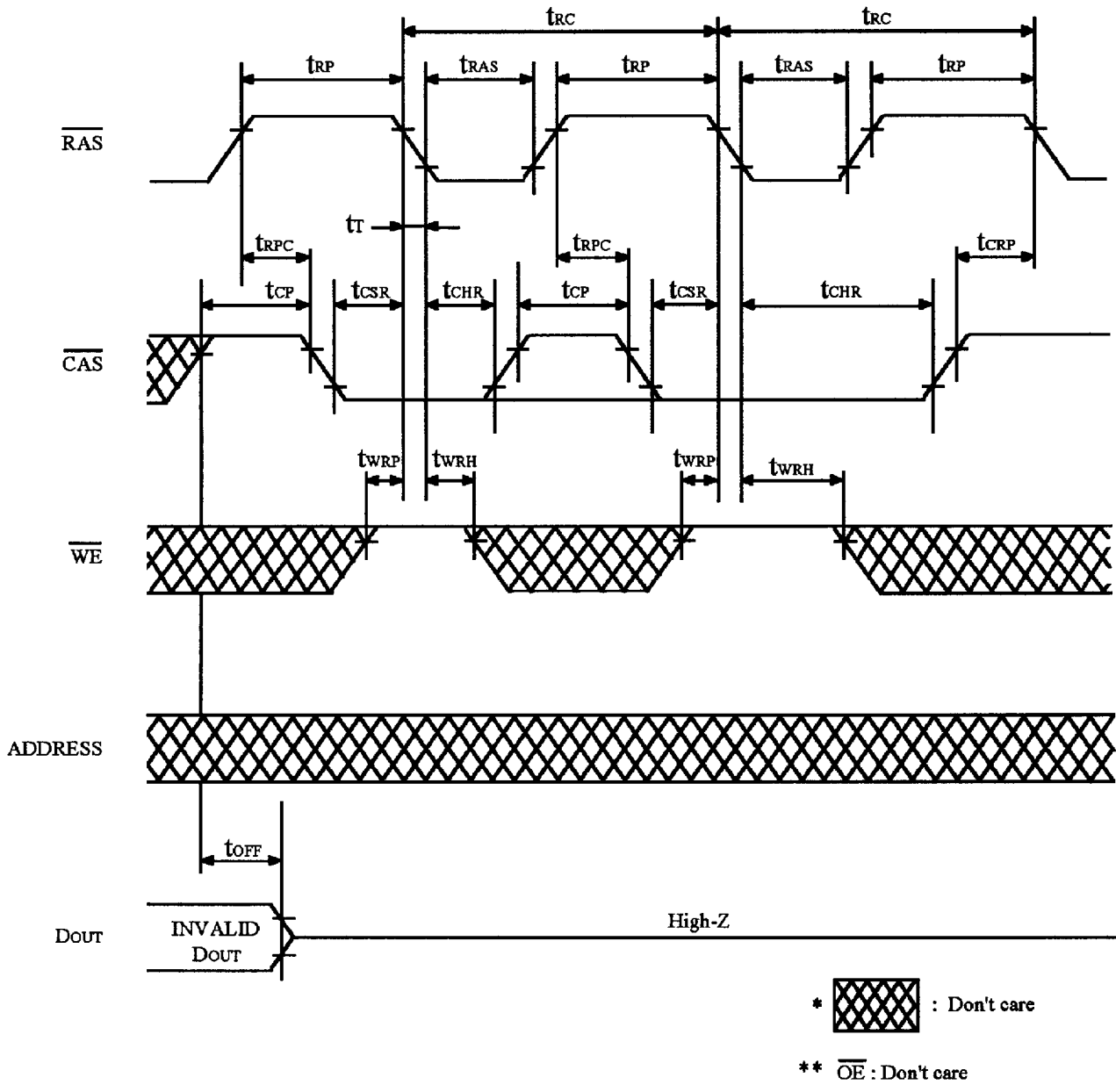


FIGURE 6.  $\overline{CAS}$  BEFORE  $\overline{RAS}$  REFRESH CYCLE

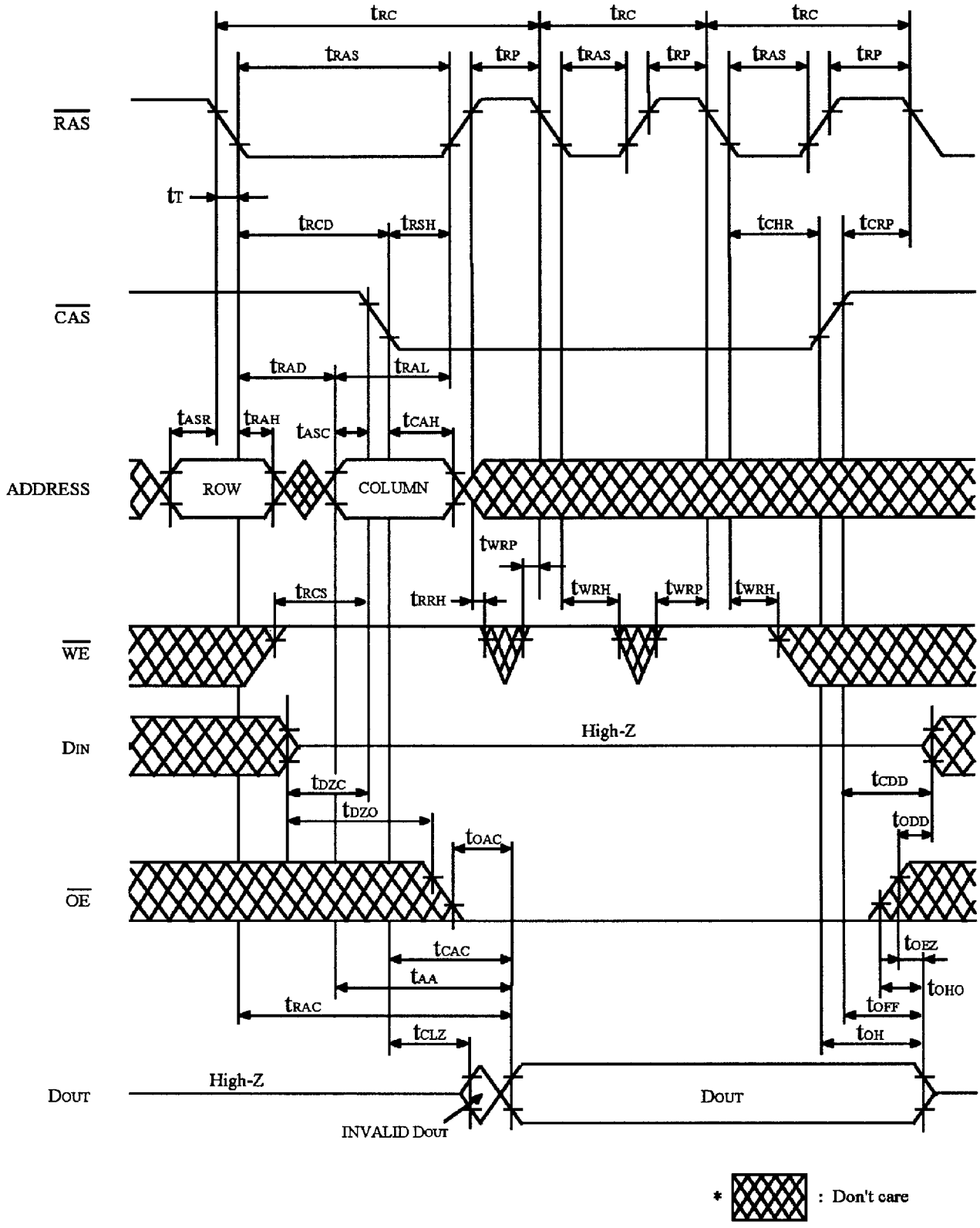
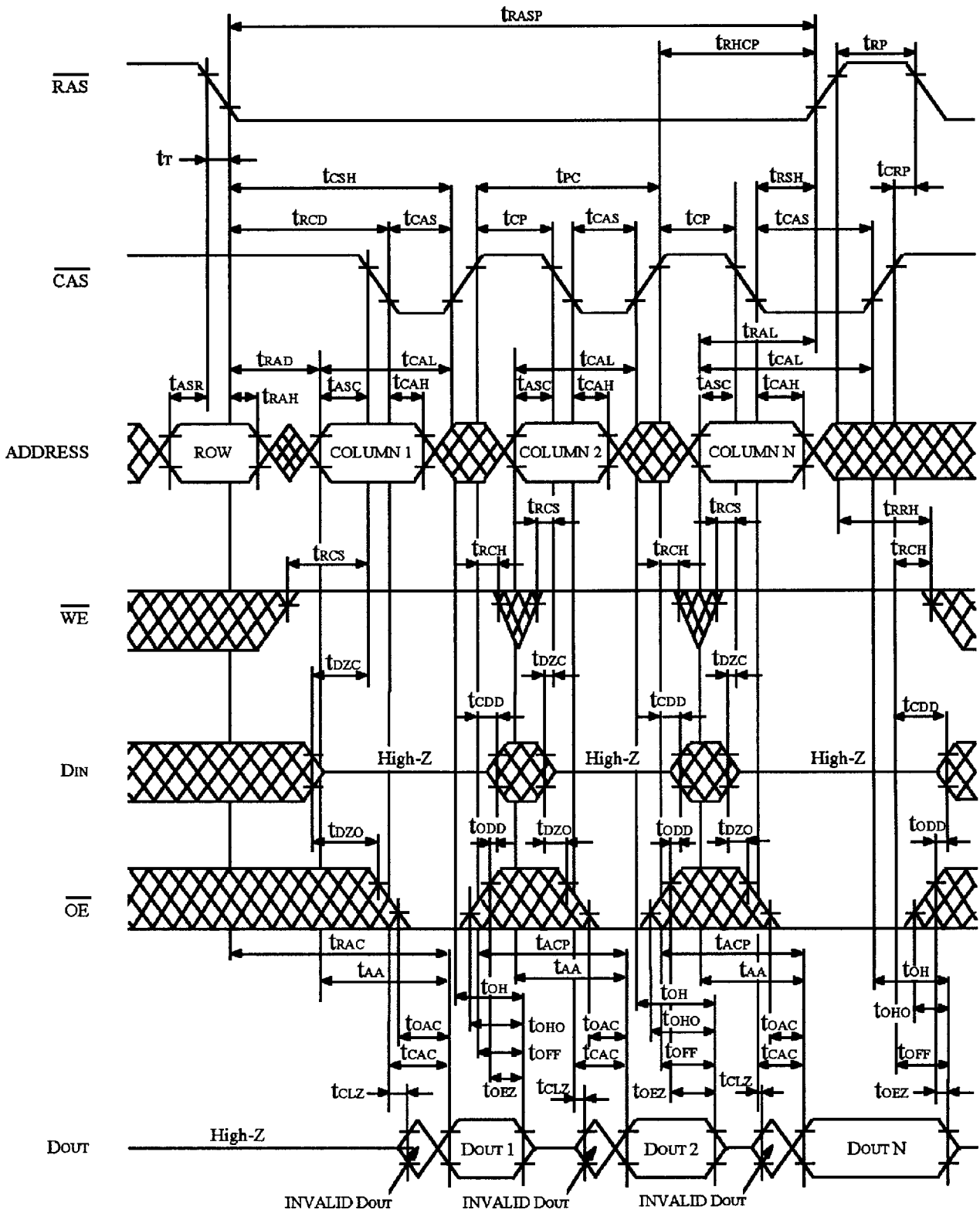
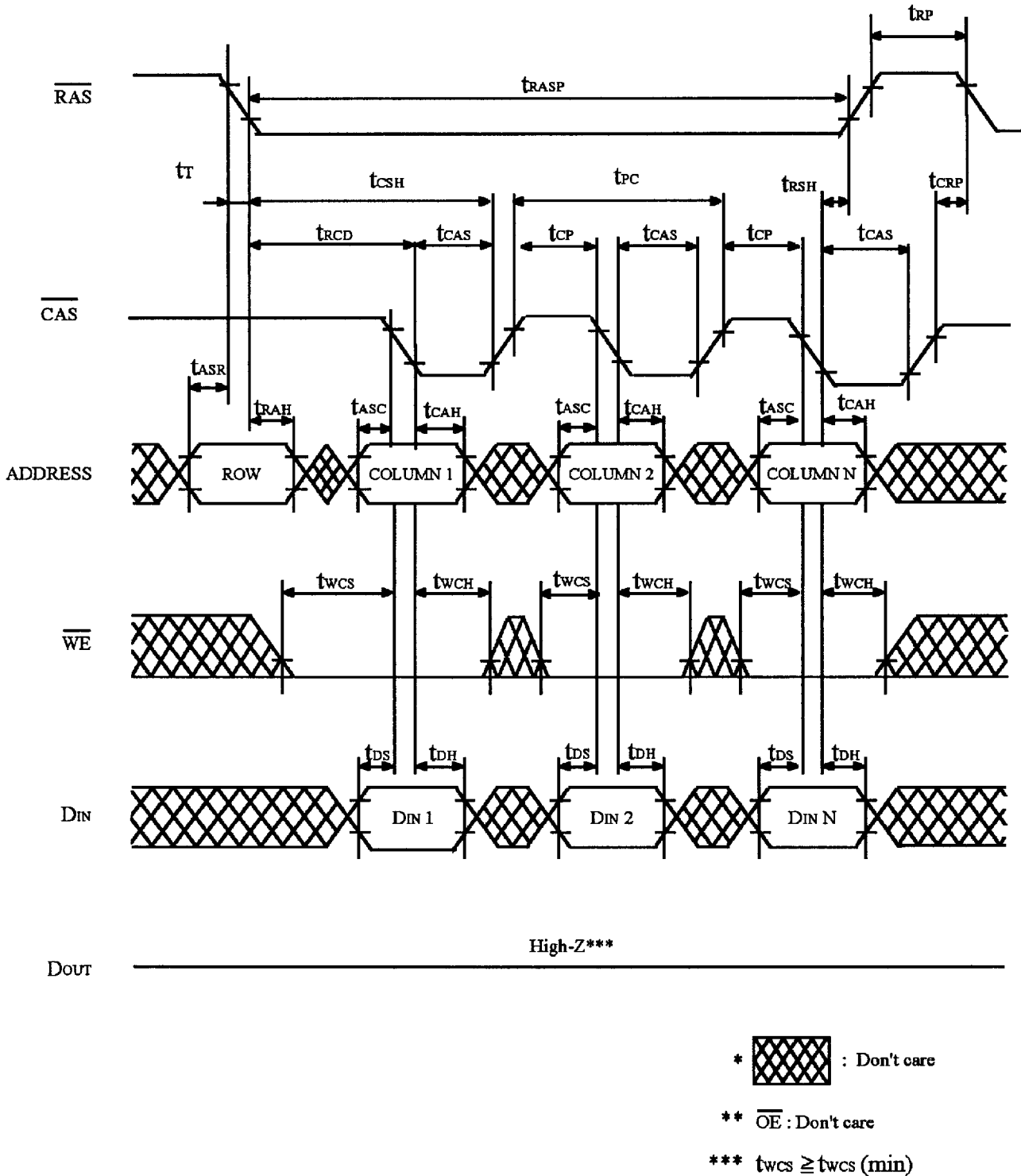


FIGURE 7. HIDDEN REFRESH CYCLE





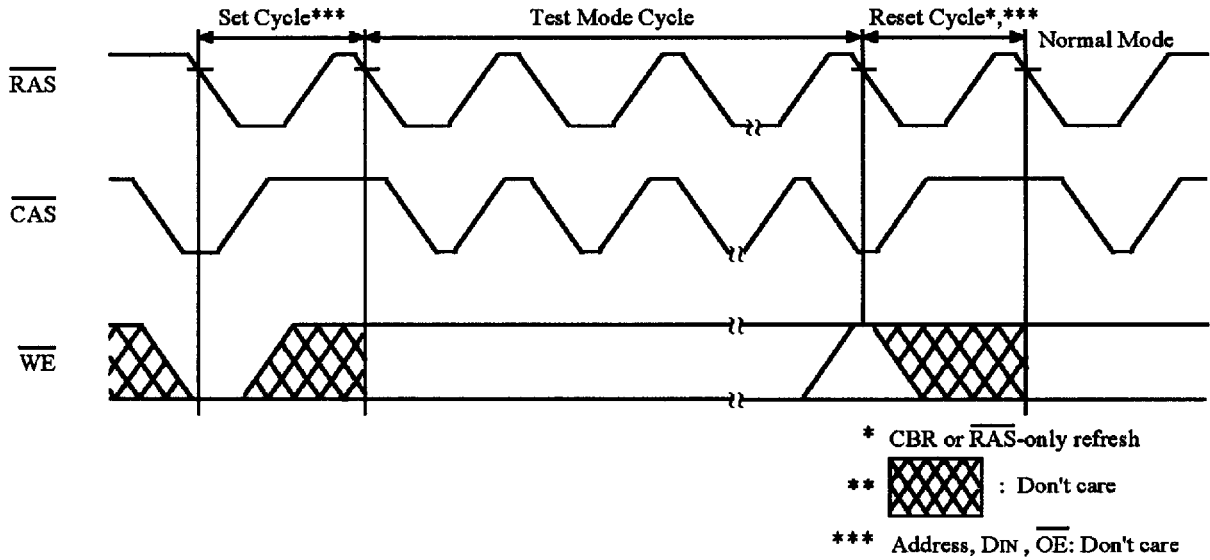
**FIGURE 8. FAST PAGE MODE READ CYCLE**



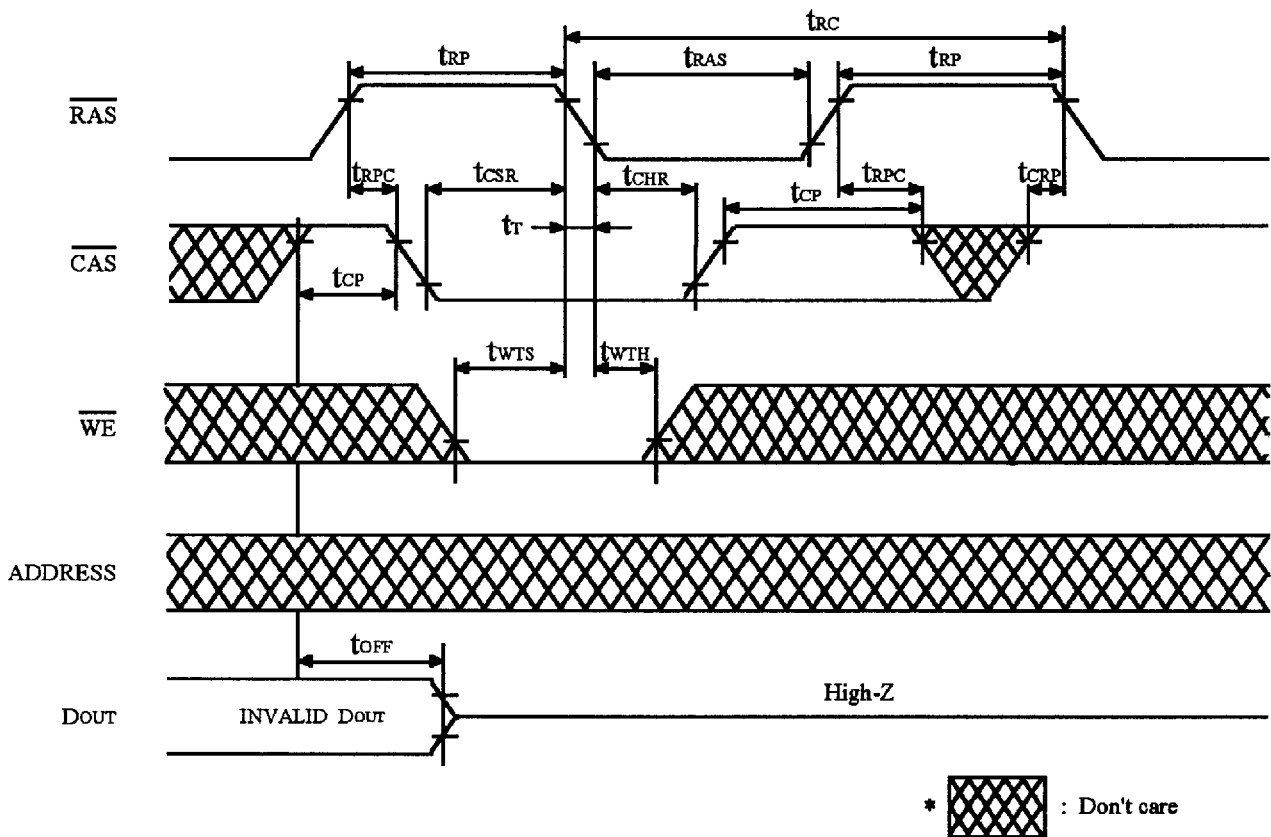
**FIGURE 9. FAST PAGE MODE EARLY WRITE CYCLE**





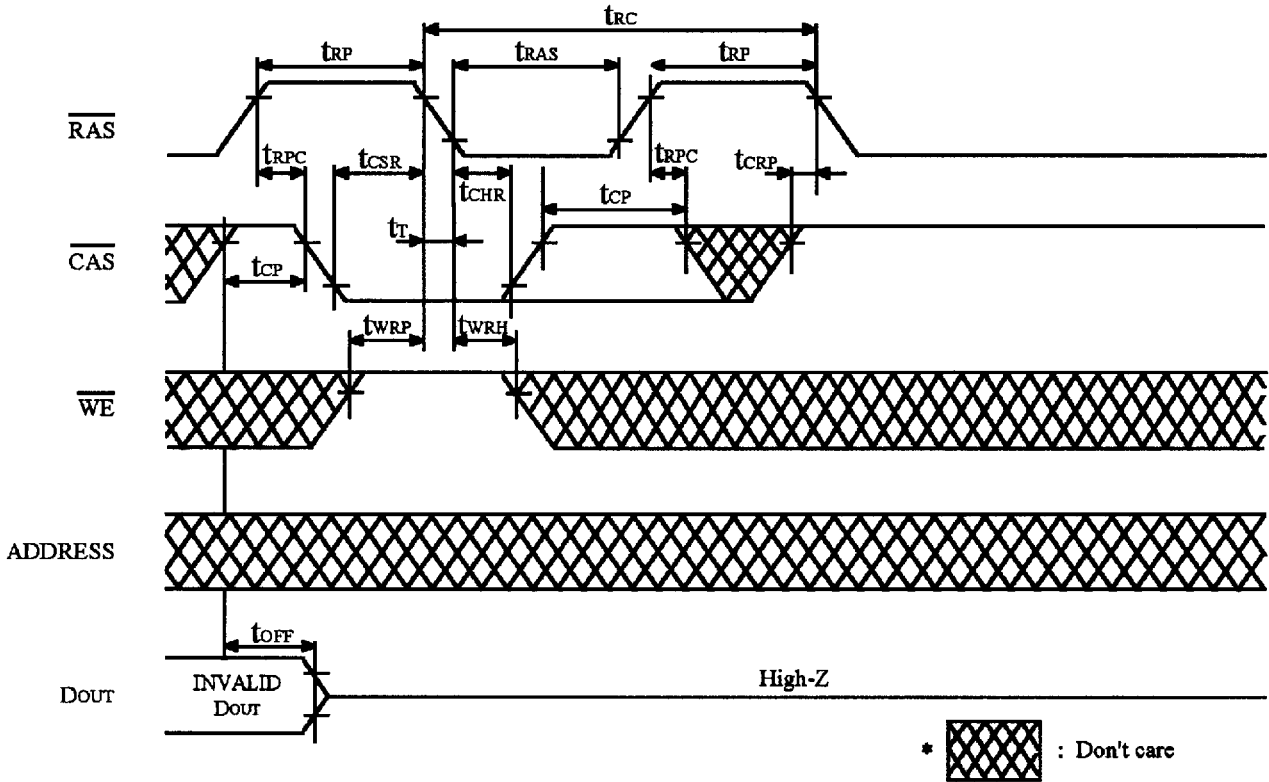


**FIGURE 12. TEST MODE CYCLE \*19**

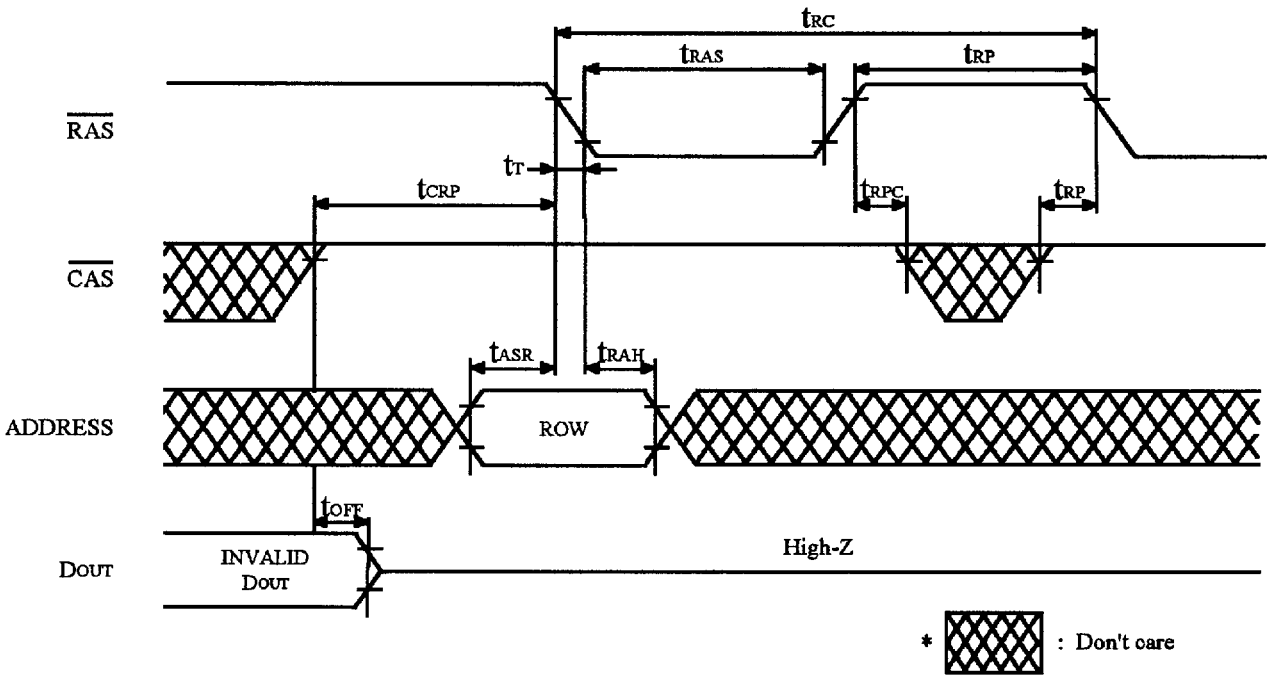


**FIGURE 13. TEST MODE SET CYCLE**

**Test Mode Reset Cycle**



**FIGURE 14.  $\overline{\text{CAS}}$  BEFORE  $\overline{\text{RAS}}$  REFRESH CYCLE**



\*\* Refresh Address :  
A0-A10 (RA0-RA10)

**FIGURE 15.  $\overline{\text{RAS}}$  ONLY REFRESH CYCLE**

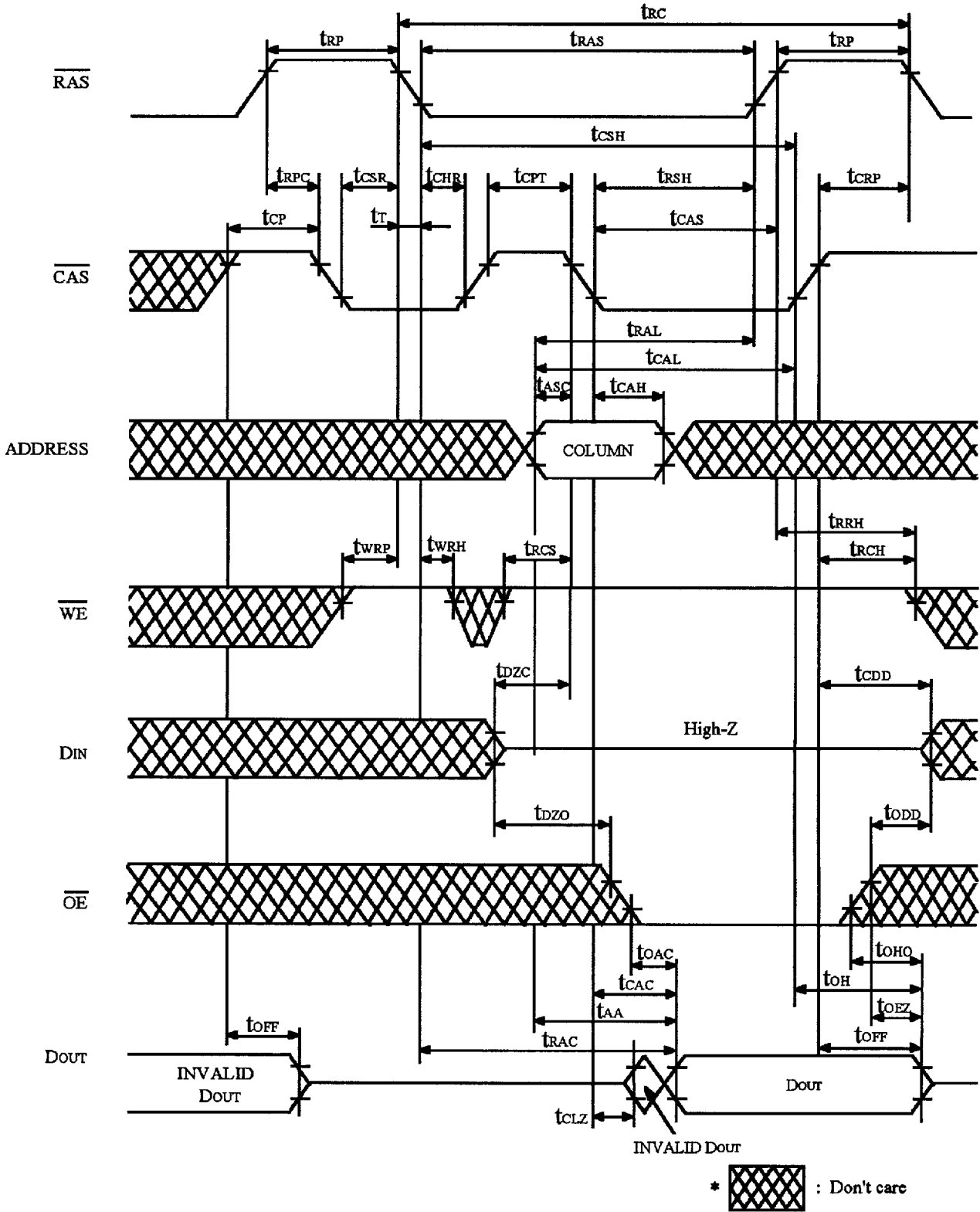


FIGURE 16.  $\overline{\text{CAS}}$  BEFORE  $\overline{\text{RAS}}$  REFRESH COUNTER CHECK CYCLE (READ)

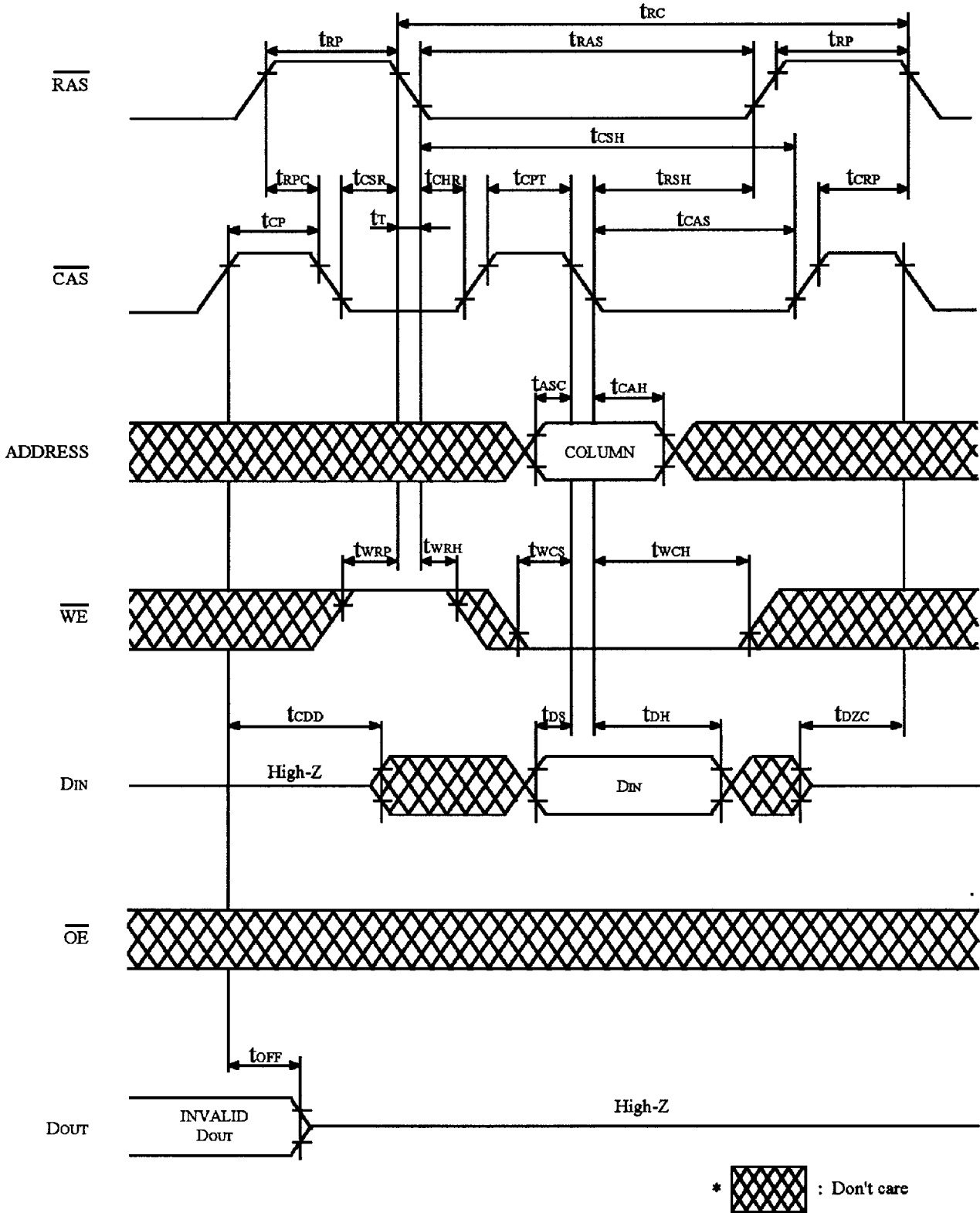
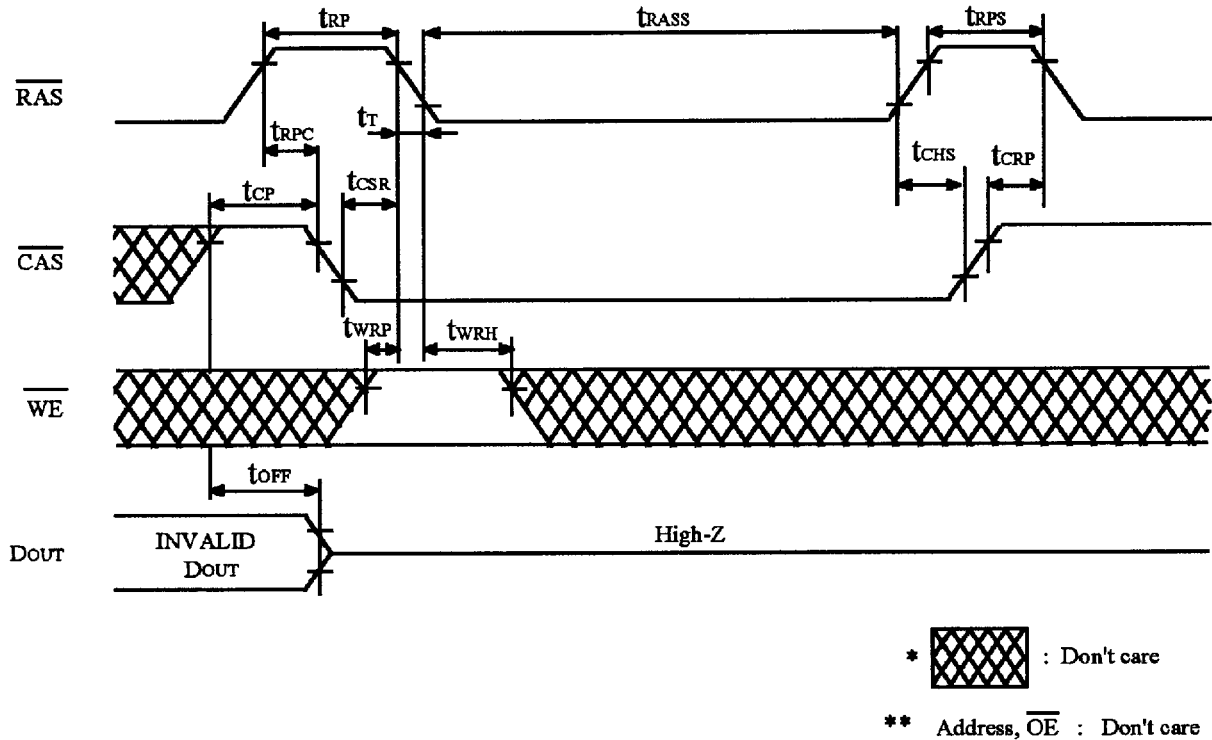


FIGURE 17.  $\overline{\text{CAS}}$  BEFORE  $\overline{\text{RAS}}$  REFRESH COUNTER CHECK CYCLE (WRITE)





The low self refresh current is achieved by introducing extremely long internal refresh cycle. Therefore some care needs to be taken on the refresh.

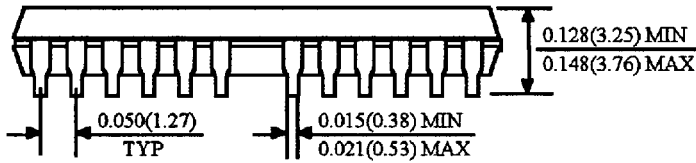
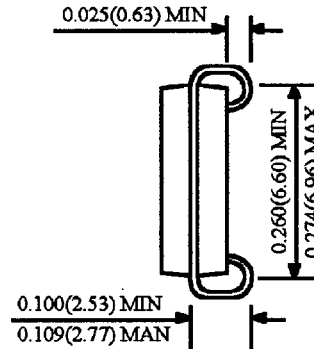
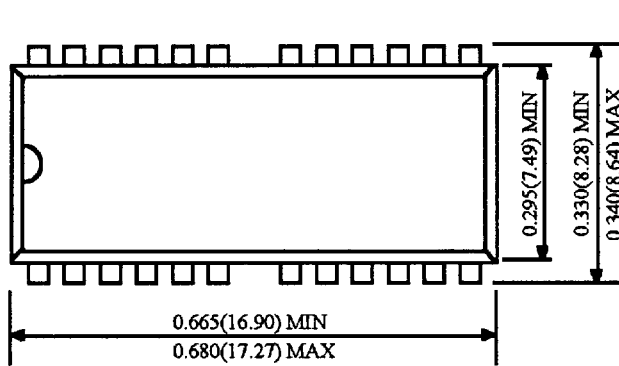
1. Please do not use  $t_{RASS}$  timing,  $10\mu\text{s} \leq t_{RASS} \leq 100\mu\text{s}$ . During this period, the device is in transition state from normal operation mode to self refresh mode. If  $t_{RASS} \geq 100\mu\text{s}$ , then  $\overline{\text{RAS}}$  precharge time should use  $t_{RPS}$  instead of  $t_{RP}$ .
2. If you use  $\overline{\text{RAS}}$  only refresh or CBR burst refresh mode in normal read/write cycle, 2048 cycles of distributed CBR refresh with  $15.6\mu\text{s}$  interval should be executed within 32ms immediately after exiting from and before entering into the self refresh mode.
3. If you use distributed CBR refresh mode with  $15.6\mu\text{s}$  interval in normal read/write cycle, CBR refresh should be executed within  $15.6\mu\text{s}$  immediately after exiting from and before entering into the self refresh mode.
4. Repetitive self refresh mode without refreshing all memory is not allowed. Once you exit from self refresh mode, all memory cells need to be refreshed before re-entering the self refresh mode again.

FIGURE 18. SELF REFRESH CYCLE

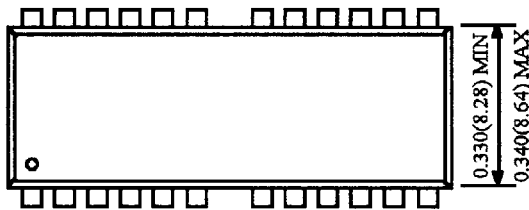
**Package Dimension**

Unit: Inches (mm)

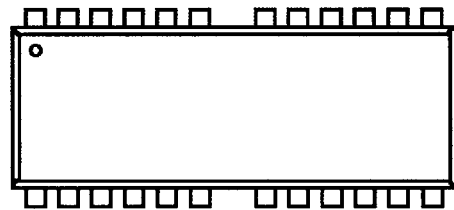
**24 (26) SOJ**



**24 (26) TSOP(TYPE II)**



**NORMAL TYPE**



**REVERSE TYPE**

