

Long-life grade capacitors

Applications

- Frequency converters
- Switch-mode power supplies in industrial and consumer electronics
- Uninterruptible power supplies

Features

- Extremely small dimensions
- High ripple current capability
- Many different case sizes
- Pinning ensures correct insertion

Construction

- Charge-discharge proof, polar
- Aluminum case, fully insulated
- Overload protection by preset break point in case

Terminals

- 4 snap-in terminals (6,3 mm and 4,5 mm length)
- Solder pin mounting on printed circuit boards, pins fit standardized spacings on PCB



KAL0409-D

B43510

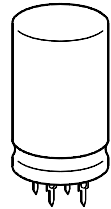

KAL0273-2

B43520

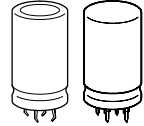
Specifications and characteristics in brief

Rated voltage U_R	385 ... 500 VDC	
Surge voltage U_S	$1,1 \cdot U_R$	
Rated capacitance C_R	390 ... 2 700 μF	
Capacitance tolerance	$\pm 20 \% \triangleq \text{M}$	
Leakage current I_L (5 min, 20 °C)	$I_L \leq 0,3 \mu\text{A} \cdot \left(\frac{C_R}{\mu\text{F}} \cdot \frac{U_R}{\text{V}} \right)^{0,7} + 4 \mu\text{A}$	
Self-inductance ESL	Approx. 20 nH	
Useful life 85 °C; U_R ; $I_{\sim R}$ 40 °C; U_R ; $1,1 \cdot I_{\sim R}$	$> 5\ 000\ \text{h}$ $> 250\ 000\ \text{h}$	Requirements: $\Delta C/C \leq \pm 30\ \%$ of initial value $ESR \leq 3$ times initial specified limit $I_L \leq$ initial specified limit Failure percentage: $\leq 1\ \%$ Failure rate: $\leq 40\ \text{fit}$ ($\leq 40 \cdot 10^{-9}/\text{h}$) (for definition "fit", refer to chapter "Quality", page 62)
Voltage endurance test 85 °C; U_R	2 000 h	Post test requirements: $\Delta C/C \leq \pm 10\ \%$ of initial value $ESR \leq 1,3$ times initial specified limit $I_L \leq$ initial specified limit
Vibration resistance	To IEC 60068-2-6, test Fc: displacement amplitude 0,35 mm, frequency range 10 ... 55 Hz, acceleration max. 5 g, duration $3 \times 2\ \text{h}$	
IEC climatic category	To IEC 60068-1: $U_R \leq 400\ \text{VDC}$: 40/085/56 (– 40 °C/+ 85 °C/56 days damp heat test) $U_R > 400\ \text{VDC}$: 25/085/56 (– 25 °C/+ 85 °C/56 days damp heat test)	
Detail specification	Similar to CECC 30301-805	
Sectional specification	IEC 60384-4	

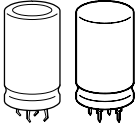

B43510 / B43520

Miniaturized – 85 °C

Dimensional drawings

B43510, 4 snap-in terminals

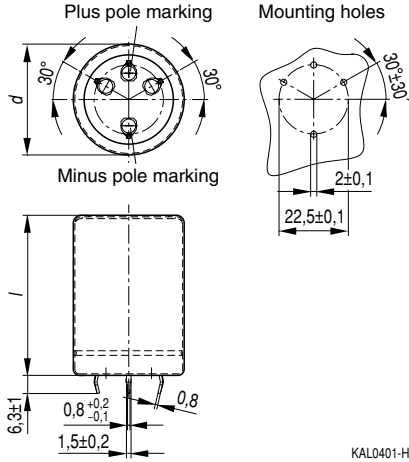

KAL0401-H

Standard snap-in terminals: length $(6,3 \pm 1)$ mm.
 Also available with a length of $(4,5 - 1)$ mm.
 For ordering example cf. page 181

Dimensions (mm)			Approx. weight (g)	Packing units (pieces)
$d+1$	$l \pm 2$	l_{max}		
35	50	54	63	60
35	60	64	76	36
35	70	74	88	36
35	80	84	101	36
35	100	104	126	36
40	40	44	71	33
40	50	54	89	33
40	60	64	107	33
40	70	74	125	33
40	80	84	143	33
40	100	104	178	33
45	40	—	90	28
45	50	—	113	28
45	60	—	136	28
45	70	—	158	28
45	80	—	181	28
45	100	—	226	28

B43520, solder pins

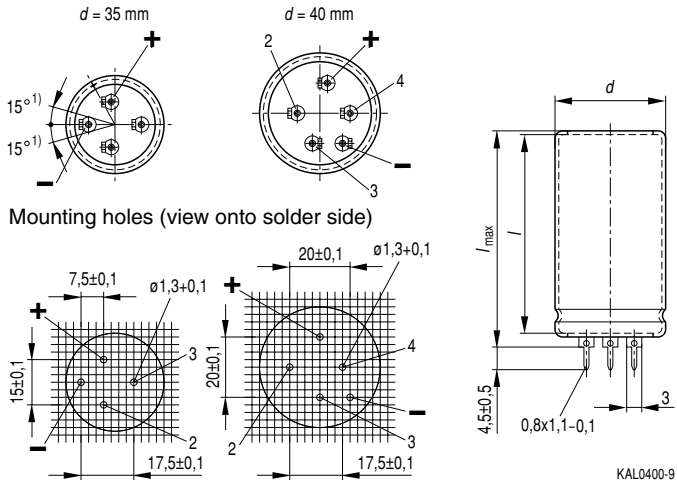

1) Permissible range of positions for pole identification marks

Pole markings: Plus: **+**; Minus: **-**

All pin holes must be drilled into the PC-board, since the unconnected pins serve as mountings. These pins must be soldered to isolated pads or pads with the same potential as the negative pole (solder pin and 4 snap-in terminals).

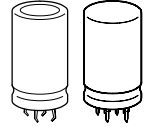

Packing

B43510 / B43520

Miniaturized – 85 °C

Packing of 4 snap-in terminals and solder pins



For ecological reasons the packing is pure cardboard.

Ordering codes

4 snap-in terminals Version	Identification in 3rd block of ordering code
Standard terminals (6,3 ± 1) mm	M000
Short terminals (4,5 – 1) mm	M007

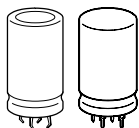

Overview of available types

U_R (VDC)	385	400	420	450	500
C_R (μ F)	Case dimensions $d \times l$ (mm)				
390					35 × 60
470					35 × 70
560				35 × 60	35 × 70 40 × 60
680	35 × 50 40 × 50	35 × 60 40 × 50	35 × 60 40 × 50	35 × 70 40 × 50	35 × 100 40 × 70
820	35 × 60 40 × 50	35 × 60 40 × 50	35 × 70 40 × 60	35 × 80 40 × 60	35 × 100 40 × 80
1 000	35 × 70 40 × 60	35 × 70 40 × 60 45 × 50	35 × 80 40 × 60	35 × 100 40 × 70 45 × 60	40 × 100 45 × 70
1 200	35 × 80 40 × 70	35 × 100 40 × 70	40 × 70	40 × 80 45 × 70	45 × 100
1 500	40 × 80 45 × 60	35 × 100 40 × 80 45 × 70	40 × 100 45 × 70	40 × 100 45 × 80	45 × 100
1 800	40 × 100 45 × 70	40 × 100 45 × 80	40 × 100 45 × 80	45 × 100	
2 200	40 × 100	45 × 100		45 × 100	
2 700	45 × 100	45 × 100			

The capacitance and voltage ratings listed above are available in different cases upon request.

Other voltage and capacitance ratings are also available upon request.

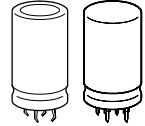
Capacitors with solder pins are only available in 35 and 40 mm case diameters.

Technical data and ordering codes

U_R	C_R 100 Hz 20 °C μF	Case dimensions $d \times l$ mm	ESR_{max} 100 Hz 20 °C mΩ	Z_{max} 10 kHz 20 °C mΩ	I_{-max} 100 Hz 40 °C A	I_{-R} 100 Hz 85 °C A	Ordering code ¹⁾ * 1 = 4 snap-in 2 = solder pin
385	680	35 × 50	190	150	7,7	3,5	B435*0A3687M000
	680	40 × 50	190	150	8,1	3,7	B435*0B3687M000
	820	35 × 60	160	130	9,0	4,1	B435*0A3827M000
	820	40 × 50	160	130	8,9	4,0	B435*0B3827M000
	1000	35 × 70	130	110	10,6	4,8	B435*0A3108M000
	1000	40 × 60	130	110	10,5	4,8	B435*0B3108M000
	1200	35 × 80	110	90	12,3	5,6	B435*0A3128M000
	1200	40 × 70	110	90	12,2	5,5	B435*0B3128M000
	1500	40 × 80	90	70	14,4	6,5	B435*0A3158M000
	1500	45 × 60	90	70	12,9	5,9	B43510B3158M000
	1800	40 × 100	80	60	17,2	7,8	B435*0A3188M000
	1800	45 × 70	80	60	14,9	6,8	B43510B3188M000
	2200	40 × 100	60	50	19,1	8,7	B435*0A3228M000
	2700	45 × 100	50	40	21,1	9,6	B43510A3278M000
400	680	35 × 60	190	150	8,2	3,7	B435*0A9687M000
	680	40 × 50	190	150	8,1	3,7	B435*0B9687M000
	820	35 × 60	160	130	9,0	4,1	B435*0A9827M000
	820	40 × 50	160	130	8,9	4,0	B435*0B9827M000
	1000	35 × 70	130	110	10,6	4,8	B435*0A9108M000
	1000	40 × 60	130	110	10,5	4,8	B435*0B9108M000
	1000	45 × 50	130	110	9,9	4,5	B43510C9108M000
	1200	35 × 100	110	90	13,5	6,1	B435*0A9128M000
	1200	40 × 70	110	90	12,2	5,5	B435*0B9128M000
	1500	35 × 100	90	70	15,0	6,8	B435*0A9158M000
	1500	40 × 80	90	70	14,4	6,5	B435*0B9158M000
	1500	45 × 70	90	70	13,6	6,2	B43510C9158M000
	1800	40 × 100	80	60	17,2	7,8	B435*0A9188M000
	1800	45 × 80	80	60	15,7	7,2	B43510B9188M000
	2200	45 × 100	60	50	19,0	8,6	B43510A9228M000
	2700	45 × 100	50	40	21,1	9,6	B43510A9278M000

Capacitors with solder pins are only available in 35 and 40 mm case diameters.

1) For capacitors with short 4 snap-in terminals, see page 181.

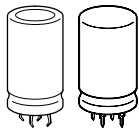
Technical data and ordering codes

U_R VDC	C_R 100 Hz 20 °C μF	Case dimensions $d \times l$ mm	ESR_{max} 100 Hz 20 °C m Ω	Z_{max} 10 kHz 20 °C m Ω	I_{max} 100 Hz 40 °C A	I_{R} 100 Hz 85 °C A	Ordering code ¹⁾ * 1 = 4 snap-in 2 = solder pin
420	680	35 × 60	300	240	8,2	3,7	B435*0A0687M000
	680	40 × 50	300	240	8,1	3,7	B435*0B0687M000
	820	35 × 70	250	200	9,6	4,4	B435*0A0827M000
	820	40 × 60	250	200	9,5	4,3	B435*0B0827M000
	1000	35 × 80	200	160	11,2	5,1	B435*0A0108M000
	1000	40 × 60	200	160	10,5	4,8	B435*0B0108M000
	1200	40 × 70	170	140	12,2	5,5	B435*0A0128M000
	1500	40 × 100	140	110	15,7	7,2	B435*0A0158M000
	1500	45 × 70	140	110	13,6	6,2	B43510B0158M000
	1800	40 × 100	120	90	17,2	7,8	B435*0A0188M000
1800	45 × 80	120	90	15,7	7,2	B43510B0188M000	
450	560	35 × 60	360	290	7,5	3,4	B435*0A5567M000
	680	35 × 70	300	240	8,7	4,0	B435*0A5687M000
	680	40 × 50	300	240	8,1	3,7	B435*0B5687M000
	820	35 × 80	250	200	10,1	4,6	B435*0A5827M000
	820	40 × 60	250	200	9,5	4,3	B435*0B5827M000
	1000	35 × 100	200	160	12,3	5,6	B435*0A5108M000
	1000	40 × 70	200	160	11,1	5,1	B435*0B5108M000
	1000	45 × 60	200	160	10,5	4,8	B43510C5108M000
	1200	40 × 80	170	140	12,8	5,8	B435*0A5128M000
	1200	45 × 70	170	140	12,2	5,5	B43510B5128M000
	1500	40 × 100	140	110	15,7	7,2	B435*0A5158M000
	1500	45 × 80	140	110	14,4	6,5	B43510B5158M000
	1800	45 × 100	120	90	17,2	7,8	B43510A5188M000
	2200	45 × 100	100	80	19,0	8,6	B43510A5228M000

Capacitors with solder pins are only available in 35 and 40 mm case diameters.

1) For capacitors with short 4 snap-in terminals, see page 181.

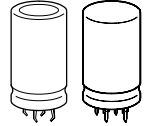
Technical data and ordering codes

U_R	C_R 100 Hz 20 °C VDC μF	Case dimensions $d \times l$ mm	ESR_{max} 100 Hz 20 °C m Ω	Z_{max} 10 kHz 20 °C m Ω	$I_{\text{~max}}$ 100 Hz 40 °C A	$I_{\text{~R}}$ 100 Hz 85 °C A	Ordering code ¹⁾ * 1 = 4 snap-in 2 = solder pin
500	390	35 × 60	520	410	4,1	1,9	B435*0A6397M000
	470	35 × 70	430	340	4,8	2,2	B435*0A6477M000
	560	35 × 70	360	290	5,2	2,4	B435*0A6567M000
	560	40 × 60	360	290	5,1	2,3	B435*0B6567M000
	680	35 × 100	300	240	6,6	3,0	B435*0A6687M000
	680	40 × 70	300	240	6,0	2,7	B435*0B6687M000
	820	35 × 100	250	200	7,3	3,3	B435*0A6827M000
	820	40 × 80	250	200	7,0	3,2	B435*0B6827M000
	1000	40 × 100	200	160	8,4	3,8	B435*0A6108M000
	1000	45 × 70	200	160	7,3	3,3	B43510B6108M000
	1200	45 × 100	170	140	9,2	4,2	B43510A6128M000
	1500	45 × 100	140	110	10,3	4,7	B43510A6158M000

Capacitors with solder pins are only available in 35 and 40 mm case diameters.

1) For capacitors with short 4 snap-in terminals, see page 181.

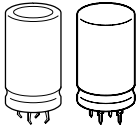

B43510 / B43520

Miniaturized – 85 °C

Useful life

depending on ambient temperature T_A under ripple current operating conditions¹⁾

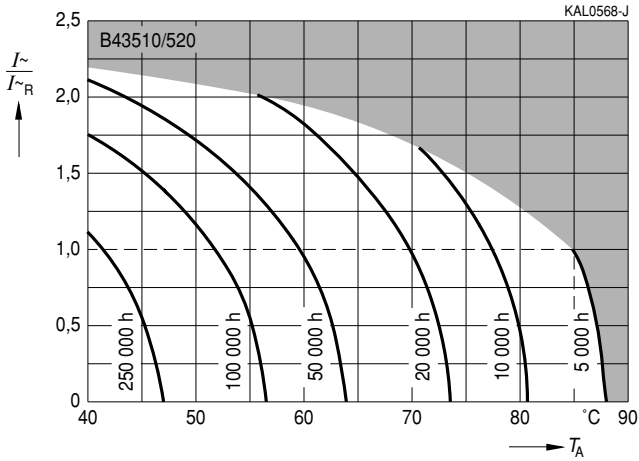

Frequency factor of permissible ripple current I_{\sim} versus frequency f

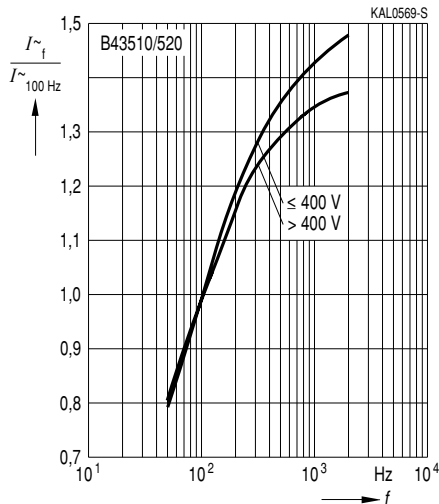

Frequency characteristics of ESR
 Typical behavior

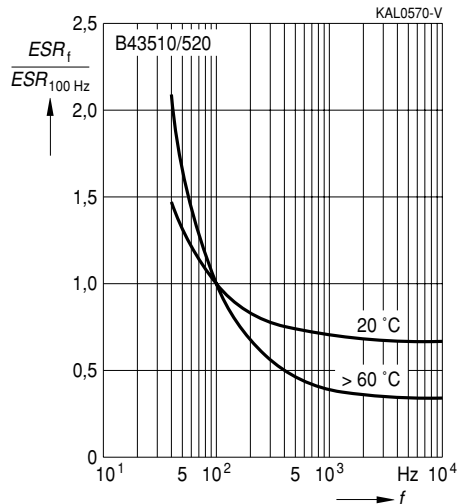

1) Refer to page 40 for an explanation on how to interpret the useful life graphs.

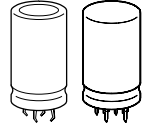

Impedance Z at $f = 10$ kHz
 versus frequency f
 Typical behavior at 20 °C

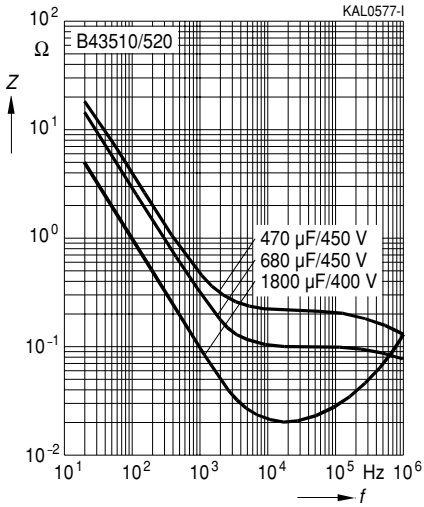

Herausgegeben von EPCOS AG

Unternehmenskommunikation, Postfach 80 17 09, 81617 München, DEUTSCHLAND

☎ ++49 89 636 09, FAX (0 89) 636-2 26 89

© EPCOS AG 2002. Vervielfältigung, Veröffentlichung, Verbreitung und Verwertung dieser Broschüre und ihres Inhalts ohne ausdrückliche Genehmigung der EPCOS AG nicht gestattet.

Bestellungen unterliegen den vom ZVEI empfohlenen Allgemeinen Lieferbedingungen für Erzeugnisse und Leistungen der Elektroindustrie, soweit nichts anderes vereinbart wird.

Diese Broschüre ersetzt die vorige Ausgabe.

Fragen über Technik, Preise und Liefermöglichkeiten richten Sie bitte an den Ihnen nächstgelegenen Vertrieb der EPCOS AG oder an unsere Vertriebsgesellschaften im Ausland. Bauelemente können aufgrund technischer Erfordernisse Gefahrstoffe enthalten. Auskünfte darüber bitten wir unter Angabe des betreffenden Typs ebenfalls über die zuständige Vertriebsgesellschaft einzuholen.

Published by EPCOS AG

Corporate Communications, P.O. Box 80 17 09, 81617 Munich, GERMANY

☎ ++49 89 636 09, FAX (0 89) 636-2 26 89

© EPCOS AG 2002. Reproduction, publication and dissemination of this brochure and the information contained therein without EPCOS' prior express consent is prohibited.

Purchase orders are subject to the General Conditions for the Supply of Products and Services of the Electrical and Electronics Industry recommended by the ZVEI (German Electrical and Electronic Manufacturers' Association), unless otherwise agreed.

This brochure replaces the previous edition.

For questions on technology, prices and delivery please contact the Sales Offices of EPCOS AG or the international Representatives.

Due to technical requirements components may contain dangerous substances. For information on the type in question please also contact one of our Sales Offices.