

APT4016BN 400V 31.0A 0.16Ω

APT4018BN 400V 29.0A 0.18Ω

POWER MOS IV®

N-CHANNEL ENHANCEMENT MODE HIGH VOLTAGE POWER MOSFETS

MAXIMUM RATINGS

All Ratings: $T_C = 25^\circ\text{C}$ unless otherwise specified.

Symbol	Parameter	APT 4016BN	APT 4018BN	UNIT
V_{DSS}	Drain-Source Voltage	400	400	Volts
I_D	Continuous Drain Current @ $T_C = 25^\circ\text{C}$	31	29	Amps
I_{DM}	Pulsed Drain Current ^①	124	116	
V_{GS}	Gate-Source Voltage	± 30		Volts
P_D	Total Power Dissipation @ $T_C = 25^\circ\text{C}$	360		Watts
	Linear Derating Factor	2.9		W/°C
T_J, T_{STG}	Operating and Storage Junction Temperature Range	-55 to 150		°C
T_L	Lead Temperature: 0.063" from Case for 10 Sec.	300		

STATIC ELECTRICAL CHARACTERISTICS

Symbol	Characteristic / Test Conditions / Part Number	MIN	TYP	MAX	UNIT
BV_{DSS}	Drain-Source Breakdown Voltage ($V_{GS} = 0V, I_D = 250 \mu\text{A}$)	APT4016BN	400		Volts
		APT4018BN	400		
$I_{D(ON)}$	On State Drain Current ^② ($V_{DS} > I_{D(ON)} \times R_{DS(ON)}$ Max, $V_{GS} = 10V$)	APT4016BN	31		Amps
		APT4018BN	29		
$R_{DS(ON)}$	Drain-Source On-State Resistance ^② ($V_{GS} = 10V, 0.5 I_D$ [Cont.])	APT4016BN		0.16	Ohms
		APT4018BN		0.18	
I_{DSS}	Zero Gate Voltage Drain Current ($V_{DS} = V_{DSS}, V_{GS} = 0V$)			250	μA
	Zero Gate Voltage Drain Current ($V_{DS} = 0.8 V_{DSS}, V_{GS} = 0V, T_C = 125^\circ\text{C}$)			1000	
I_{GSS}	Gate-Source Leakage Current ($V_{GS} = \pm 30V, V_{DS} = 0V$)			± 100	nA
$V_{GS(TH)}$	Gate Threshold Voltage ($V_{DS} = V_{GS}, I_D = 1.0\text{mA}$)	2		4	Volts

THERMAL CHARACTERISTICS

Symbol	Characteristic	MIN	TYP	MAX	UNIT
$R_{\theta JC}$	Junction to Case			0.34	°C/W
$R_{\theta JA}$	Junction to Ambient			40	



CAUTION: These Devices are Sensitive to Electrostatic Discharge. Proper Handling Procedures Should Be Followed.

USA

405 S.W. Columbia Street
EUROPE

Avenue J.F. Kennedy Bât B4 Parc Cadéra Nord

Bend, Oregon 97702-1035

F-33700 Merignac - France

Phone: (541) 382-8028

Phone: (33) 5 57 92 15 15

FAX: (541) 388-0364

FAX: (33) 5 56 47 97 61

DYNAMIC CHARACTERISTICS

APT4016/4018BN

Symbol	Characteristic	Test Conditions	MIN	TYP	MAX	UNIT
C_{iss}	Input Capacitance	$V_{GS} = 0V$ $V_{DS} = 25V$ $f = 1\text{ MHz}$		2850	3500	pF
C_{oss}	Output Capacitance			690	900	
C_{rss}	Reverse Transfer Capacitance			280	400	
Q_g	Total Gate Charge ^③	$V_{GS} = 10V$ $V_{DD} = 0.5 V_{DSS}$ $I_D = I_D [\text{Cont.}] @ 25^\circ\text{C}$		130	200	nC
Q_{gs}	Gate-Source Charge			20	30	
Q_{gd}	Gate-Drain ("Miller") Charge			60	90	
$t_d(\text{on})$	Turn-on Delay Time	$V_{GS} = 15V$ $V_{DD} = 0.5 V_{DSS}$ $I_D = I_D [\text{Cont.}] @ 25^\circ\text{C}$ $R_G = 1.8\Omega$		15	30	ns
t_r	Rise Time			42	84	
$t_d(\text{off})$	Turn-off Delay Time			90	135	
t_f	Fall Time			65	130	

SOURCE-DRAIN DIODE RATINGS AND CHARACTERISTICS

Symbol	Characteristic / Test Conditions / Part Number	MIN	TYP	MAX	UNIT
I_S	Continuous Source Current (Body Diode)	APT4016BN		31	Amps
		APT4018BN		29	
I_{SM}	Pulsed Source Current ^① (Body Diode)	APT4016BN		124	Amps
		APT4018BN		116	
V_{SD}	Diode Forward Voltage ^② ($V_{GS} = 0V, I_S = -I_D [\text{Cont.}]$)			1.3	Volts
t_{rr}	Reverse Recovery Time ($I_S = -I_D [\text{Cont.}], di_S/dt = 100A/\mu s$)		350	700	ns
Q_{rr}	Reverse Recovery Charge ($I_S = -I_D [\text{Cont.}], di_S/dt = 100A/\mu s$)		4.5	9	μC

SAFE OPERATING AREA CHARACTERISTICS

Symbol	Characteristic	Test Conditions / Part Number	MIN	TYP	MAX	UNIT
SOA1	Safe Operating Area	$V_{DS} = 0.4 V_{DSS}, I_{DS} = P_D / 0.4 V_{DSS}, t = 1\text{ Sec.}$	360			Watts
SOA2	Safe Operating Area	$I_{DS} = I_D [\text{Cont.}], V_{DS} = P_D / I_D [\text{Cont.}], t = 1\text{ Sec.}$	360			
I_{LM}	Inductive Current Clamped	APT4016BN	124			Amps
		APT4018BN	116			

① Repetitive Rating: Pulse width limited by maximum junction temperature. See Transient Thermal Impedance Curve. (Fig.1)

② Pulse Test: Pulse width < 380 μs , Duty Cycle < 2%

③ See MIL-STD-750 Method 3471

APT Reserves the right to change, without notice, the specifications and information contained herein.

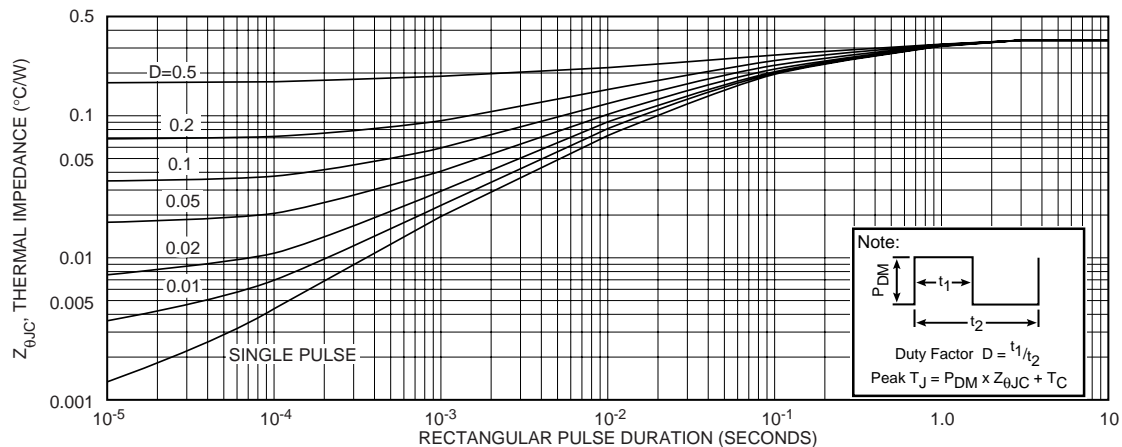

FIGURE 1, MAXIMUM EFFECTIVE TRANSIENT THERMAL IMPEDANCE, JUNCTION-TO-CASE vs PULSE DURATION

APT4016/4018BN

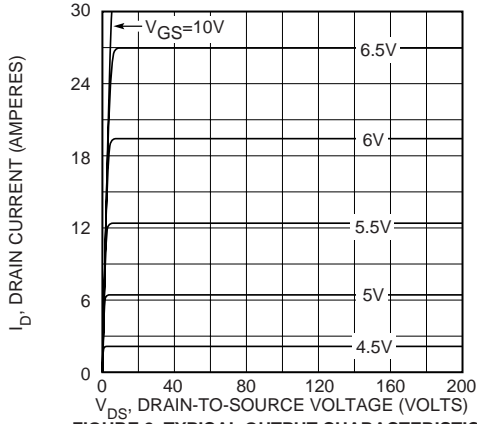

FIGURE 2, TYPICAL OUTPUT CHARACTERISTICS

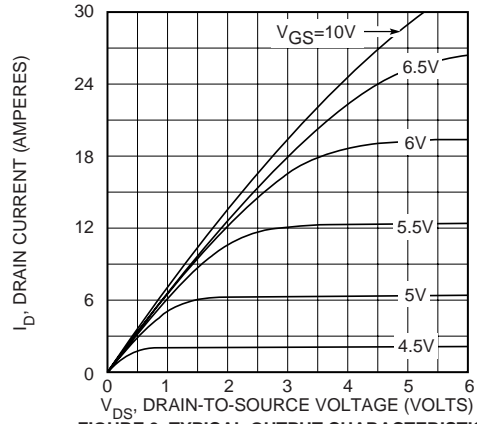

FIGURE 3, TYPICAL OUTPUT CHARACTERISTICS

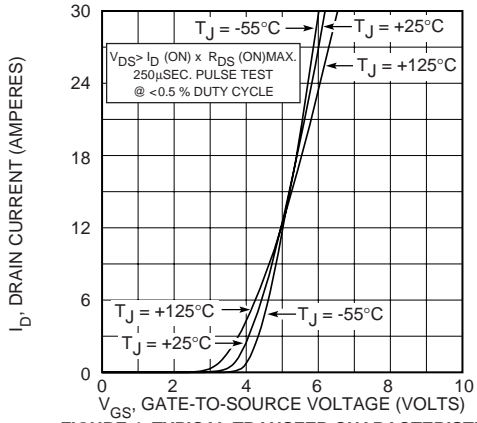

FIGURE 4, TYPICAL TRANSFER CHARACTERISTICS

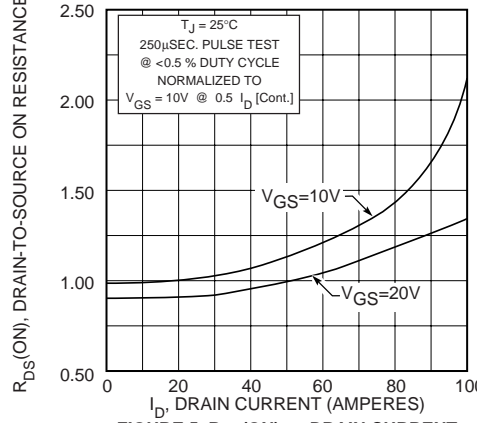

FIGURE 5, $R_{DS(ON)}$ vs DRAIN CURRENT

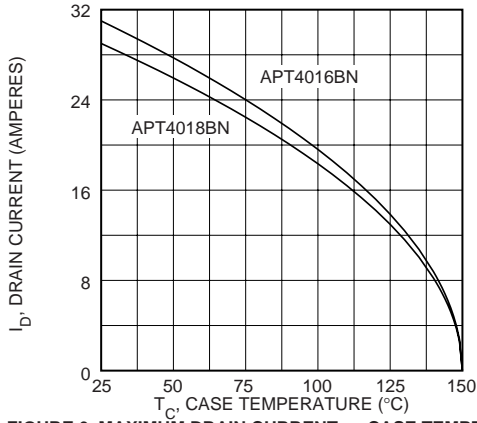

FIGURE 6, MAXIMUM DRAIN CURRENT vs CASE TEMPERATURE

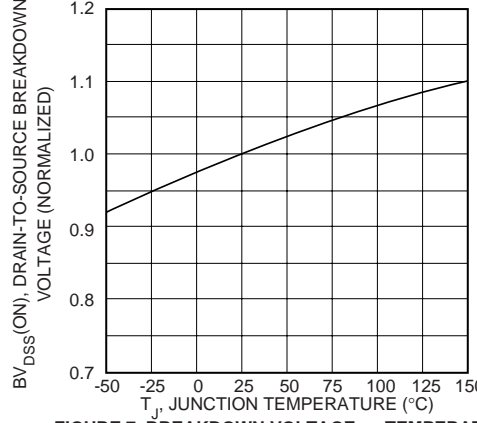

FIGURE 7, BREAKDOWN VOLTAGE vs TEMPERATURE

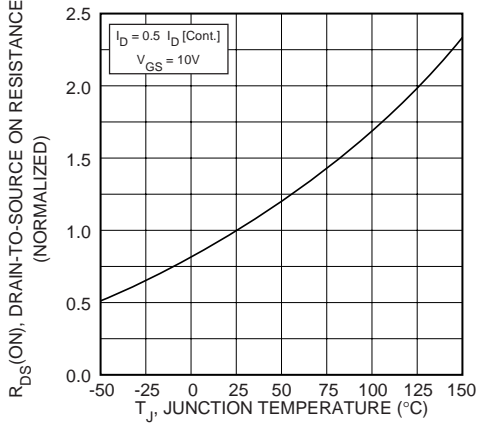

FIGURE 8, ON-RESISTANCE vs. TEMPERATURE

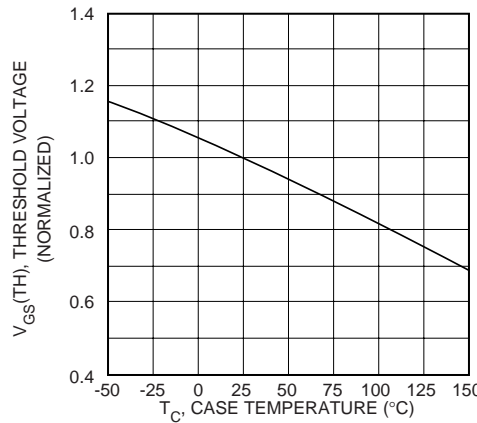

FIGURE 9, THRESHOLD VOLTAGE vs TEMPERATURE

APT4016/4018BN

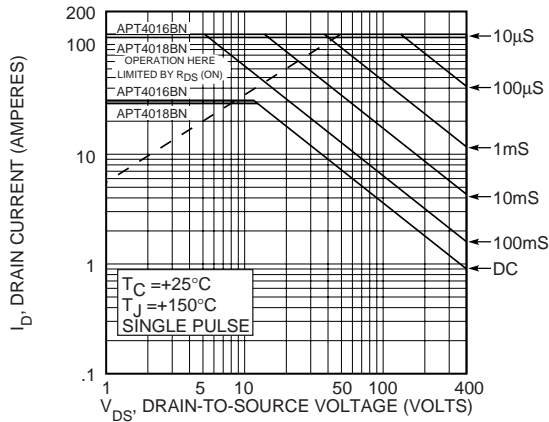

FIGURE 10, MAXIMUM SAFE OPERATING AREA

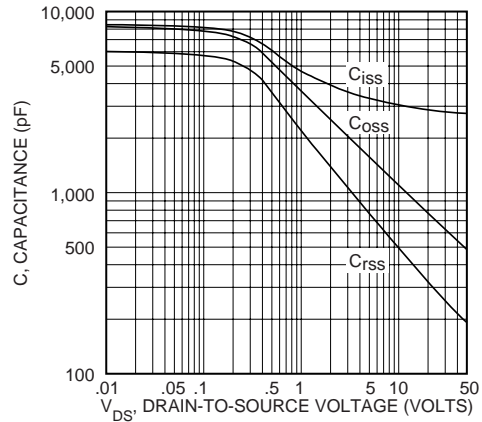

FIGURE 11, TYPICAL CAPACITANCE vs DRAIN-TO-SOURCE VOLTAGE

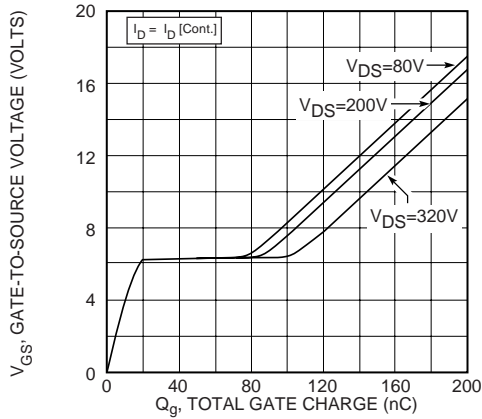

FIGURE 12, GATE CHARGES vs GATE-TO-SOURCE VOLTAGE

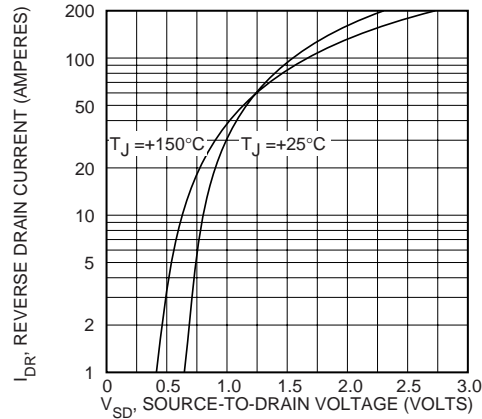
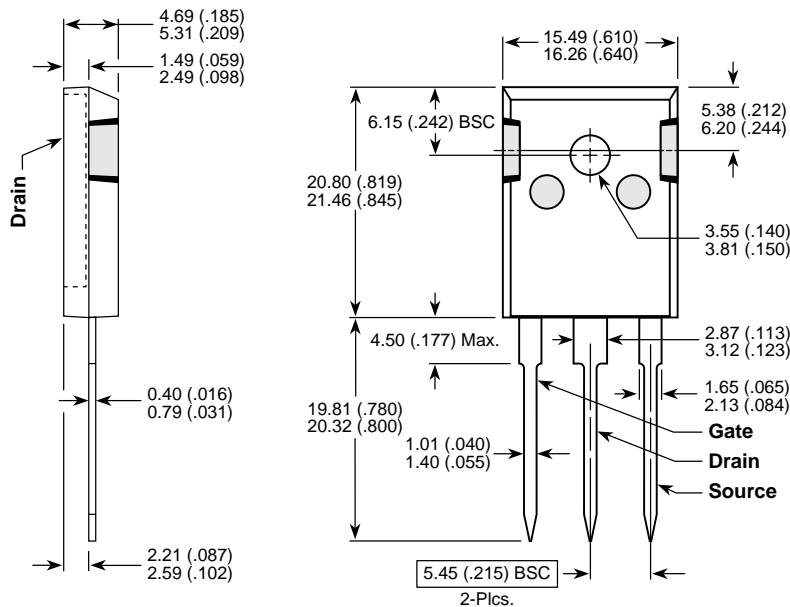

FIGURE 13, TYPICAL SOURCE-DRAIN DIODE FORWARD VOLTAGE

TO-247AD Package Outline



Dimensions in Millimeters and (Inches)