

SANYO	No.3026	2SA1706/2SC4486
		PNP/NPN Epitaxial Planar Silicon Transistors High-Current Switching Applications

Applications

- Voltage regulators, relay drivers, lamp drivers.

Features

- Adoption of FBET, MBIT processes.
- Large current capacity and wide ASO.
- Low collector-to-emitter saturation voltage.
- Fast switching speed.

() : 2SA1706

Absolute Maximum Ratings at Ta = 25°C

			unit
Collector to Base Voltage	V _{CBO}	(-)60	V
Collector to Emitter Voltage	V _{CEO}	(-)50	V
Emitter to Base Voltage	V _{EBO}	(-)6	V
Collector Current	I _C	(-)2	A
Collector Current(Pulse)	I _{CP}	(-)4	A
Collector Dissipation	P _C	1	W
Junction Temperature	T _j	150	°C
Storage Temperature	T _{stg}	-55 to +150	°C

Electrical Characteristics at Ta = 25°C

			min	typ	max	unit
Collector Cutoff Current	I _{CBO}	V _{CB} = (-)50V, I _E = 0			(-)100	nA
Emitter Cutoff Current	I _{EBO}	V _{EB} = (-)4V, I _C = 0			(-)100	nA
DC Current Gain	h _{FE} (1)	V _{CE} = (-)2V, I _C = (-)100mA	100*		400*	
	h _{FE} (2)	V _{CE} = (-)2V, I _C = (-)1.5A	40			
Gain-Bandwidth Product	f _T	V _{CE} = (-)10V, I _C = (-)50mA		150		MHz
C-E Saturation Voltage	V _{CE(sat)}	I _C = (-)1A, I _B = (-)50mA	(-0.3)0.15		(-0.7)0.4	V
B-E Saturation Voltage	V _{BE(sat)}	I _C = (-)1A, I _B = (-)50mA	(-)0.9		(-)1.2	V
Output Capacitance	c _{ob}	V _{CB} = (-)10V, f = 1MHz	(22)12			pF

Continued on next page.

* : The 2SA1706/2SC4486 are classified by 100mA h_{FE} as follows :

100 R 200	140 S 280	200 T 400
-----------	-----------	-----------

Package Dimensions 2064
(unit: mm)

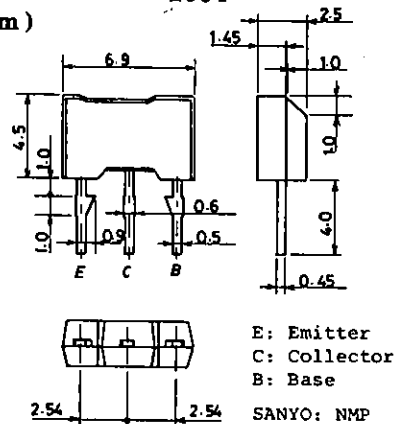

Continued from preceding page.

			min	typ	max	unit
C-B Breakdown Voltage	$V_{(BR)CBO}$	$I_C = (-)10\mu A, I_E = 0$	(-)60			V
C-E Breakdown Voltage	$V_{(BR)CEO}$	$I_C = (-)1mA, R_{BE} = \infty$	(-)50			V
E-B Breakdown Voltage	$V_{(BR)EBO}$	$I_E = (-)10\mu A, I_C = 0$	(-)6			V
Turn-ON Time	t_{on}	See specified Test Circuit.		60		ns
Storage Time	t_{stg}	∕		(450)550		ns
Fall Time	t_f	∕		30		ns

Switching Time Test Circuit

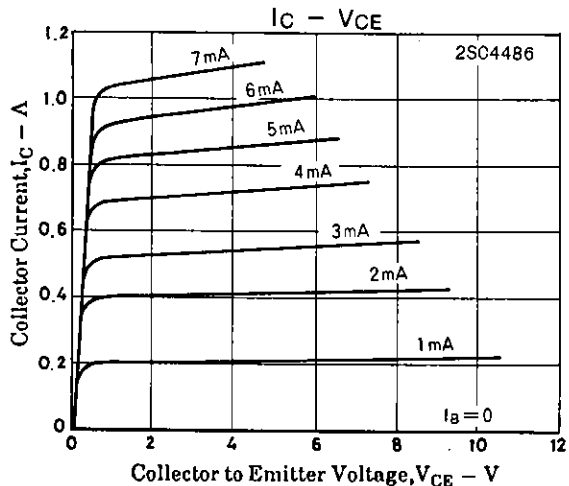
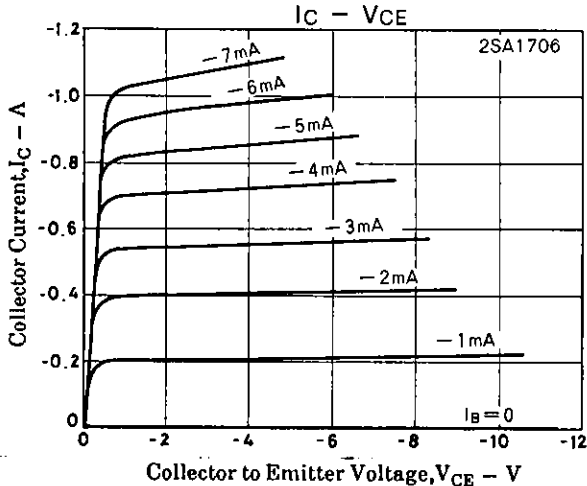
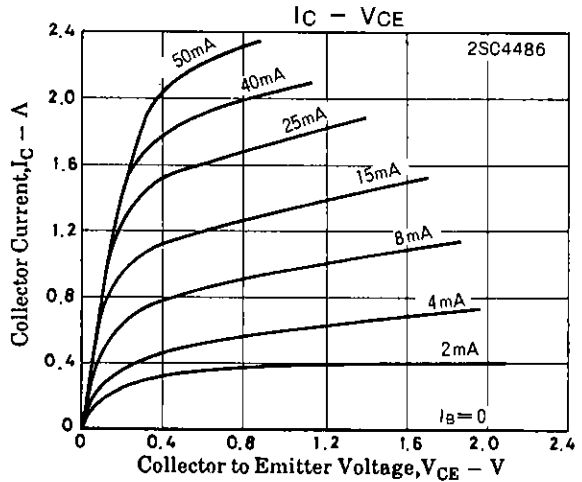
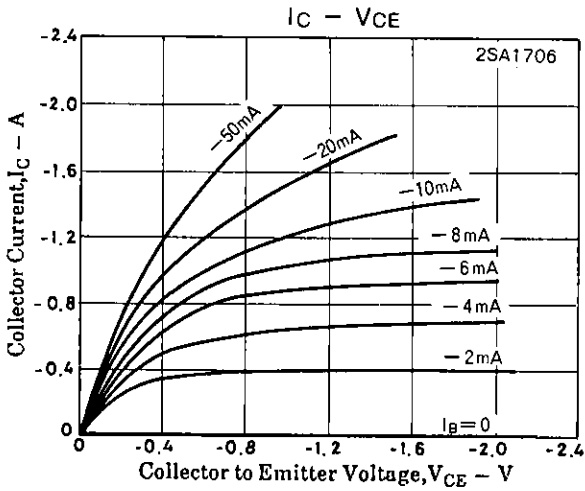
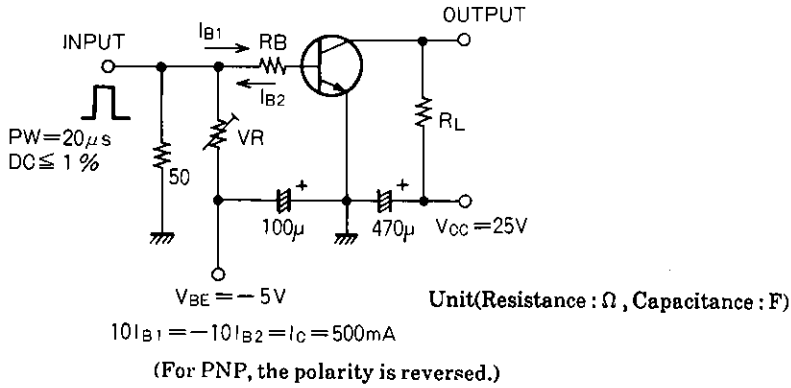

2SA1706/2SC4486

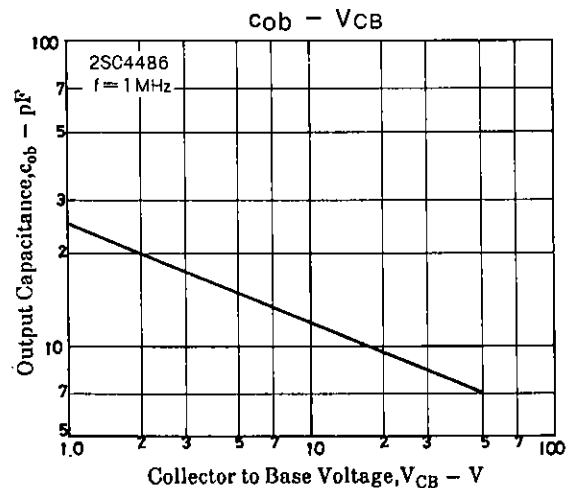
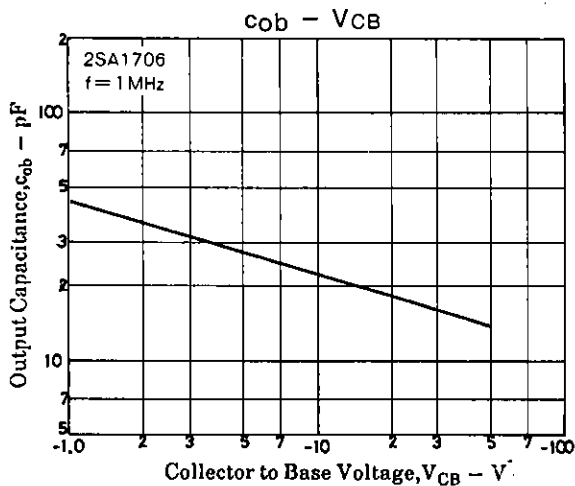
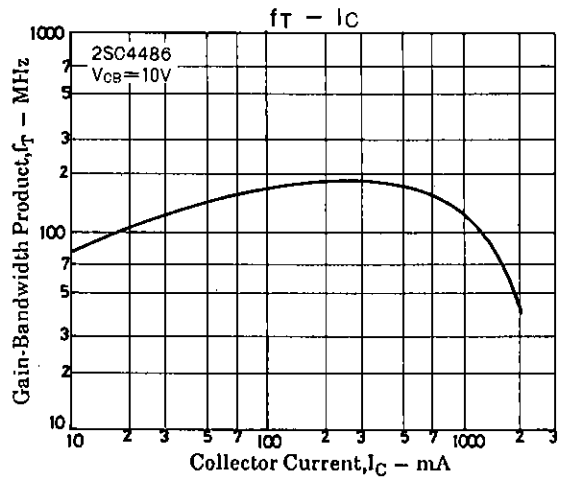
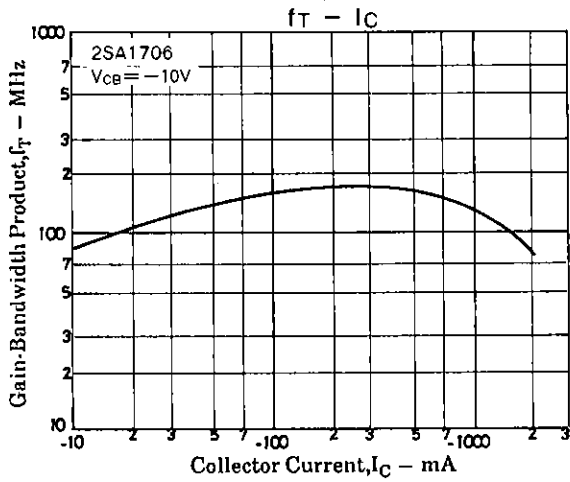
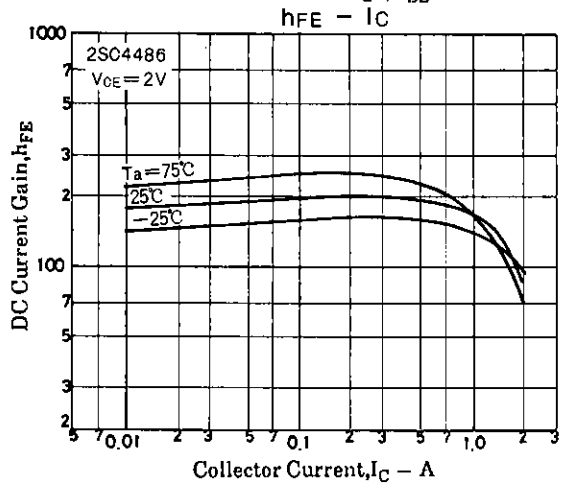
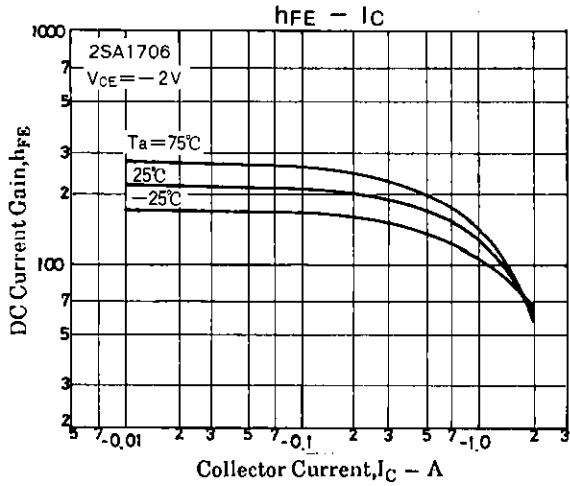
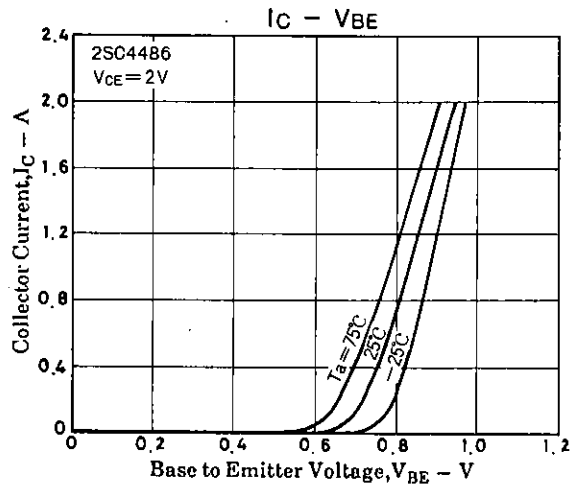
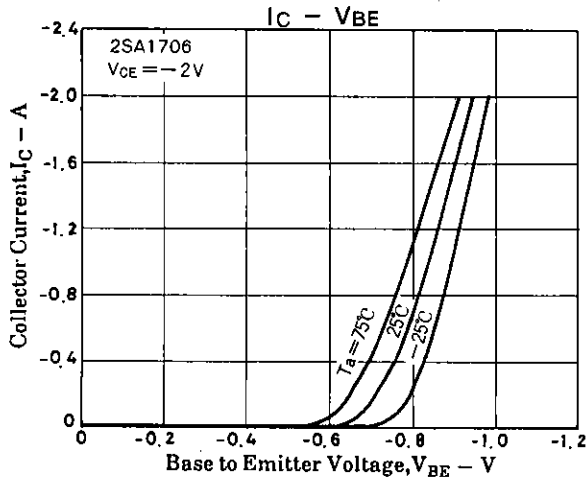

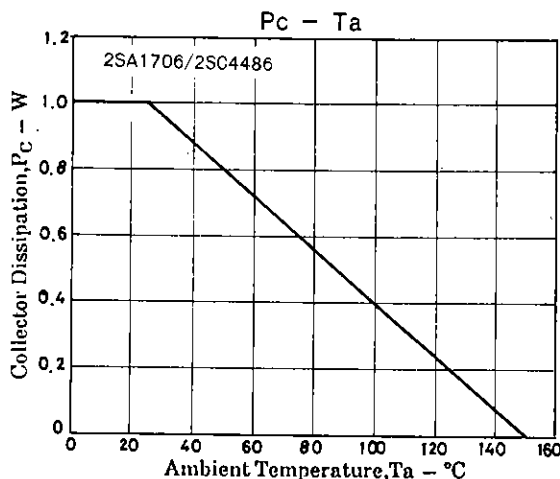
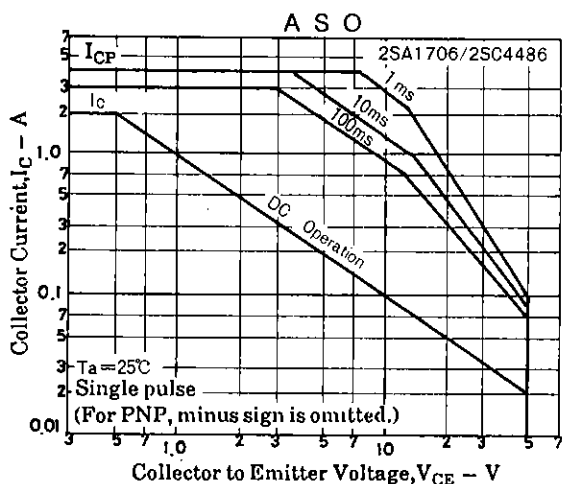
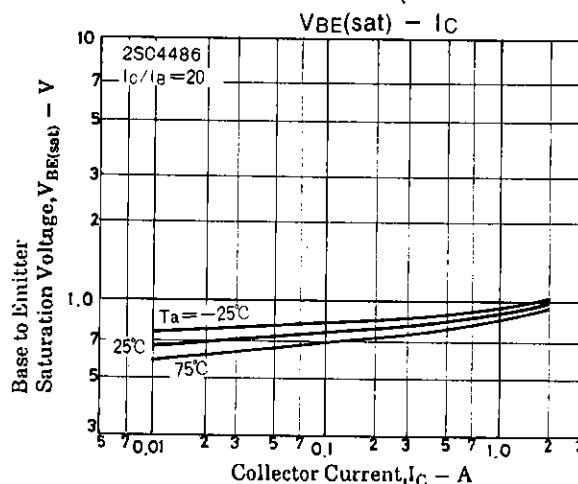
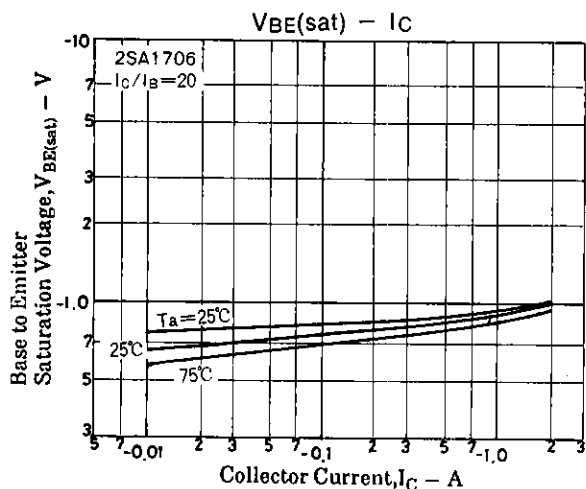
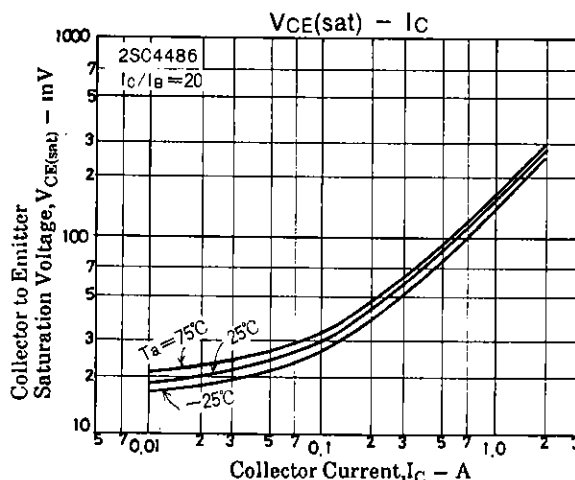
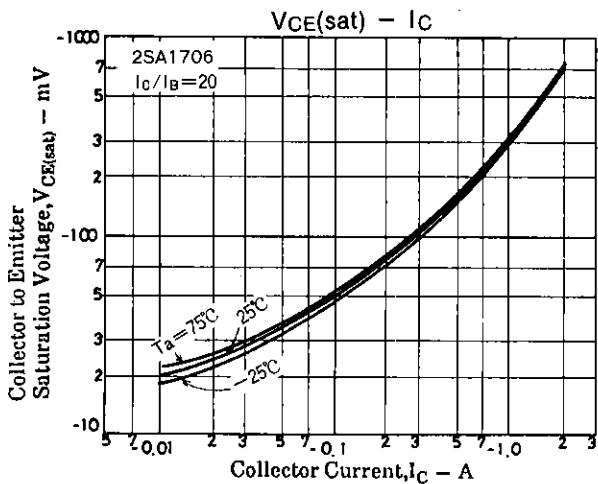

■ No products described or contained herein are intended for use in surgical implants, life-support systems, aerospace equipment, nuclear power control systems, vehicles, disaster/crime-prevention equipment and the like, the failure of which may directly or indirectly cause injury, death or property loss.

■ Anyone purchasing any products described or contained herein for an above-mentioned use shall:

- ① Accept full responsibility and indemnify and defend SANYO ELECTRIC CO., LTD., its affiliates, subsidiaries and distributors and all their officers and employees, jointly and severally, against any and all claims and litigation and all damages, cost and expenses associated with such use;
- ② Not impose any responsibility for any fault or negligence which may be cited in any such claim or litigation on SANYO ELECTRIC CO., LTD., its affiliates, subsidiaries and distributors or any of their officers and employees jointly or severally.

■ Information (including circuit diagrams and circuit parameters) herein is for example only; it is not guaranteed for volume production. SANYO believes information herein is accurate and reliable, but no guarantees are made or implied regarding its use or any infringements of intellectual property rights or other rights of third parties.