



**Höchstzulässige Werte / Maximum rated values**

**Elektrische Eigenschaften / Electrical properties**

Kollektor-Emitter-Sperrspannung collector-emitter voltage		$V_{CES}$	600	V
Kollektor-Dauergleichstrom DC-collector current	$T_C= 45^{\circ}C$	$I_{C,nom.}$	200	A
	$T_C= 25^{\circ}C$	$I_C$	226	A
Periodischer Kollektor Spitzenstrom repetitive peak collector current	$t_p= 1ms, T_C= 45^{\circ}C$	$I_{CRM}$	400	A
Gesamt-Verlustleistung total power dissipation	$T_C= 25^{\circ}C, Transistor$	$P_{tot}$	700	W
Gate-Emitter-Spitzenspannung gate-emitter peak voltage		$V_{GES}$	+/- 20V	V
Dauergleichstrom DC forward current		$I_F$	200	A
Periodischer Spitzenstrom repetitive peak forw. current	$t_p= 1ms$	$I_{FRM}$	400	A
Grenzlastintegral der Diode $I^2t$ - value, Diode	$V_R= 0V, t_p= 10ms, T_{vj}= 125^{\circ}C$	$I^2t$	8.450	A <sup>2</sup> s
Isolations-Prüfspannung insulation test voltage	RMS, f= 50Hz, t= 1min.	$V_{ISOL}$	2,5	kV

**Charakteristische Werte / Characteristic values**

**Transistor / Transistor**

			min.	typ.	max.	
Kollektor-Emitter Sättigungsspannung collector-emitter saturation voltage	$I_C= 200A, V_{GE}= 15V, T_{vj}= 25^{\circ}C$	$V_{CE sat}$	-	1,95	2,45	V
	$I_C= 200A, V_{GE}= 15V, T_{vj}= 125^{\circ}C$		-	2,20	-	V
Gate-Schwellenspannung gate threshold voltage	$I_C= 4,0mA, V_{CE}= V_{GE}, T_{vj}= 25^{\circ}C$	$V_{GE(th)}$	4,5	5,5	6,5	V
Eingangskapazität input capacitance	f= 1MHz, $T_{vj}= 25^{\circ}C, V_{CE}= 25V, V_{GE}= 0V$	$C_{ies}$	-	9	-	nF
Rückwirkungskapazität reverse transfer capacitance	f= 1MHz, $T_{vj}= 25^{\circ}C, V_{CE}= 25V, V_{GE}= 0V$	$C_{res}$	-	0,8	-	nF
Kollektor-Emitter Reststrom collector-emitter cut-off current	$V_{CE}= 600V, V_{GE}= 0V, T_{vj}= 25^{\circ}C$	$I_{CES}$	-	1	500	$\mu A$
	$V_{CE}= 600V, V_{GE}= 0V, T_{vj}= 125^{\circ}C$		-	1	-	mA
Gate-Emitter Reststrom gate-emitter leakage current	$V_{CE}= 0V, V_{GE}= 20V, T_{vj}= 25^{\circ}C$	$I_{GES}$	-	-	400	nA

prepared by: Andreas Vetter	date of publication: 2000-04-26
approved by: Michael Hornkamp	revision: 1



**Charakteristische Werte / Characteristic values**

**Transistor / Transistor**

			min.	typ.	max.	
Einschaltverzögerungszeit (ind. Last) turn on delay time (inductive load)	$I_C= 200A, V_{CC}= 300V$	$t_{d,on}$	-	163	-	ns
	$V_{GE}= \pm 15V, R_G= 1,5\Omega, T_{vj}= 25^\circ C$ $V_{GE}= \pm 15V, R_G= 1,5\Omega, T_{vj}= 125^\circ C$		-	180	-	ns
Anstiegszeit (induktive Last) rise time (inductive load)	$I_C= 200A, V_{CC}= 300V$	$t_r$	-	43	-	ns
	$V_{GE}= \pm 15V, R_G= 1,5\Omega, T_{vj}= 25^\circ C$ $V_{GE}= \pm 15V, R_G= 1,5\Omega, T_{vj}= 125^\circ C$		-	49	-	ns
Abschaltverzögerungszeit (ind. Last) turn off delay time (inductive load)	$I_C= 200A, V_{CC}= 300V$	$t_{d,off}$	-	253	-	ns
	$V_{GE}= \pm 15V, R_G= 1,5\Omega, T_{vj}= 25^\circ C$ $V_{GE}= \pm 15V, R_G= 1,5\Omega, T_{vj}= 125^\circ C$		-	285	-	ns
Fallzeit (induktive Last) fall time (inductive load)	$I_C= 200A, V_{CC}= 300V$	$t_f$	-	33	-	ns
	$V_{GE}= \pm 15V, R_G= 1,5\Omega, T_{vj}= 25^\circ C$ $V_{GE}= \pm 15V, R_G= 1,5\Omega, T_{vj}= 125^\circ C$		-	41	-	ns
Einschaltverlustenergie pro Puls turn-on energy loss per pulse	$I_C= 200A, V_{CC}= 300V, V_{GE}= 15V$ $R_G= 1,5\Omega, T_{vj}= 125^\circ C, L_\sigma= 15nH$	$E_{on}$	-	4,6	-	mJ
Abschaltverlustenergie pro Puls turn-off energy loss per pulse	$I_C= 200A, V_{CC}= 300V, V_{GE}= 15V$ $R_G= 1,5\Omega, T_{vj}= 125^\circ C, L_\sigma= 15nH$	$E_{off}$	-	6,3	-	mJ
Kurzschlußverhalten SC Data	$t_p \leq 10\mu sec, V_{GE} \leq 15V$ $T_{vj} \leq 125^\circ C, V_{CC}= 360V, V_{CEmax}= V_{CES} - L_{\sigma CE} \cdot di/dt$	$I_{SC}$	-	900	-	A
Modulinduktivität stray inductance module		$L_{\sigma CE}$	-	28	-	nH
Modul-Leitungswiderstand, Anschlüsse - Chip lead resistance, terminals - chip	$T_c= 25^\circ C$	$R_{CC+EE}$	-	1,8	-	mΩ

**Charakteristische Werte / Characteristic values**

**Diode / Diode**

			min.	typ.	max.	
Durchlaßspannung forward voltage	$I_F= 200A, V_{GE}= 0V, T_{vj}= 25^\circ C$	$V_F$	-	1,25	1,6	V
	$I_F= 200A, V_{GE}= 0V, T_{vj}= 125^\circ C$		-	1,20	-	V
Rückstromspitze peak reverse recovery current	$I_F= 200A, -di_F/dt= 4000A/\mu s$	$I_{RM}$	-	154	-	A
	$V_R= 300V, V_{GE}= -10V, T_{vj}= 25^\circ C$ $V_R= 300V, V_{GE}= -10V, T_{vj}= 125^\circ C$		-	188	-	A
Sperrverzögerungsladung recovered charge	$I_F= 200A, -di_F/dt= 4000A/\mu s$	$Q_r$	-	12,1	-	μC
	$V_R= 300V, V_{GE}= -10V, T_{vj}= 25^\circ C$ $V_R= 300V, V_{GE}= -10V, T_{vj}= 125^\circ C$		-	19,7	-	μC
Abschaltenergie pro Puls reverse recovery energy	$I_F= 200A, -di_F/dt= 4000A/\mu s$	$E_{rec}$	-	-	-	mJ
	$V_R= 300V, V_{GE}= -10V, T_{vj}= 25^\circ C$ $V_R= 300V, V_{GE}= -10V, T_{vj}= 125^\circ C$		-	4,1	-	mJ

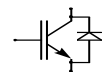

**Thermische Eigenschaften / Thermal properties**

			min.	typ.	max.	
Innerer Wärmewiderstand thermal resistance, junction to case	Transistor / transistor, DC	$R_{thJC}$	-	-	0,18	K/W
	Diode / diode, DC		-	-	0,32	K/W
Übergangs-Wärmewiderstand thermal resistance, case to heatsink	pro Modul / per module $\lambda_{Paste}= 1W/m^*K$ / $\lambda_{grease}= 1W/m^*K$	$R_{thCK}$	-	0,01	-	K/W
Höchstzulässige Sperrschichttemperatur maximum junction temperature		$T_{vj}$	-	-	150	°C
Betriebstemperatur operation temperature		$T_{op}$	-40	-	125	°C
Lagertemperatur storage temperature		$T_{stg}$	-40	-	125	°C

**Mechanische Eigenschaften / Mechanical properties**

Gehäuse, siehe Anlage case, see appendix						
Innere Isolation internal insulation				Al <sub>2</sub> O <sub>3</sub>		
CTI comperative tracking index				225		
Anzugsdrehmoment f. mech. Befestigung mounting torque	Schraube M5 screw M5	M	-15	4	+15	Nm %
Gewicht weight		G		310		g

Mit dieser technischen Information werden Halbleiterbauelemente spezifiziert, jedoch keine Eigenschaften zugesichert. Sie gilt in Verbindung mit den zugehörigen Technischen Erläuterungen.

This technical information specifies semiconductor devices but promises no characteristics. It is valid in combination with the belonging technical notes.



**Ausgangskennlinie (typisch)**  
**Output characteristic (typical)**

**$I_C = f(V_{CE})$**   
 **$V_{GE} = 15V$**

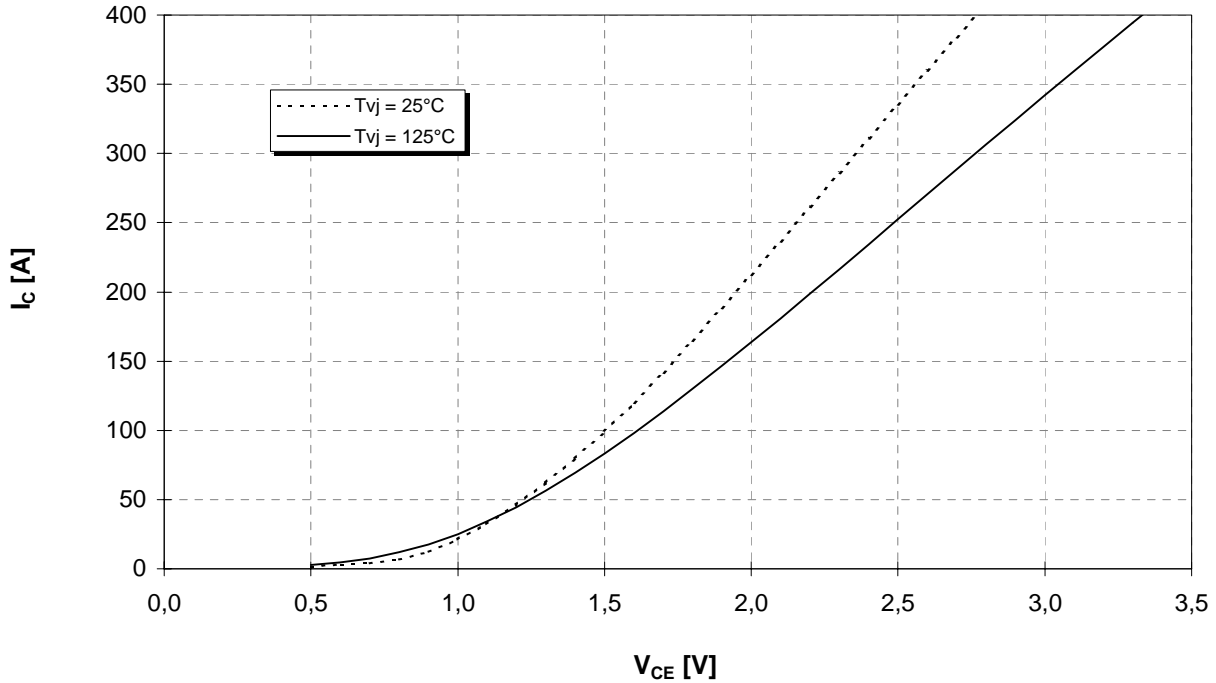

**Ausgangskennlinienfeld (typisch)**  
**Output characteristic (typical)**

**$I_C = f(V_{CE})$**   
 **$T_{vj} = 125^\circ C$**

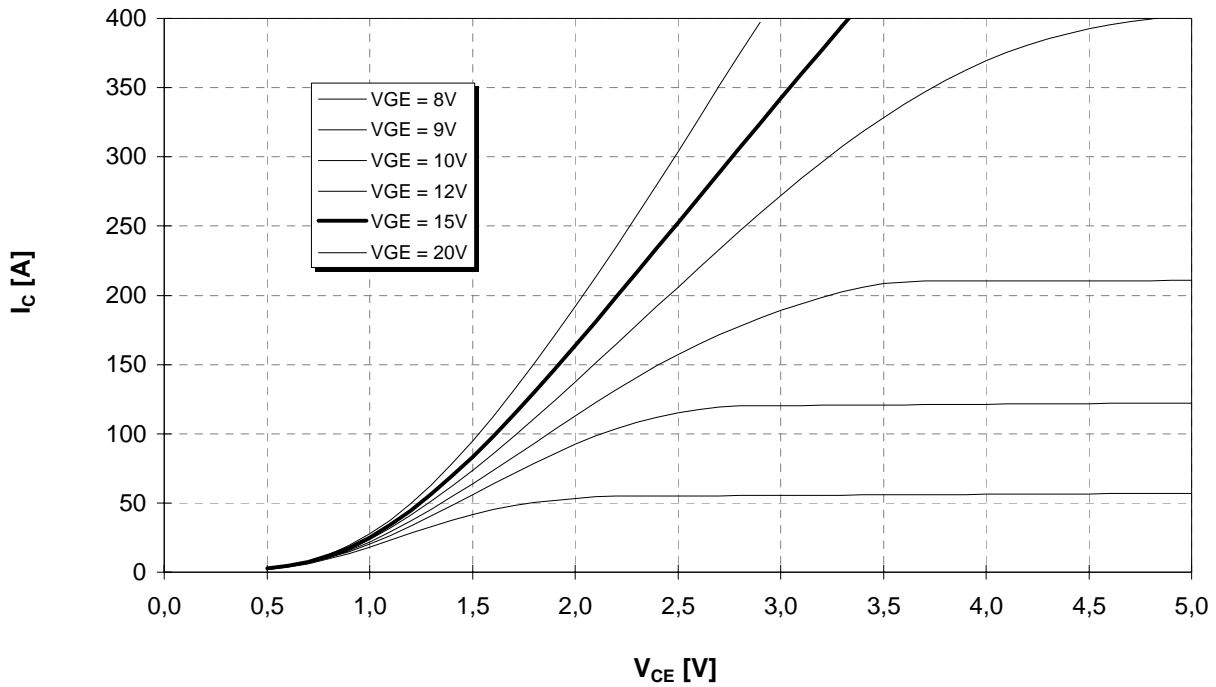



**Übertragungscharakteristik (typisch)**  
**Transfer characteristic (typical)**

$I_C = f(V_{GE})$   
 $V_{CE} = 20V$

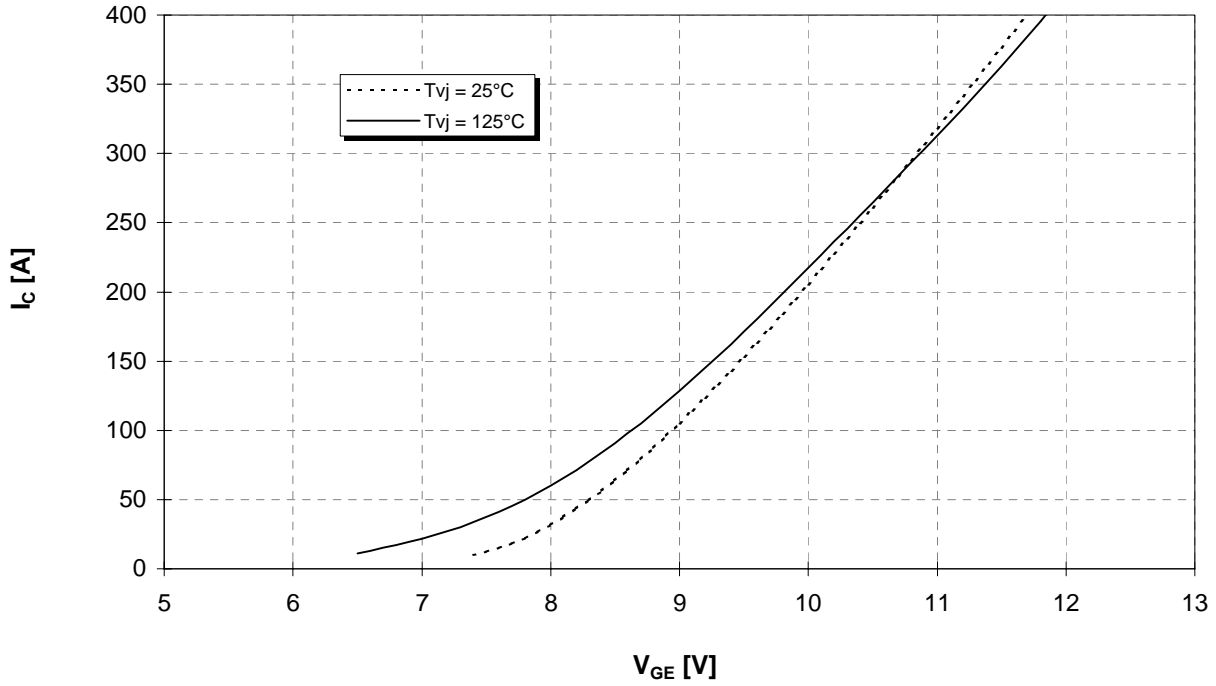

**Durchlaßkennlinie der Inversdiode (typisch)**  
**Forward characteristic of inverse diode (typical)**

$I_F = f(V_F)$

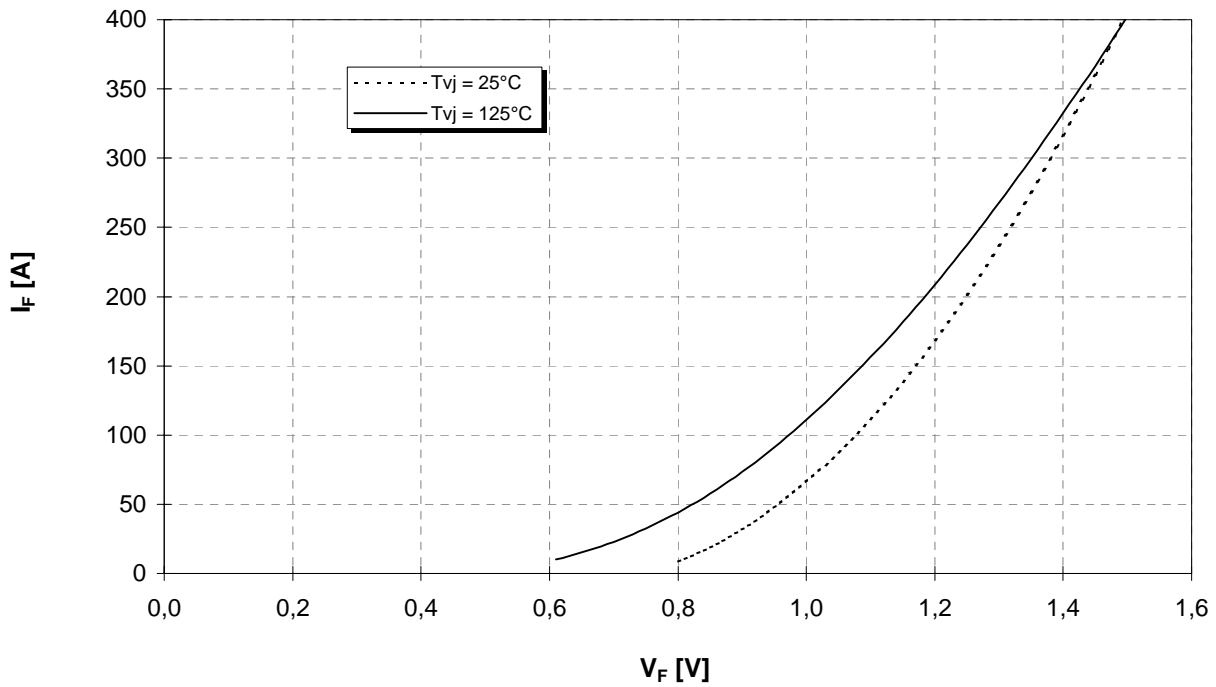



**Schaltverluste (typisch)**  
**Switching losses (typical)**

$E_{on} = f(I_c), E_{off} = f(I_c), E_{rec} = f(I_c)$

$R_{G,on} = 1,5\Omega, R_{G,off} = 1,5\Omega, V_{CC} = 300V, T_{vj} = 125^\circ C$

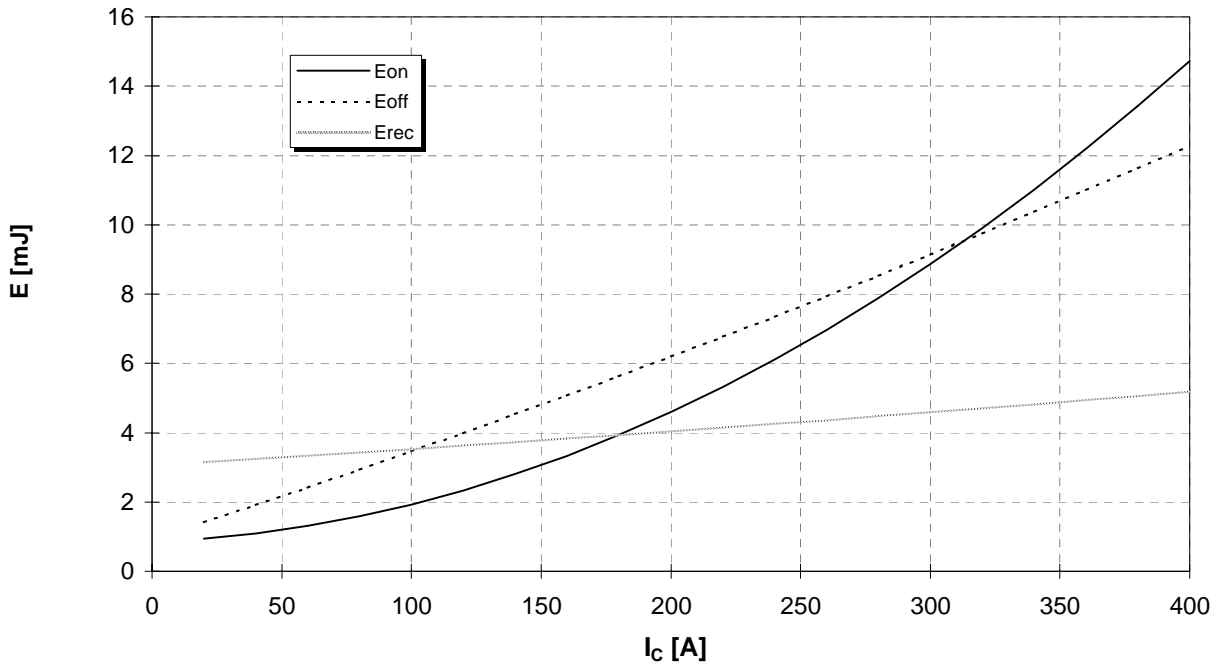

**Schaltverluste (typisch)**  
**Switching losses (typical)**

$E_{on} = f(R_G), E_{off} = f(R_G), E_{rec} = f(R_G)$

$I_c = 200A, V_{CE} = 300V, T_{vj} = 125^\circ C$

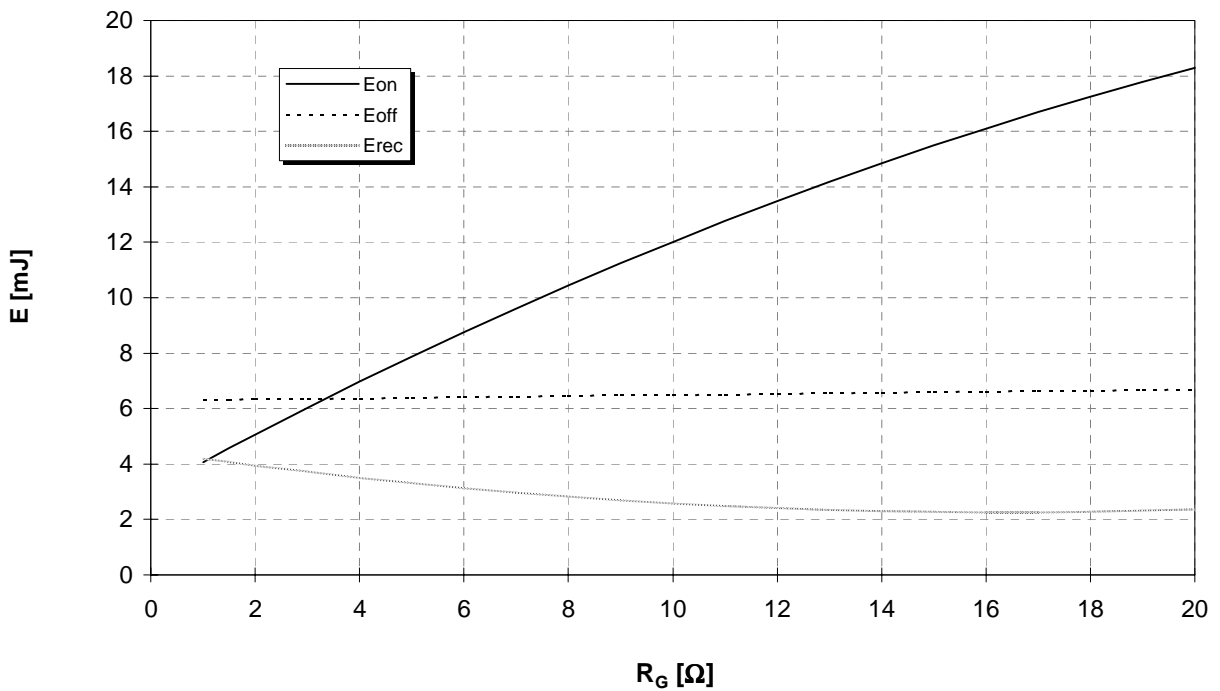

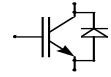

**Transienter Wärmewiderstand**  
**Transient thermal impedance**

$Z_{thJC} = f(t)$

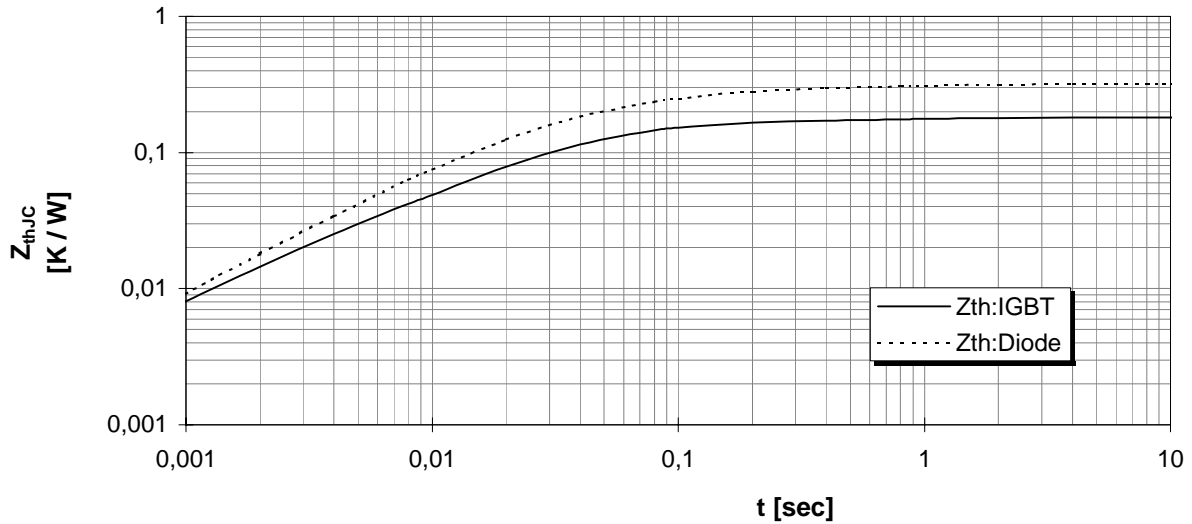

i	1	2	3	4
$r_i$ [K/kW] : IGBT	7,6	94,3	63,4	14,6
$\tau_i$ [sec] : IGBT	0,0018	0,0240	0,0651	0,6626
$r_i$ [K/kW] : Diode	112,8	108,2	67,9	31,1
$\tau_i$ [sec] : Diode	0,0487	0,0169	0,1069	0,9115

**Sicherer Arbeitsbereich (RBSOA)**

**Reverse bias safe operation area (RBSOA)**

$V_{GE} = +15V, R_{G,off} = 1,5\Omega, T_{vj} = 125^\circ C$

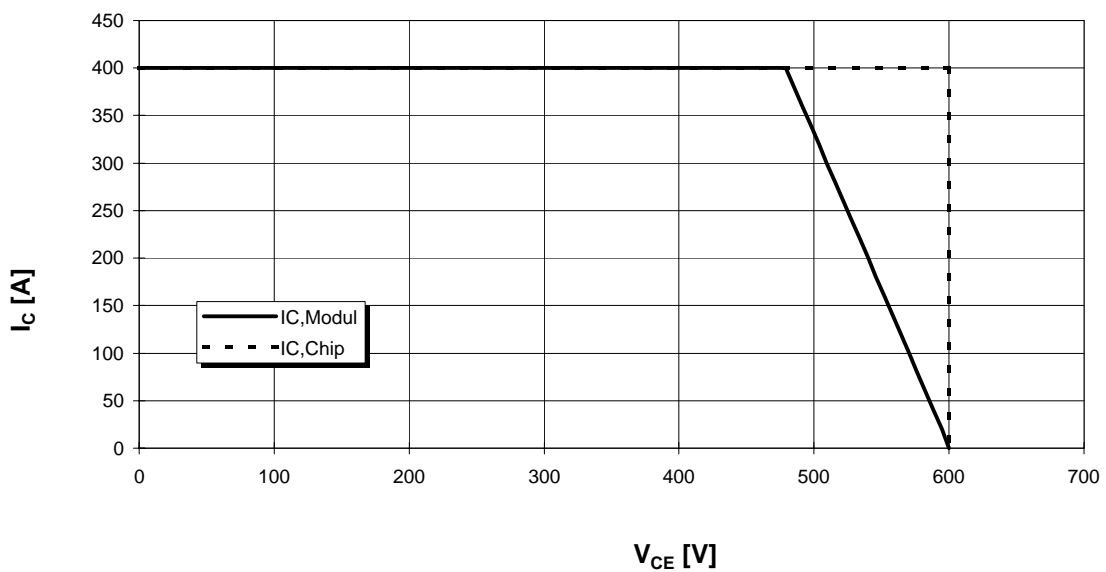



Gehäusemaße / Schaltbild  
Package outline / Circuit diagram

Econo 3

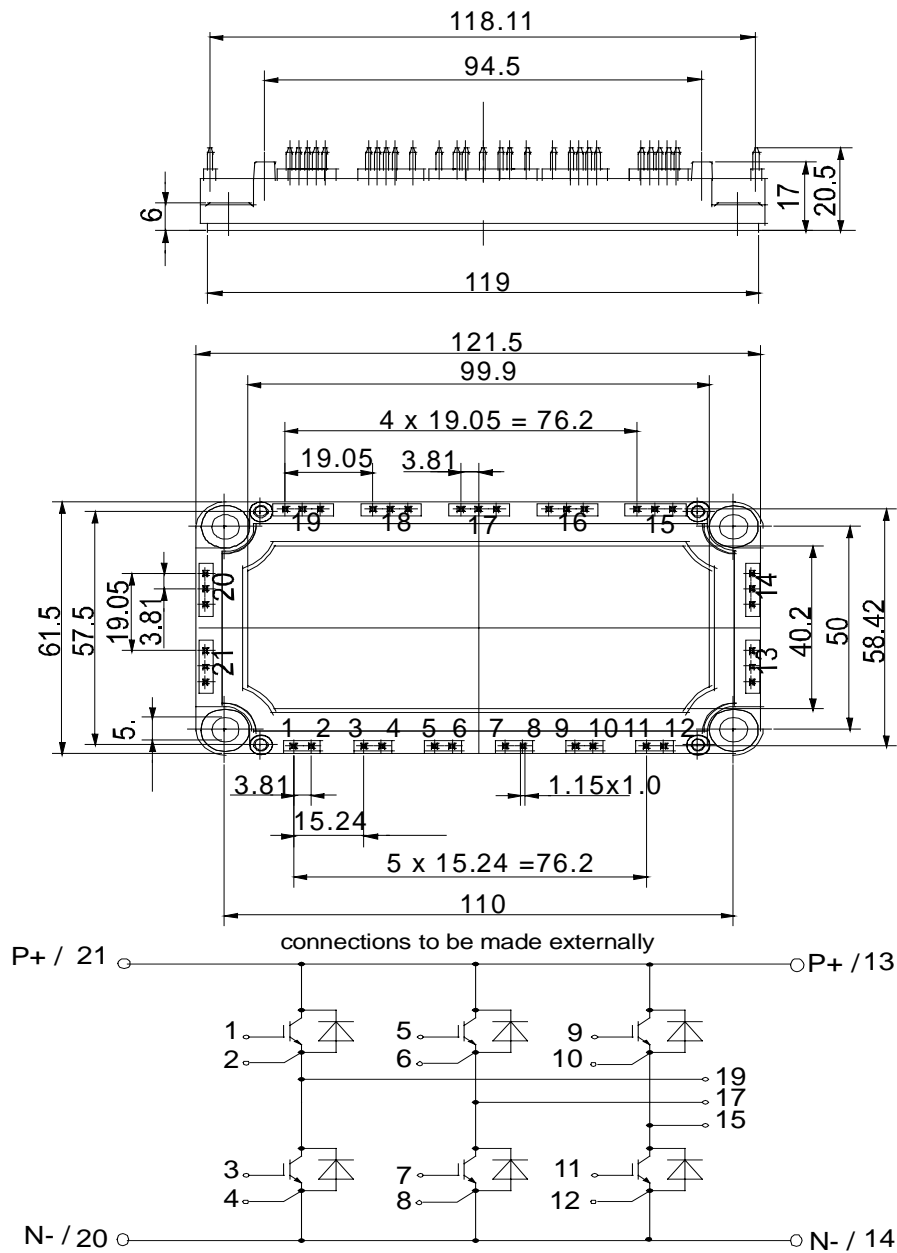

IS8



## **Terms & Conditions of Usage**

### **Attention**

The present product data is exclusively subscribed to technically experienced staff. This Data Sheet is describing the specification of the products for which a warranty is granted exclusively pursuant the terms and conditions of the supply agreement. There will be no guarantee of any kind for the product and its specifications. Changes to the Data Sheet are reserved.

You and your technical departments will have to evaluate the suitability of the product for the intended application and the completeness of the product data with respect to such application. Should you require product information in excess of the data given in the Data Sheet, please contact your local Sales Office via "[www.eupec.com / sales & contact](http://www.eupec.com / sales & contact)".

### **Warning**

Due to technical requirements the products may contain dangerous substances. For information on the types in question please contact your local Sales Office via "[www.eupec.com / sales & contact](http://www.eupec.com / sales & contact)".