

## LP2982 Micropower SOT, 50 mA Ultra Low-Dropout Regulator

### General Description

The LP2982 is a 50 mA, fixed-output voltage regulator designed to provide ultra low dropout and lower noise in battery powered applications.

Using an optimized VIP™ (Vertically Integrated PNP) process, the LP2982 delivers unequaled performance in all specifications critical to battery-powered designs:

**Dropout Voltage:** Typically 120 mV @ 50 mA load, and 7 mV @ 1 mA load.

**Ground Pin Current:** Typically 375  $\mu$ A @ 50 mA load, and 80  $\mu$ A @ 1 mA load.

**Sleep Mode:** Less than 1  $\mu$ A quiescent current when on/off pin is pulled low.

**Smallest Possible Size:** SOT-23 package uses absolute minimum of board space.

**Precision Output:** 1.0% tolerance output voltages available (A grade).

**Low Noise:** By adding an external bypass capacitor, output noise can be reduced to 30  $\mu$ V (typical).

Ten output voltage versions, from 2.5V to 5.0V, are available as standard products.

### Features

- Ultra low dropout voltage
- Guaranteed 50 mA output current
- Typical dropout voltage 180 mV @ 80 mA
- Smallest possible size (SOT-23 Package)
- Requires minimum external components
- < 1  $\mu$ A quiescent current when shutdown
- Low ground pin current at all loads
- Output voltage accuracy 1.0% (A Grade)
- High peak current capability (150 mA typical)
- Wide supply voltage range (16V max)
- Low  $Z_{OUT}$  0.3 $\Omega$  typical (10 Hz to 1 MHz)
- Overtemperature/overcurrent protection
- -40°C to +125°C junction temperature range
- Custom voltages available

### Applications

- Cellular Phone
- Palmtop/Laptop Computer
- Personal Digital Assistant (PDA)
- Camcorder, Personal Stereo, Camera

### Block Diagram

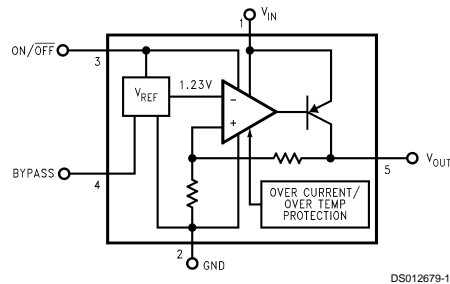

### Connection Diagram

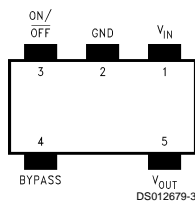

See NS Package Number MA05B

VIP™ is a trademark of National Semiconductor Corporation.

## Basic Application Circuit

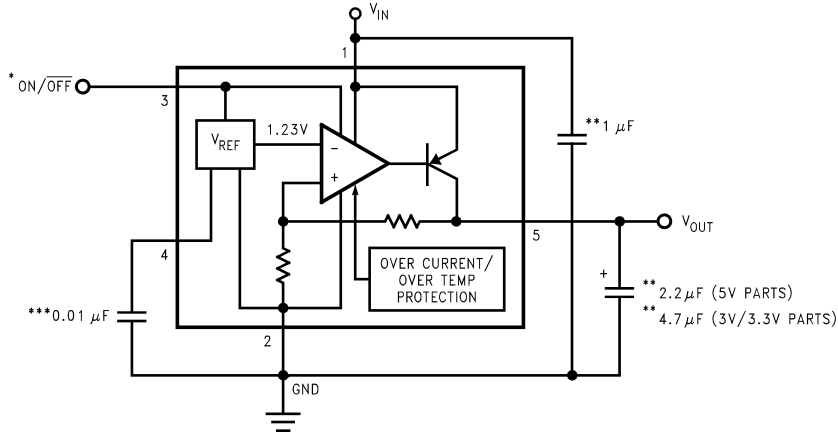

DS012679-2

\*ON/OFF input must be actively terminated. Tie to  $V_{IN}$  if this function is not to be used.

\*\*Minimum capacitance is shown to insure stability over full load current range. More capacitance provides superior dynamic performance (see Application Hints).

\*\*\*See Application Hints.

## Ordering Information

TABLE 1. Package Marking and Ordering Information

Output Voltage (V)	Grade	Order Information	Package Marking	Supplied as:
2.5	A	LP2982AIM5X-2.5	L58A	3k Units on Tape and Reel
2.5	A	LP2982AIM5-2.5	L58A	250 Units on Tape and Reel
2.5	STD	LP2982IM5X-2.5	L58B	3k Units on Tape and Reel
2.5	STD	LP2982IM5-2.5	L58B	250 Units on Tape and Reel
2.8	A	LP2982AIM5X-2.8	L60A	3k Units on Tape and Reel
2.8	A	LP2982AIM5-2.8	L60A	250 Units on Tape and Reel
2.8	STD	LP2982IM5X-2.8	L60B	3k Units on Tape and Reel
2.8	STD	LP2982IM5-2.8	L60B	250 Units on Tape and Reel
3.0	A	LP2982AIM5X-3.0	L20A	3k Units on Tape and Reel
3.0	A	LP2982AIM5-3.0	L20A	250 Units on Tape and Reel
3.0	STD	LP2982IM5X-3.0	L20B	3k Units on Tape and Reel
3.0	STD	LP2982IM5-3.0	L20B	250 Units on Tape and Reel
3.3	A	LP2982AIM5X-3.3	L19A	3k Units on Tape and Reel
3.3	A	LP2982AIM5-3.3	L19A	250 Units on Tape and Reel
3.3	STD	LP2982IM5X-3.3	L19B	3k Units on Tape and Reel
3.3	STD	LP2982IM5-3.3	L19B	250 Units on Tape and Reel
3.6	A	LP2982AIM5X-3.6	L0BA	3k Units on Tape and Reel
3.6	A	LP2982AIM5-3.6	L0BA	250 Units on Tape and Reel
3.6	STD	LP2982IM5X-3.6	L0BB	3k Units on Tape and Reel
3.6	STD	LP2982IM5-3.6	L0BB	250 Units on Tape and Reel
3.8	A	LP2982AIM5X-3.8	L76A	3k Units on Tape and Reel
3.8	A	LP2982AIM5-3.8	L76A	250 Units on Tape and Reel
3.8	STD	LP2982IM5X-3.8	L76B	3k Units on Tape and Reel
3.8	STD	LP2982IM5-3.8	L76B	250 Units on Tape and Reel
4.0	A	LP2982AIM5X-4.0	L29A	3k Units on Tape and Reel

## Ordering Information (Continued)

TABLE 1. Package Marking and Ordering Information (Continued)

Output Voltage (V)	Grade	Order Information	Package Marking	Supplied as:
4.0	A	LP2982AIM5-4.0	L29A	250 Units on Tape and Reel
4.0	STD	LP2982IM5X-4.0	L29B	3k Units on Tape and Reel
4.0	STD	LP2982IM5-4.0	L29B	250 Units on Tape and Reel
4.5	A	LP2982AIM5X-4.5	LA8A	3k Units on Tape and Reel
4.5	A	LP2982AIM5-4.5	LA8A	250 Units on Tape and Reel
4.5	STD	LP2982IM5X-4.5	LA8B	3k Units on Tape and Reel
4.5	STD	LP2982IM5-4.5	LA8B	250 Units on Tape and Reel
4.7	A	LP2982AIM5X-4.7	LOHA	3k Units on Tape and Reel
4.7	A	LP2982AIM5-4.7	LOHA	250 Units on Tape and Reel
4.7	STD	LP2982IM5X-4.7	LOHB	3k Units on Tape and Reel
4.7	STD	LP2982IM5-4.7	LOHB	250 Units on Tape and Reel
5.0	A	LP2982AIM5X-5.0	L18A	3k Units on Tape and Reel
5.0	A	LP2982AIM5-5.0	L18A	250 Units on Tape and Reel
5.0	STD	LP2982IM5X-5.0	L18B	3k Units on Tape and Reel
5.0	STD	LP2982IM5-5.0	L18B	250 Units on Tape and Reel

## Absolute Maximum Ratings (Note 1)

If Military/Aerospace specified devices are required, please contact the National Semiconductor Sales Office/Distributors for availability and specifications.

Storage Temperature Range	-65°C to +150°C
Operating Junction Temperature Range	-40°C to +125°C
Lead Temperature (Soldering, 5 sec.)	260°C
ESD Rating (Note 2)	2 kV

## Power Dissipation (Note 3)

Input Supply Voltage (Survival)	-0.3V to +16V	Internally Limited
Input Supply Voltage (Operating)	2.1V to +16V	
Shutdown Input Voltage (Survival)	-0.3V to +16V	
Output Voltage (Survival, (Note 4))	-0.3V to +9V	
I <sub>OUT</sub> (Survival)	Short Circuit Protected	
Input-Output Voltage (Survival, (Note 5))	-0.3V to +16V	

## Electrical Characteristics

Limits in standard typeface are for T<sub>J</sub> = 25°C, and limits in **boldface type** apply over the full operating temperature range. Unless otherwise specified: V<sub>IN</sub> = V<sub>O(NOM)</sub> + 1V, I<sub>L</sub> = 1 mA, C<sub>IN</sub> = 1 μF, C<sub>OUT</sub> = 4.7 μF, V<sub>ON/OFF</sub> = 2V.

Symbol	Parameter	Conditions	Typ	LP2982AI-X.X (Note 6)		LP2982I-X.X (Note 6)		Units
				Min	Max	Min	Max	
ΔV <sub>O</sub>	Output Voltage Tolerance	I <sub>L</sub> = 1 mA		-1.0	+1.0	-1.5	+1.5	%V <sub>NOM</sub>
		1 mA < I <sub>L</sub> < 50 mA		-1.5 <b>-2.0</b>	+1.5 <b>+2.0</b>	-2.0 <b>-3.5</b>	+2.0 <b>+3.5</b>	
$\frac{\Delta V_O}{\Delta V_{IN}}$	Output Voltage Line Regulation	V <sub>O(NOM)</sub> + 1V ≤ V <sub>IN</sub> ≤ 16V	0.007		0.014 <b>0.032</b>		0.014 <b>0.032</b>	%/V
V <sub>IN</sub> -V <sub>O</sub>	Dropout Voltage (Note 7)	I <sub>L</sub> = 0	1		3 <b>5</b>		3 <b>5</b>	mV
		I <sub>L</sub> = 1 mA	7		10 <b>15</b>		10 <b>15</b>	
		I <sub>L</sub> = 10 mA	40		60 <b>90</b>		60 <b>90</b>	
		I <sub>L</sub> = 50 mA	120		150 <b>225</b>		150 <b>225</b>	
I <sub>GND</sub>	Ground Pin Current	I <sub>L</sub> = 0	65		95 <b>125</b>		95 <b>125</b>	μA
		I <sub>L</sub> = 1 mA	80		110 <b>170</b>		110 <b>170</b>	
		I <sub>L</sub> = 10 mA	140		220 <b>460</b>		220 <b>460</b>	
		I <sub>L</sub> = 50 mA	375		600 <b>1200</b>		600 <b>1200</b>	
		V <sub>ON/OFF</sub> < 0.3V	0.01		0.8		0.8	
		V <sub>ON/OFF</sub> < 0.15V	<b>0.10</b>		<b>2.0</b>		<b>2.0</b>	
V <sub>ON/OFF</sub>	ON/OFF Input Voltage (Note 8)	High = O/P ON	1.4	<b>1.6</b>		<b>1.6</b>		V
		Low = O/P OFF	0.55		<b>0.15</b>		<b>0.15</b>	
I <sub>ON/OFF</sub>	ON/OFF Input Current	V <sub>ON/OFF</sub> = 0	0.01		<b>-2</b>		<b>-2</b>	μA
		V <sub>ON/OFF</sub> = 5V	5		<b>15</b>		<b>15</b>	
I <sub>O(PK)</sub>	Peak Output Current	V <sub>OUT</sub> ≥ V <sub>O(NOM)</sub> - 5%	150	100		100		mA
V <sub>IN</sub> -V <sub>O</sub>	Dropout Voltage	I <sub>L</sub> = 80 mA			225		225	mV
					<b>325</b>		<b>325</b>	
I <sub>GND</sub>	Ground Pin Current	I <sub>L</sub> = 80 mA	525		750 <b>1400</b>		750 <b>1400</b>	μA
e <sub>n</sub>	Output Noise Voltage (RMS)	BW = 300 Hz-50 kHz, C <sub>OUT</sub> = 10 μF C <sub>BYPASS</sub> = 0.01 μF	30					μV

## Electrical Characteristics (Continued)

Limits in standard typeface are for  $T_J = 25^\circ\text{C}$ , and limits in **boldface type** apply over the full operating temperature range. Unless otherwise specified:  $V_{IN} = V_{O(NOM)} + 1\text{V}$ ,  $I_L = 1\text{ mA}$ ,  $C_{IN} = 1\ \mu\text{F}$ ,  $C_{OUT} = 4.7\ \mu\text{F}$ ,  $V_{ON/OFF} = 2\text{V}$ .

Symbol	Parameter	Conditions	Typ	LP2982AI-X.X (Note 6)		LP2982I-X.X (Note 6)		Units
				Min	Max	Min	Max	
$\frac{\Delta V_{OUT}}{\Delta V_{IN}}$	Ripple Rejection	$f = 1\ \text{kHz}$ $C_{OUT} = 10\ \mu\text{F}$	45					dB
$I_{O(MAX)}$	Short Circuit Current	$R_L = 0$ (Steady State) (Note 9)	150					mA

**Note 1:** Absolute maximum ratings indicate limits beyond which damage to the component may occur. Electrical specifications do not apply when operating the device outside of its rated operating conditions.

**Note 2:** The ESD rating of pins 3 and 4 is 1 kV.

**Note 3:** The maximum allowable power dissipation is a function of the maximum junction temperature,  $T_{J(MAX)}$ , the junction-to-ambient thermal resistance,  $\theta_{JA}$ , and the ambient temperature,  $T_A$ . The maximum allowable power dissipation at any ambient temperature is calculated using:

$$P (MAX) = \frac{T_{J(MAX)} - T_A}{\theta_{JA}}$$

The value of  $\theta_{JA}$  for the SOT-23 package is  $220^\circ\text{C/W}$ . Exceeding the maximum allowable power dissipation will cause excessive die temperature, and the regulator will go into thermal shutdown.

**Note 4:** If used in a dual-supply system where the regulator load is returned to a negative supply, the LP2982 output must be diode-clamped to ground.

**Note 5:** The output PNP structure contains a diode between the  $V_{IN}$  and  $V_{OUT}$  terminals that is normally reverse-biased. Reversing the polarity from  $V_{IN}$  to  $V_{OUT}$  will turn on this diode.

**Note 6:** Limits are 100% production tested at  $25^\circ\text{C}$ . Limits over the operating temperature range are guaranteed through correlation using Statistical Quality Control (SQC) methods. The limits are used to calculate National's Averaging Outgoing Level (AOQL).

**Note 7:** Dropout voltage is defined as the input to output differential at which the output voltage drops 100 mV below the value measured with a 1V differential.

**Note 8:** The ON/OFF inputs must be properly driven to prevent possible misoperation. For details, refer to Application Hints.

**Note 9:** See Typical Performance Characteristics curves.

**Typical Performance Characteristics** Unless otherwise specified:  $T_A = 25^\circ\text{C}$ ,  $V_{IN} = V_{O(NOM)} + 1\text{V}$ ,  $C_{OUT} = 4.7\ \mu\text{F}$ ,  $C_{IN} = 1\ \mu\text{F}$ , all voltage options, ON/OFF pin tied to  $V_{IN}$ .

**Output Voltage vs Temperature**

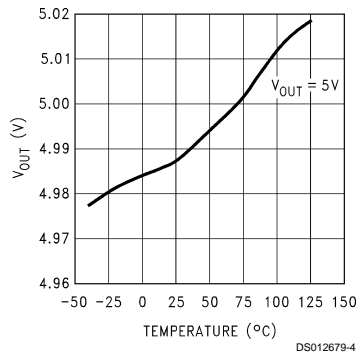

**Output Voltage vs Temperature**

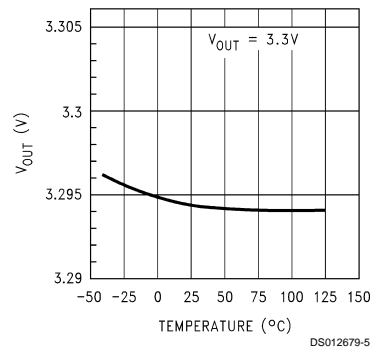

**Typical Performance Characteristics** Unless otherwise specified:  $T_A = 25^\circ\text{C}$ ,  $V_{IN} = V_{O(NOM)} + 1\text{V}$ ,  $C_{OUT} = 4.7\ \mu\text{F}$ ,  $C_{IN} = 1\ \mu\text{F}$ , all voltage options, ON/OFF pin tied to  $V_{IN}$ . (Continued)

**Output Voltage vs Temperature**

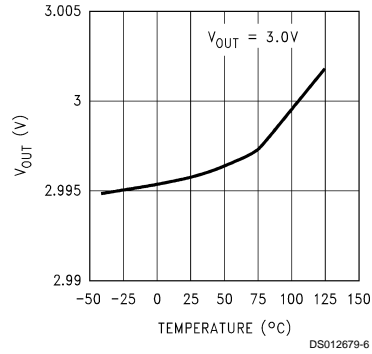

**Dropout Characteristics**

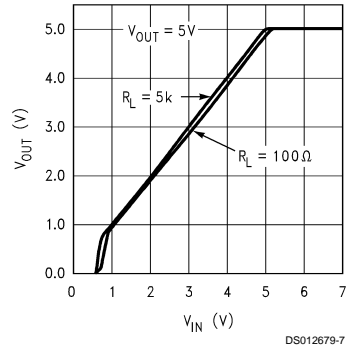

**Dropout Characteristics**

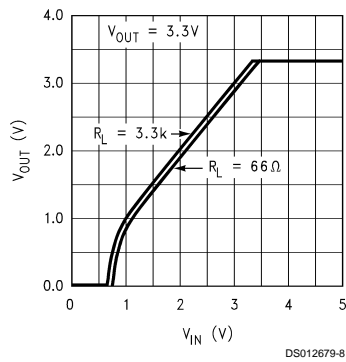

**Dropout Characteristics**

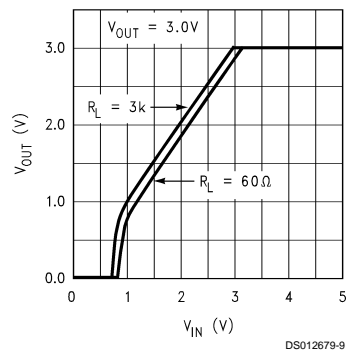

**Dropout Voltage vs Temperature**

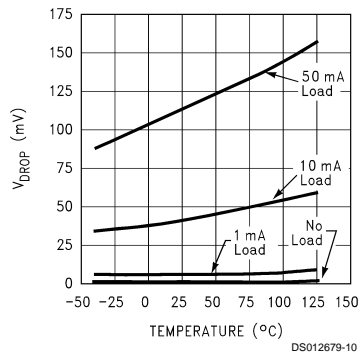

**Dropout Voltage vs Load Current**

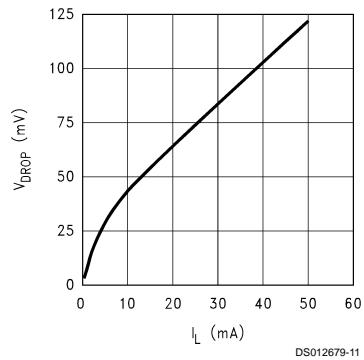

**Typical Performance Characteristics** Unless otherwise specified:  $T_A = 25^\circ\text{C}$ ,  $V_{IN} = V_{O(NOM)} + 1\text{V}$ ,  $C_{OUT} = 4.7\ \mu\text{F}$ ,  $C_{IN} = 1\ \mu\text{F}$ , all voltage options, ON/OFF pin tied to  $V_{IN}$ . (Continued)

**Ground Pin Current vs Temperature**

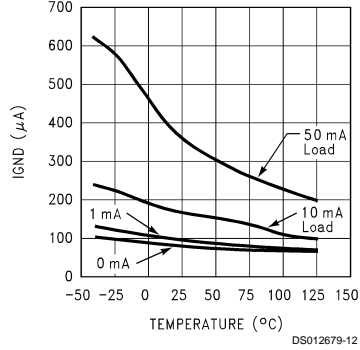

**Ground Pin Current vs Load Current**

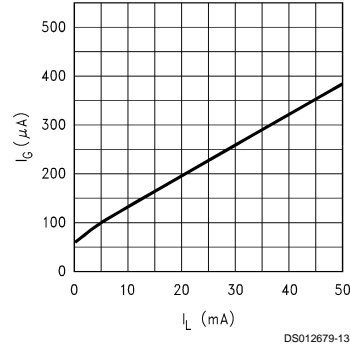

**Input Current vs  $V_{IN}$**

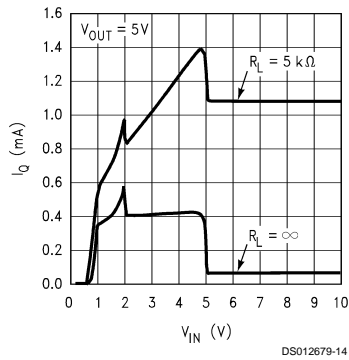

**Input Current vs  $V_{IN}$**

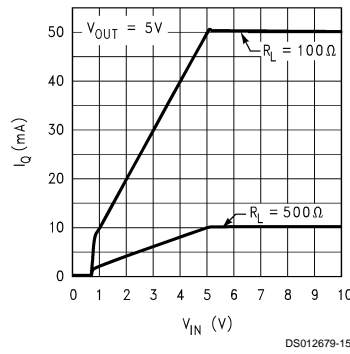

**Line Transient Response**

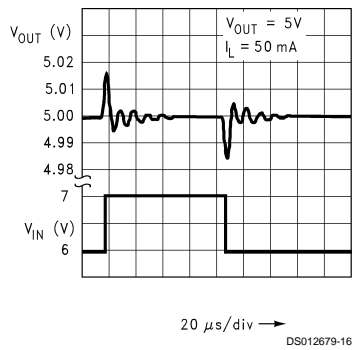

**Line Transient Response**

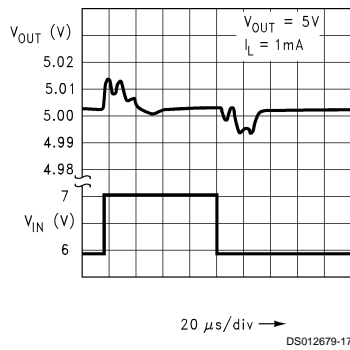

**Typical Performance Characteristics** Unless otherwise specified:  $T_A = 25^\circ\text{C}$ ,  $V_{IN} = V_{O(NOM)} + 1\text{V}$ ,  $C_{OUT} = 4.7\ \mu\text{F}$ ,  $C_{IN} = 1\ \mu\text{F}$ , all voltage options, ON/OFF pin tied to  $V_{IN}$ . (Continued)

**Load Transient Response**

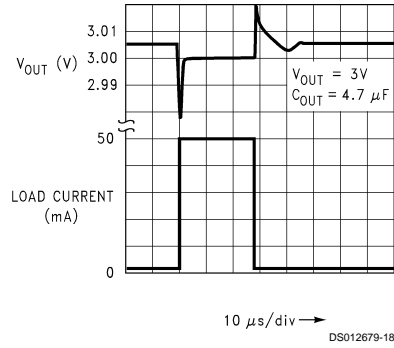

**Load Transient Response**

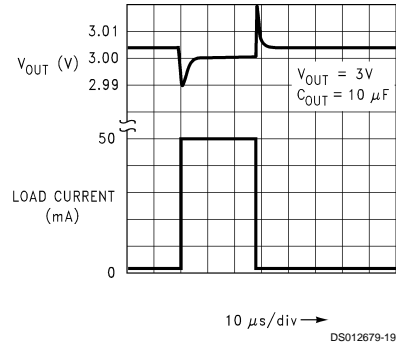

**Load Transient Response**

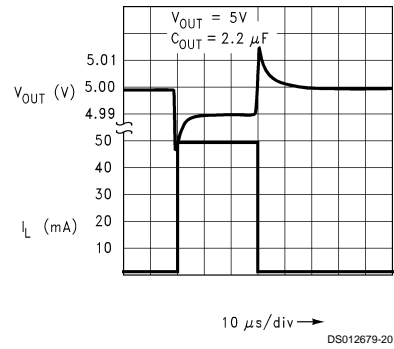

**Load Transient Response**

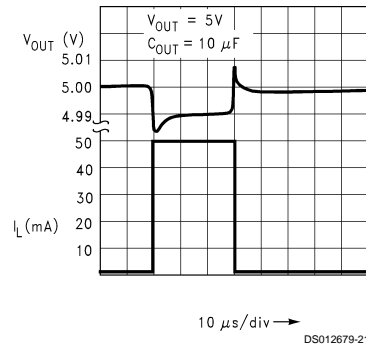

**Short Circuit Current**

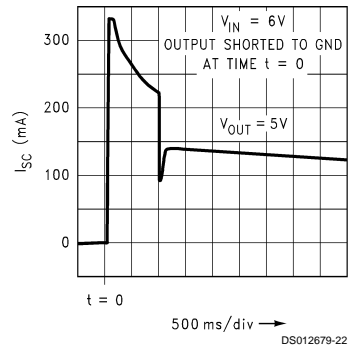

**Instantaneous Short Circuit Current vs Temperature**

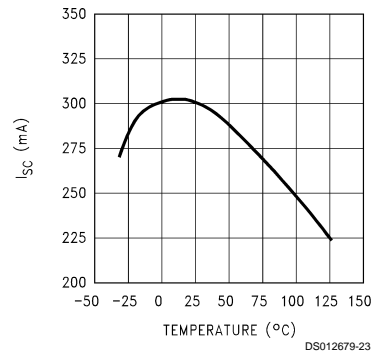



**Typical Performance Characteristics** Unless otherwise specified:  $T_A = 25^\circ\text{C}$ ,  $V_{IN} = V_{O(NOM)} + 1\text{V}$ ,  $C_{OUT} = 4.7\ \mu\text{F}$ ,  $C_{IN} = 1\ \mu\text{F}$ , all voltage options, ON/OFF pin tied to  $V_{IN}$ . (Continued)

**Short Circuit Current**

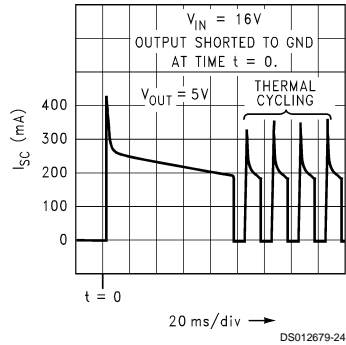

**Instantaneous Short Circuit Current vs Output Voltage**

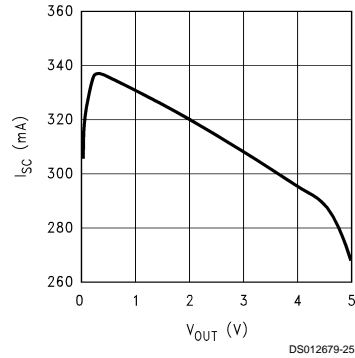

**Output Impedance vs Frequency**

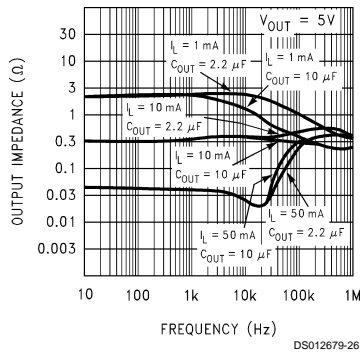

**Output Impedance vs Frequency**

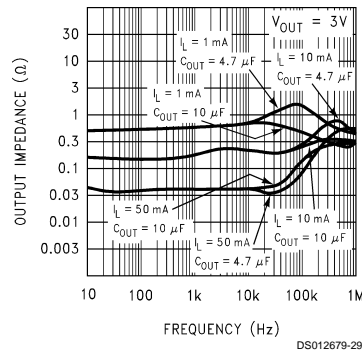

**ON/OFF Pin Current vs  $V_{ON/OFF}$**

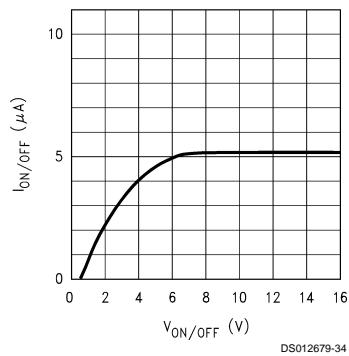

**ON/OFF Threshold vs Temperature**

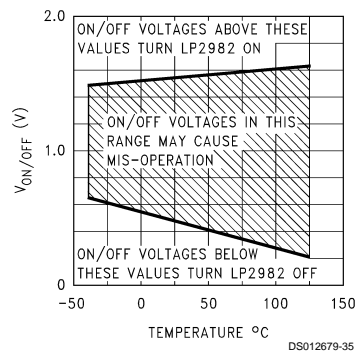

**Typical Performance Characteristics** Unless otherwise specified:  $T_A = 25^\circ\text{C}$ ,  $V_{IN} = V_{O(NOM)} + 1\text{V}$ ,  $C_{OUT} = 4.7\ \mu\text{F}$ ,  $C_{IN} = 1\ \mu\text{F}$ , all voltage options, ON/OFF pin tied to  $V_{IN}$ . (Continued)

**Input to Output Leakage vs Temperature**

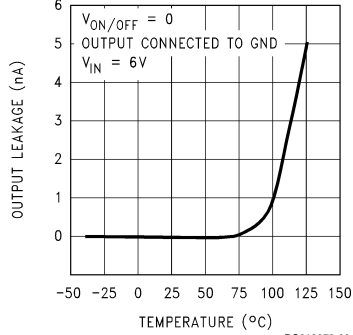

**Output Reverse Leakage vs Temperature**

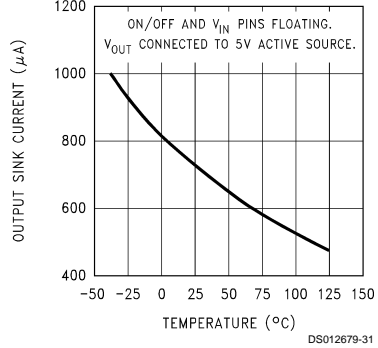

**Output Noise Density**

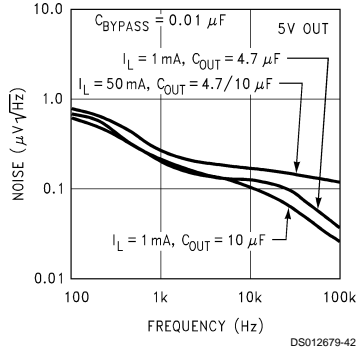

**Output Noise Density**

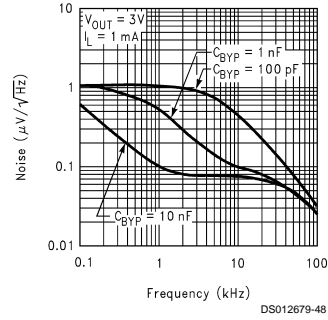

**Output Noise Density**

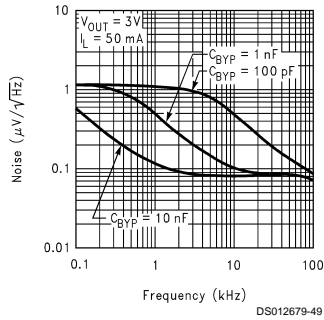

**Ripple Rejection**

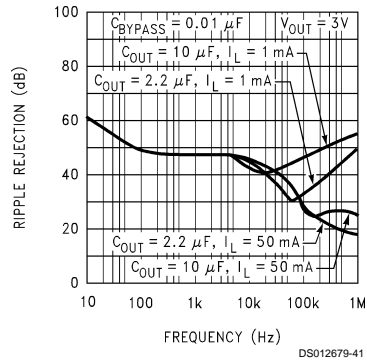

**Typical Performance Characteristics** Unless otherwise specified:  $T_A = 25^\circ\text{C}$ ,  $V_{IN} = V_{O(NOM)} + 1\text{V}$ ,  $C_{OUT} = 4.7\ \mu\text{F}$ ,  $C_{IN} = 1\ \mu\text{F}$ , all voltage options, ON/OFF pin tied to  $V_{IN}$ . (Continued)

**Turn-ON Waveform**

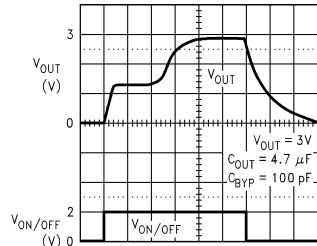

100  $\mu\text{s}/\text{Div}$

DS012679-50

**Turn-ON Waveform**

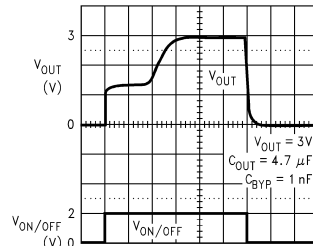

1 ms/Div

DS012679-51

**Turn-ON Waveform**

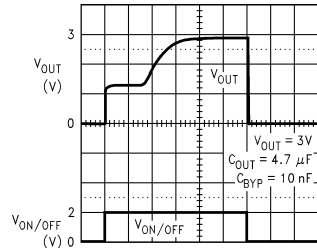

10 ms/Div

DS012679-52

## Application Hints

### EXTERNAL CAPACITORS

Like any low-dropout regulator, the external capacitors used with the LP2982 must be carefully selected to assure regulator loop stability.

**INPUT CAPACITOR:** An input capacitor whose value is  $\geq 1 \mu\text{F}$  is required with the LP2982 (amount of capacitance can be increased without limit).

This capacitor must be located a distance of not more than 0.5" from the input pin of the LP2982 and returned to a clean analog ground. Any good quality ceramic or tantalum can be used for this capacitor.

**OUTPUT CAPACITOR:** The output capacitor must meet both the requirement for minimum amount of capacitance and E.S.R. (equivalent series resistance) value. Curves are provided which show the allowable ESR range as a function of load current for various output voltages and capacitor values (refer to Figure 1, Figure 2).

**IMPORTANT:** The output capacitor must maintain its ESR in the stable region over the full operating temperature to assure stability. Also, capacitor tolerance and variation with temperature must be considered to assure the minimum amount of capacitance is provided at all times.

This capacitor should be located not more than 0.5" from the output pin of the LP2982 and returned to a clean analog ground.

**LOW-CURRENT OPERATION:** In applications where the load current is  $< 1 \text{ mA}$ , special consideration must be given to the output capacitor.

Circuitry inside the LP2982 is specially designed to reduce operating (quiescent) current at light loads down to about  $65 \mu\text{A}$ .

The mode of operation which yields this very low quiescent current also means that the output capacitor ESR is critical.

For optimum stability and minimum output noise, it is recommended that a  $10\Omega$  resistor be placed in series with the output capacitor in any applications where  $I_L < 1 \text{ mA}$ .

### CAPACITOR CHARACTERISTICS

**TANTALUM:** Tantalum capacitors are the best choice for use with the LP2982. Most good quality tantalums can be used with the LP2982, but check the manufacturer's data sheet to be sure the ESR is in range.

It is important to remember that ESR increases sharply at lower temperatures ( $< 10^\circ\text{C}$ ) and a capacitor that is near the upper limit for stability at room temperature can cause instability when it gets cold.

In applications which must operate at very low temperatures, it may be necessary to parallel the output tantalum capacitor with a ceramic capacitor to prevent the ESR from going up too high (see next section for important information on ceramic capacitors).

**CERAMIC:** Ceramic capacitors are not recommended for use at the output of the LP2982. This is because the ESR of a ceramic can be low enough to go below the minimum stable value for the LP2982. A good  $2.2 \mu\text{F}$  ceramic was measured and found to have an ESR of about  $15 \text{ m}\Omega$ , which is low enough to cause oscillations.

If a ceramic capacitor is used on the output, a  $1\Omega$  resistor should be placed in series with the capacitor.

**ALUMINUM:** Because of large physical size, aluminum electrolytics are not typically used with the LP2982. They must

meet the same ESR requirements over the operating temperature range, which is more difficult because of their large increase in ESR at cold temperature.

An aluminum electrolytic can exhibit an ESR increase of as much as 50X when going from  $20^\circ\text{C}$  to  $-40^\circ\text{C}$ . Also, some aluminum electrolytics are not operational below  $-25^\circ\text{C}$  because the electrolyte can freeze.

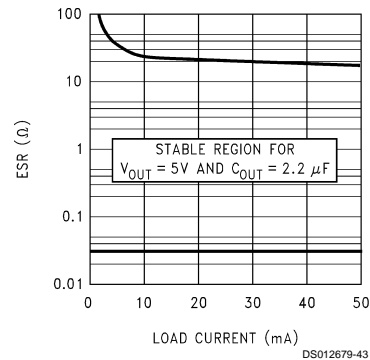

FIGURE 1. 5V/2.2  $\mu\text{F}$  ESR Curves

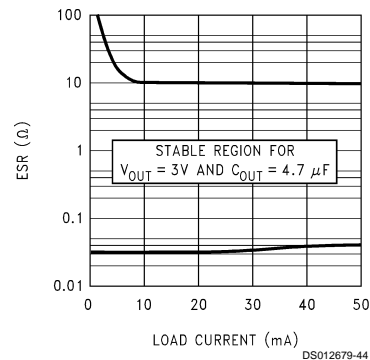

FIGURE 2. 3V/4.7  $\mu\text{F}$  ESR Curves

### BYPASS CAPACITOR

The  $0.01 \mu\text{F}$  capacitor connected to the bypass pin to reduce noise must have very low leakage.

The current flowing out of the bypass pin comes from the bandgap reference, which is used to set the output voltage.

This capacitor leakage current causes the output voltage to decline by an amount proportional to the current. Typical values are  $-0.015\%/n\text{A}$  @  $-40^\circ\text{C}$ ,  $-0.021\%/n\text{A}$  @  $25^\circ\text{C}$ , and  $-0.035\%/n\text{A}$  @  $+125^\circ\text{C}$ .

This data is valid up to a maximum leakage current of about  $500 \text{ nA}$ , beyond which the bandgap is so severely loaded that it can not function.

Care must be taken to ensure that the capacitor selected will not have excessive leakage current over the operating temperature range of the application.

A high quality ceramic capacitor which uses either NPO or COG type dielectric material will typically have very low leakage. Small surface mount polypropylene or polycarbonate film capacitors also have extremely low leakage, but are slightly larger than ceramics.

## Application Hints (Continued)

### REVERSE CURRENT PATH

The power transistor used in the LP2982 has an inherent diode connected between the regulator input and output (see below).

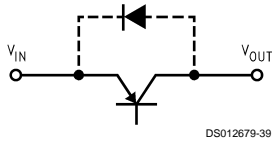

If the output is forced above the input by more than a  $V_{BE}$ , this diode will become forward biased and current will flow from the  $V_{OUT}$  terminal to  $V_{IN}$ . This current must be limited to  $< 100$  mA to prevent damage to the part.

The internal diode can also be turned on by abruptly stepping the input voltage to a value below the output voltage.

To prevent regulator mis-operation, a Schottky diode should be used in any application where input/output voltage conditions can cause the internal diode to be turned on (see below).

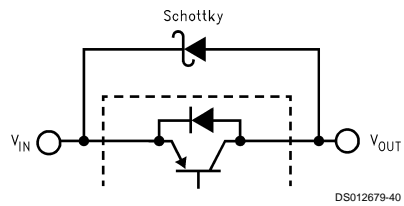

As shown, the Schottky diode is connected in parallel with the internal parasitic diode and prevents it from being turned on by limiting the voltage drop across it to about 0.3V.

### ON/OFF INPUT OPERATION

The LP2982 is shut off by pulling the ON/OFF input low, and turned on by driving the input high. If this feature is not to be used, the ON/OFF input should be tied to  $V_{IN}$  to keep the regulator on at all times (the ON/OFF input must **not** be left floating).

To ensure proper operation, the signal source used to drive the ON/OFF input must be able to swing above and below the specified turn-on/turn-off voltage thresholds which guarantee an ON or OFF state (see Electrical Characteristics).

The ON/OFF signal may come from either a totem-pole output, or an open-collector output with pull-up resistor to the LP2982 input voltage or another logic supply. The high-level voltage may exceed the LP2982 input voltage, but must remain within the Absolute Maximum Ratings for the ON/OFF pin.

It is also important that the turn-on/turn-off voltage signals applied to the ON/OFF input have a slew rate which is greater than  $40$  mV/ $\mu$ s.

Important: the regulator shutdown function will operate incorrectly if a slow-moving signal is applied to the ON/OFF input.

**Physical Dimensions** inches (millimeters) unless otherwise noted

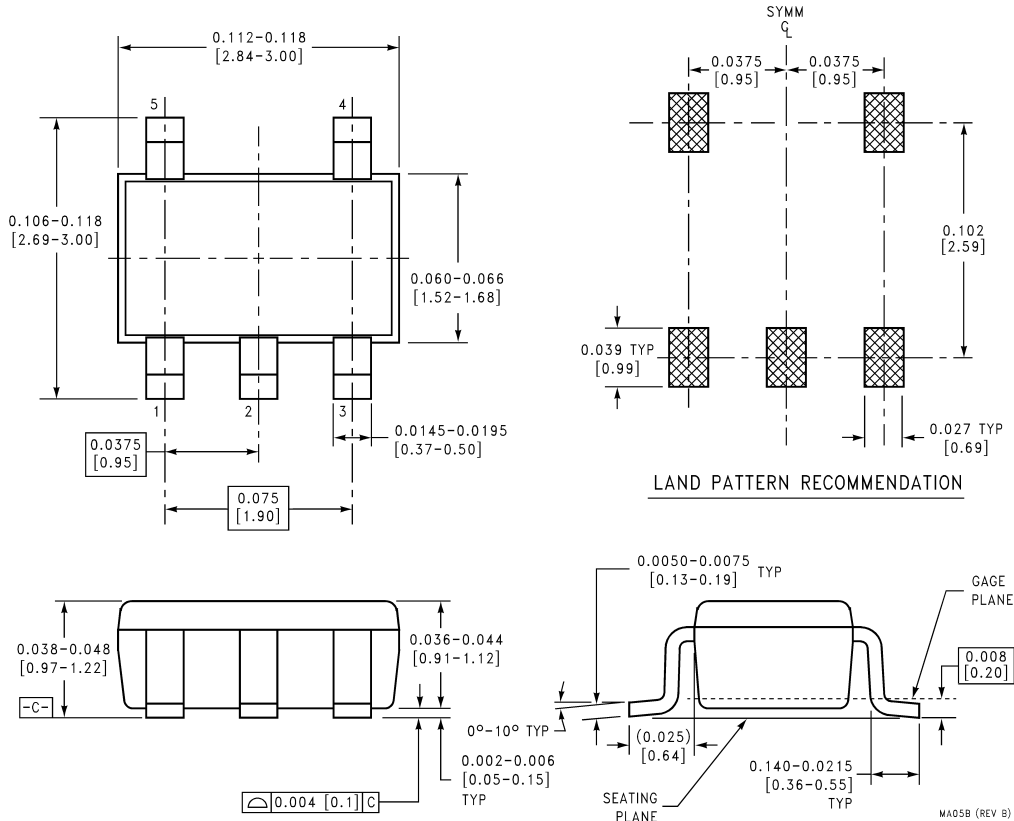

**5-Lead Small Outline Package (M5)  
NS Package Number MA05B**

For Order Numbers, refer to Table I in the "Ordering Information" section of this document.

**LIFE SUPPORT POLICY**

NATIONAL'S PRODUCTS ARE NOT AUTHORIZED FOR USE AS CRITICAL COMPONENTS IN LIFE SUPPORT DEVICES OR SYSTEMS WITHOUT THE EXPRESS WRITTEN APPROVAL OF THE PRESIDENT AND GENERAL COUNSEL OF NATIONAL SEMICONDUCTOR CORPORATION. As used herein:

1. Life support devices or systems are devices or systems which, (a) are intended for surgical implant into the body, or (b) support or sustain life, and whose failure to perform when properly used in accordance with instructions for use provided in the labeling, can be reasonably expected to result in a significant injury to the user.
2. A critical component is any component of a life support device or system whose failure to perform can be reasonably expected to cause the failure of the life support device or system, or to affect its safety or effectiveness.



**National Semiconductor Corporation**  
Americas  
Tel: 1-800-272-9959  
Fax: 1-800-737-7018  
Email: support@nsc.com

**National Semiconductor Europe**  
Fax: +49 (0) 1 80-530 85 86  
Email: europe.support@nsc.com  
Deutsch Tel: +49 (0) 1 80-530 85 85  
English Tel: +49 (0) 1 80-532 78 32  
Français Tel: +49 (0) 1 80-532 93 58  
Italiano Tel: +49 (0) 1 80-534 16 80

**National Semiconductor Asia Pacific Customer Response Group**  
Tel: 65-2544466  
Fax: 65-2504466  
Email: sea.support@nsc.com

**National Semiconductor Japan Ltd.**  
Tel: 81-3-5639-7560  
Fax: 81-3-5639-7507

www.national.com