

## Single-phase DC Brushless Motor Driver IC

### ■ GENERAL DESCRIPTION

The NJU7332 is a single-phase DC brushless motor driver IC for very small fan-motor application. It features MOS-FET driver circuit for better saturation characteristics. Slew rate of amplifiers and feedback resistors are optimized to achieve low-noise motor operation.

NJU7332 adopt a very small FFP package, therefore it is suitable for micro motor applications.

### ■ PACKAGE OUTLINE

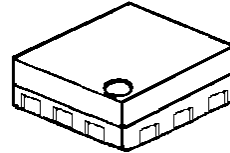

NJU7332PB1

### ■ FEATURES

- Single Supply
- Operating Voltage  $V_{DD}=2.4 \sim 5.5V$
- Low Operating Current
- Low Saturation Output Voltage  
 $V_{sat}=\pm 0.2V @ I_o=\pm 100mA$
- C-MOS Technology
- Package Outline FFP12 (2×2×0.85mm)

### ■ PIN CONFIGURATIONS

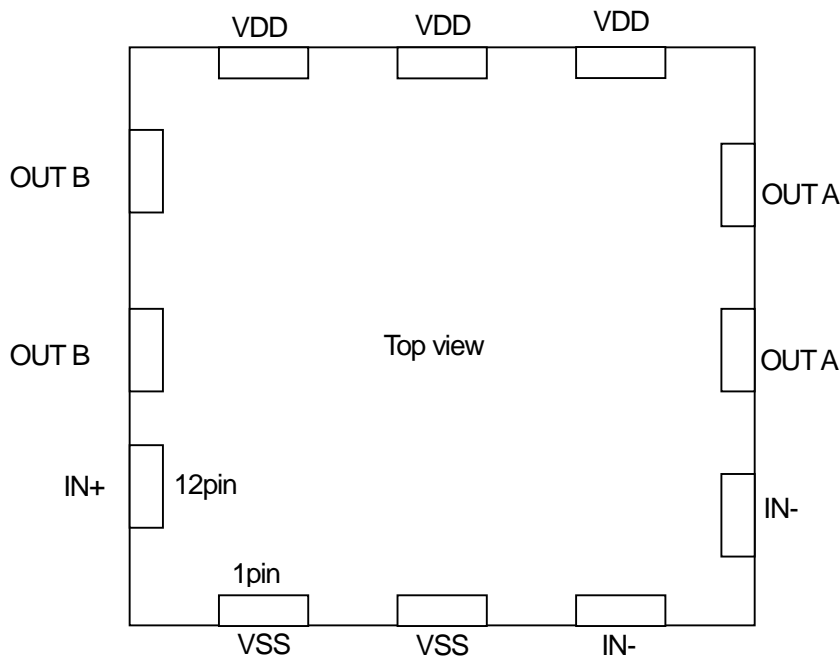

# NJU7332

Preliminary

## ■ ABSOLUTE MAXIMUM RATINGS

(Ta=25°C)

PARAMETER	RATINGS	SYMBOL(unit)	NOTE
Supply Voltage	+7.0	V <sub>DD</sub> (V)	
Input Voltage	-0.3 ~ V <sub>DD</sub> +0.3	V <sub>ID</sub> (V)	
Operating Temperature Range	-40 ~ +85	T <sub>opr</sub> (°C)	
Storage Temperature Range	-50 ~ +150	T <sub>stg</sub> (°C)	
Power Dissipation	300	P <sub>D</sub> (mW)	1)

1) When mounted on a glass epoxy board.

## ■ RECOMMENDED OPERATING CONDITIONS

V<sub>DD</sub>=2.4V~5.5V

## ■ ELECTRICAL CHARACTERISTICS

(V<sup>+</sup>=5V, Ta=25°C)

PARAMETER	SYMBOL	CONDITION	MIN.	TYP.	MAX.	UNIT
Operating Current	I <sub>DD</sub>	-	-	3.0	4.0	mA
Input Offset Voltage	V <sub>IO</sub>	-	-10	-	-10	mV
Input Common Mode Voltage Range	V <sub>ICM</sub>	-	0.4-4.0	-	-	V
Maximum Output Voltage Range	V <sub>OM</sub>	I <sub>o</sub> =+100mA	4.70	4.80	-	V
Feedback Resistance	R <sub>F</sub>	I <sub>o</sub> = -100mA	-	0.20	0.30	kΩ
		-	22.0	27.5	33.0	
Open Loop Gain	A <sub>V</sub>	-	-	80	-	dB

## ■ TYPICAL CHARACTERISTICS

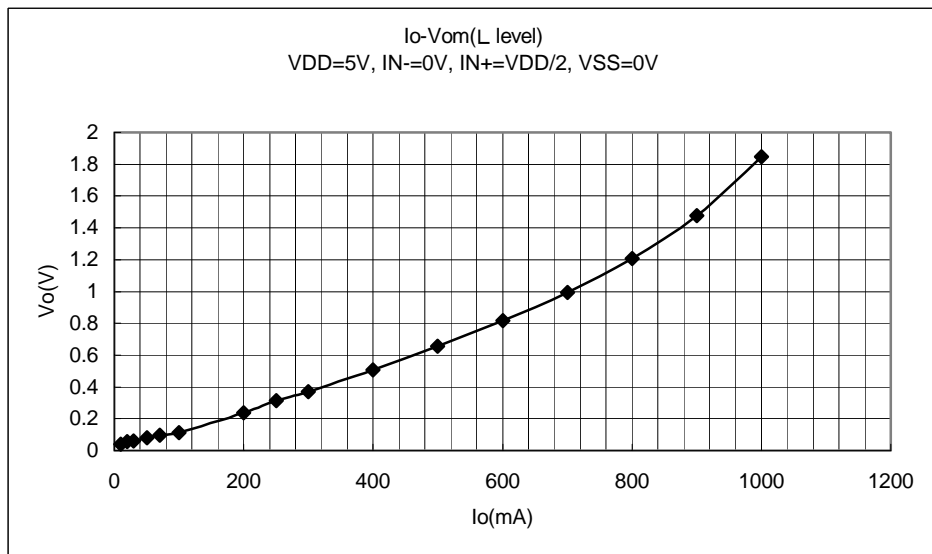
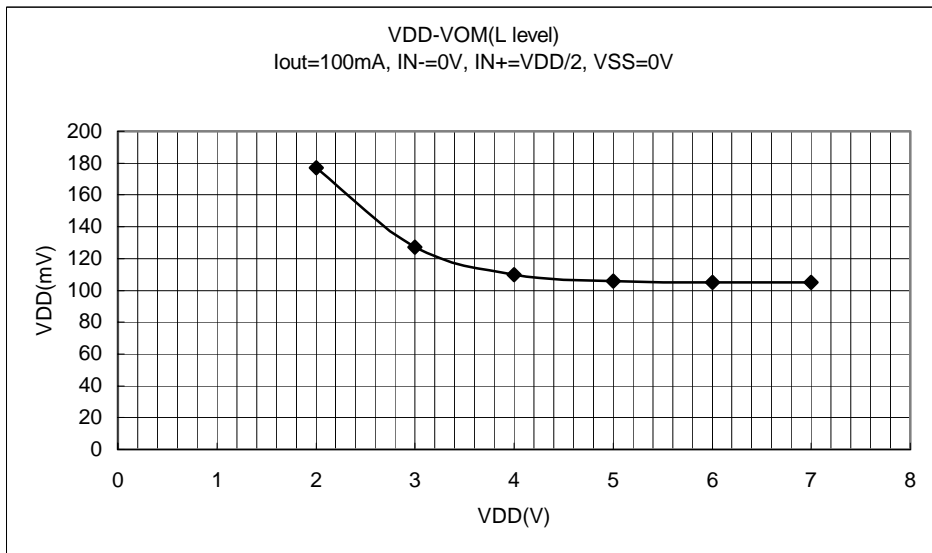
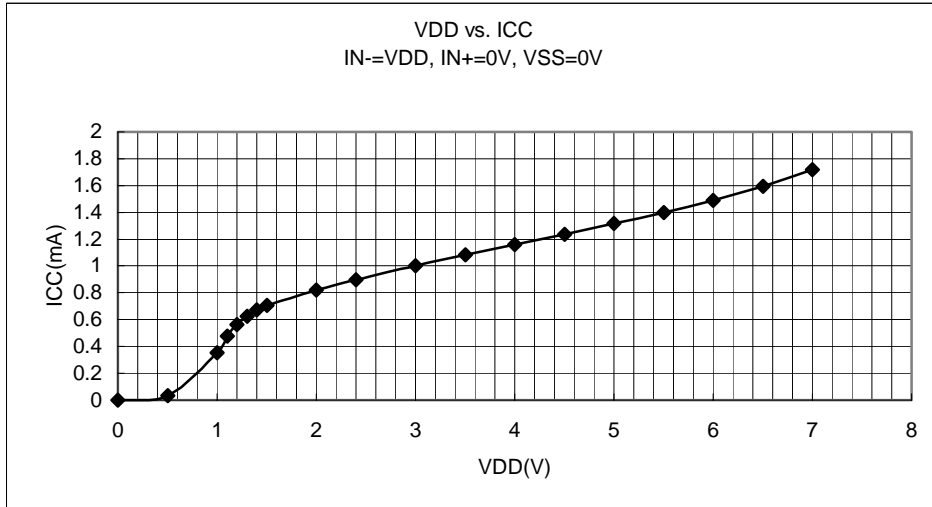

Preliminary

## ■ TYPICAL CHARACTERISTICS

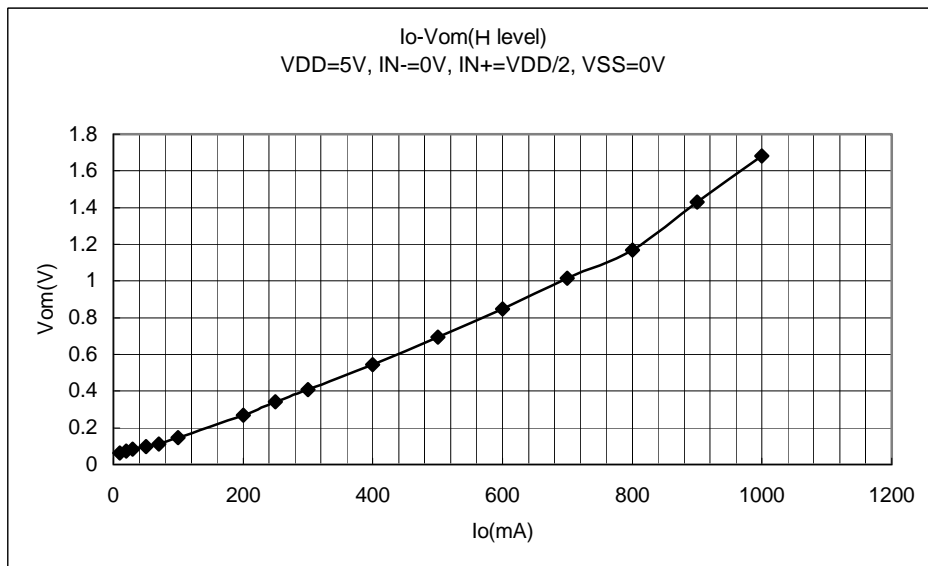
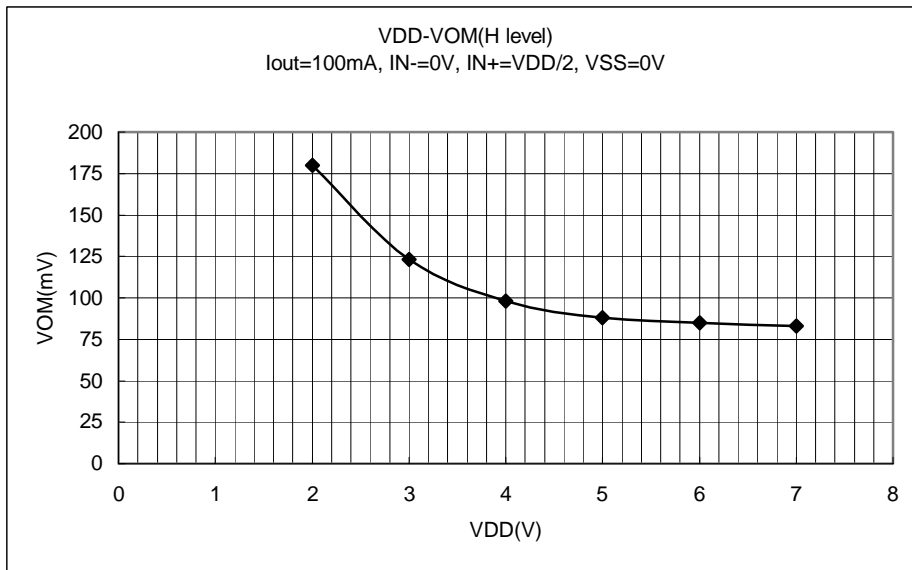

## APPLICATION NOTE

The NJU7332 is a single-phase DC brushless motor driver IC featuring CMOS process. It is suitable for fan motor drivers for a small equipment such as the note personal computers.

[Application Circuit Example]

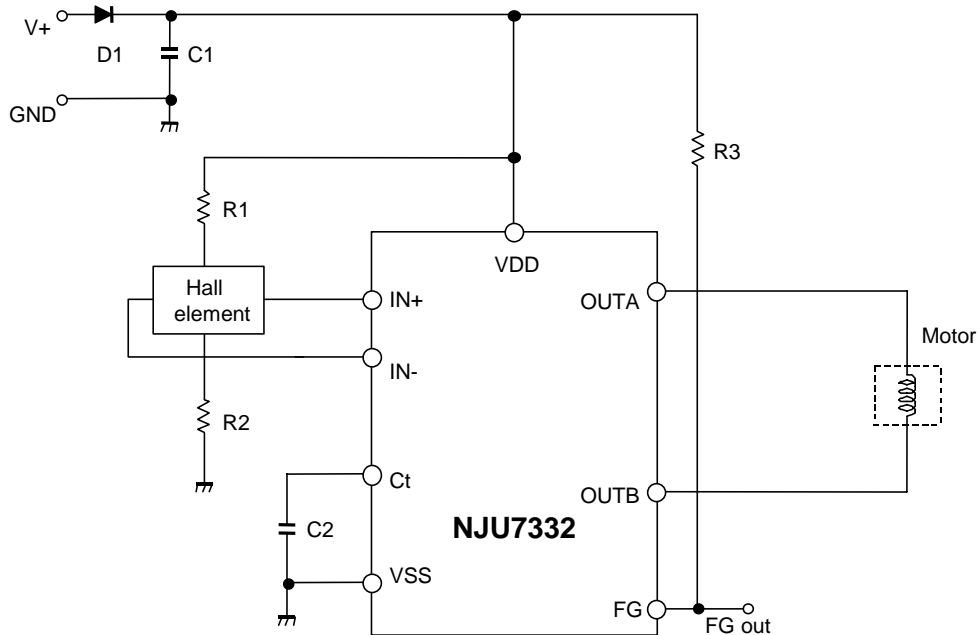

[Design Notes]

Above application example is designed for 5V operation with motor current of 100mA. It uses the following components:

Hall Elements: HW101A (AKE)

### 1. Selection of C1 and D1:

C1 is used for a noise reduction purpose. A typical value is 0.1uF.

Optimize the value in actual operating conditions if necessary. D1 is a diode for protection against reverse voltage supply. Silicon rectifier diode (WO3C, 10D1 and equivalent) is appropriate.

### 2. Design of hall element bias resistance (R1 and R2)

Hall amplifier is a differential amplifier with hysteresis characteristics (24mV typical).

The common-mode input voltage is between 0.4V and VDD-1V and the input signal must be within the range. Non-excitation hall bias voltage is to be set at a half of VDD for effective use of common-mode input voltage range. Therefore the same value of hall bias resistors is selected for R1 and R2.

Given that the bias current is set to be 5mA by HW101A datasheet, R1 and R2 can be determined as

$$R1 + R2 + Rin = \frac{VDD}{I_{hbias}} = \frac{5}{5 \times 10^{-3}} = 1k\Omega$$

$$R1 = R2 = 300\Omega$$

follows:

The output voltage of hall elements is influenced by the bias current and magnetic flux density of hall elements.

The optimum input voltage of NJU7332 is 100mVp-p and higher. With such input voltage, the highest efficiency can be obtained.

The specifications on this data book are only given for information, without any guarantee as regards either mistakes or omissions. The application circuit in this data book are described only to show representative usages of the product and not intended for the guarantee or permission of any right including the industrial rights.