

## *Rail-to-Rail Output*

## *Low Voltage, Low Supply current*

## *General Purpose Dual OP Amps*

### FEATURES

- CMOS rail to rail output
- 2.7 to 5.5V single supply operation
- Low supply current : 112uA (per channel)
- Gain-Bandwidth Product : 1MHz
- Slew rate : 1V/μs
- No crossover distortion
- Space saving package SOP8, MSOP8
- Cost efficient
- Pin assignments is the same as the general-purpose dual operational amplifiers

### APPLICATIONS

- Active filters
- Supply current monitoring
- Battery monitoring
- Voice preamplifier
- General purpose low voltage applications
- General purpose portable devices
- Cross-reference :  
LMV358

### DESCRIPTION

The MSV358 is the most cost-effective solutions for applications where low voltage operation. Each amplifier has low supply current of 112uA. The IC designed to be used for general purpose amplifier of general electronic equipment for consumer appliances.

### BLOCK DIAGRAM

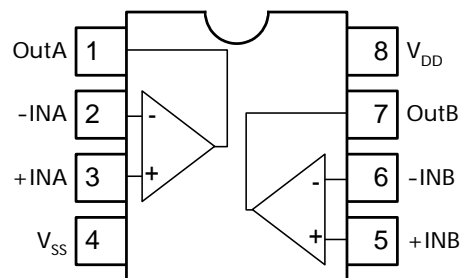

### PINNING

Symbol	Pin	Description
OutA	1	output A
-INA	2	inverting input A
+INA	3	non-inverting input A
V <sub>SS</sub>	4	negative supply
+INB	5	non-inverting input B
-INB	6	inverting input B
OutB	7	output B
V <sub>DD</sub>	8	positive supply

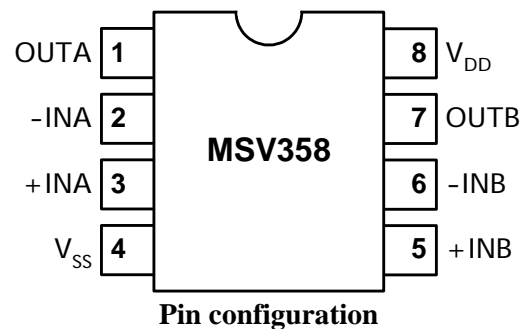

## ELECTRICAL CHARACTERISTICS

Symbol	Parameter	Min	Typ	Max	Unit
V <sub>DD</sub>	Single power supply voltage	2.7	-	5.5	V
T <sub>opr</sub>	Operating temperature	-20	-	85	°C
T <sub>stg</sub>	Storage temperature	-40	-	125	°C
V <sub>ESD</sub>	Electrostatic handling	-2000	-	2000	V

## 5V DC ELECTRICAL CHARACTERISTICS

(T<sub>a</sub>=25°C, V<sub>DD</sub>=5V, V<sub>SS</sub>=0V, V<sub>CM</sub>=V<sub>O</sub>= V<sub>DD</sub>/2)

Symbol	Parameter	Conditions	Min	Typ	Max	Unit
V <sub>OS</sub>	Input offset voltage		-	1	5	mV
CMRR	Common mode rejection ratio	0 ≤ V <sub>CM</sub> ≤ 4V	50	65	-	dB
+PSRR	Positive Power supply rejection ratio	Ripple = 400mV , 100Hz	-	61	-	dB
-PSRR	Negative Power supply rejection ratio	Ripple = 400mV , 100Hz	-	59	-	dB
V <sub>CM</sub>	Common mode voltage	CMRR ≥ 50dB	-0.2	-	4.2	V
V <sub>O</sub>	Output voltage swing	R <sub>L</sub> =100kΩ, A <sub>v</sub> = -1 (THD+N) < -65dB	-	V <sub>DD</sub> -10	V <sub>DD</sub> -5	mV
I <sub>S</sub>	Supply current	Dual Amplifiers	-	224	-	μA

## 5V AC ELECTRICAL CHARACTERISTICS

(T<sub>a</sub>=25°C, V<sub>DD</sub>=5V, V<sub>SS</sub>=0V, V<sub>CM</sub>=V<sub>O</sub>= V<sub>DD</sub>/2)

Symbol	Parameter	Conditions	Min	Typ	Max	Unit
SR	Slew rate		-	1	-	V/μs
GBWP	Gain bandwidth product		-	1	-	MHz
(THD+N) /S	Total harmonic distortion plus noise	f = 1kHz, A <sub>v</sub> = -1 R <sub>L</sub> > 10k, V <sub>in</sub> = 4V <sub>pp</sub>	-	-75	-70	dB

## 2.7V DC ELECTRICAL CHARACTERISTICS

(T<sub>a</sub>=25°C, V<sub>DD</sub>=2.7V, V<sub>SS</sub>=0V, V<sub>CM</sub>=V<sub>O</sub>= V<sub>DD</sub>/2)

Symbol	Parameter	Test conditions	Min	Typ	Max	Unit
V <sub>OS</sub>	Input offset voltage		-	1	5	mV
CMRR	Common mode rejection ratio	0 ≤ V <sub>CM</sub> ≤ 1.7V	50	63	-	dB
+PSRR	Positive Power supply rejection ratio	Ripple = 200mV , 100Hz	-	-56	-	dB
-PSRR	Negative Power supply rejection ratio	Ripple = 200mV , 100Hz	-	-63	-	dB
V <sub>CM</sub>	Common mode voltage	CMRR ≥ 50dB	-0.2	-	1.9	V
V <sub>O</sub>	Output voltage swing	R <sub>L</sub> =100kΩ, A <sub>v</sub> = -1 (THD+N) < -65dB	-	V <sub>DD</sub> -25	V <sub>DD</sub> -10	mV
I <sub>S</sub>	Supply current	Dual Amplifiers	-	192	-	μA

## 2.7V AC ELECTRICAL CHARACTERISTICS

( $T_a=25^\circ\text{C}$ ,  $V_{DD}=2.7\text{V}$ ,  $V_{SS}=0\text{V}$ ,  $V_{CM}=V_O=V_{DD}/2$ )

Symbol	Parameter	Conditions	Min	Typ	Max	Unit
GBWP	Gain bandwidth product		-	1	-	MHz
(THD+N) /S	Total harmonic distortion plus noise	$f = 1\text{kHz}$ , $A_v = -1$ $R_L > 10\text{k}$ , $V_{in} = 2\text{V}_{pp}$	-	-70	-65	dB

## APPLICATION INFORMATION (Single Supply)

### Voltage Follower

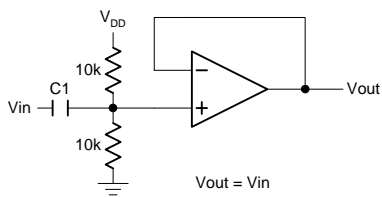

### Difference Amplifier

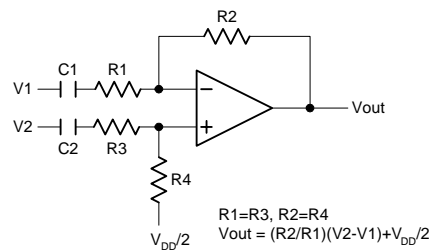

### Inverting Amplifier

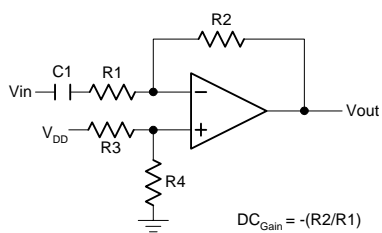

### Simple High-Pass Filter

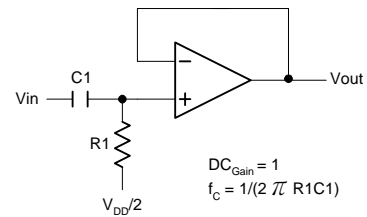

### Simple Low-Pass Filter

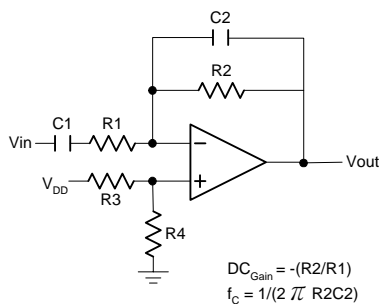

### 2nd Order Multiple Feedback Low-Pass Filter

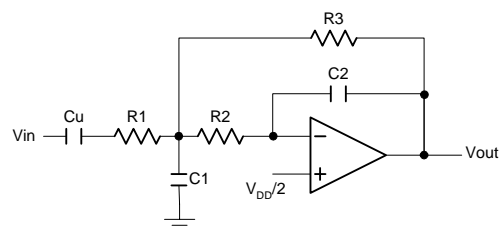

## EXTERNAL DIMENSIONS

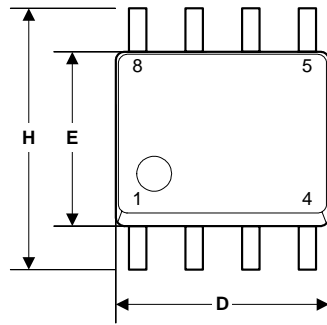

Symbol	Dimension in mm		Dimension in inch	
	Min	Max	Min	Max
A	1.35	1.75	0.0532	0.0688
A1	0.10	0.25	0.0040	0.0098
B	0.33	0.51	0.013	0.020
C	0.19	0.25	0.0075	0.0098
D	4.80	5.00	0.1890	0.1968
H	5.80	6.20	0.2284	0.2440
E	3.80	4.00	0.1497	0.1574
e	1.27 BSC		0.050 BSC	
L	0.40	1.27	0.016	0.050

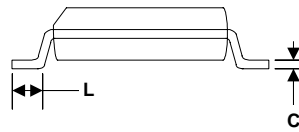
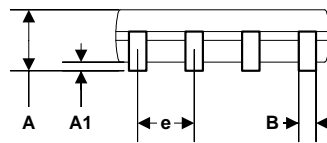

**SOP8**

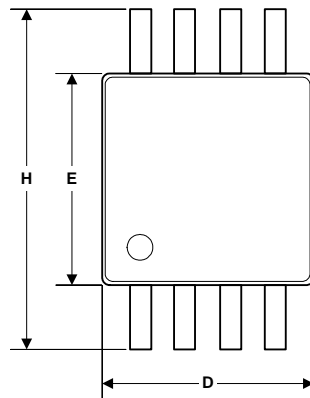

Symbol	Dimension in mm		Dimension in inch	
	Min	Max	Min	Max
A	0.81	1.12	0.032	0.048
A1	0.05	0.15	0.002	0.006
A2	0.76	0.86	0.030	0.038
B	0.28	0.38	0.011	0.015
C	0.13	0.23	0.005	0.009
D	2.90	3.10	0.114	0.122
H	4.70	5.10	0.185	0.201
E	2.90	3.10	0.114	0.122
e	0.65		0.026	
L	0.40	0.66	0.016	0.026

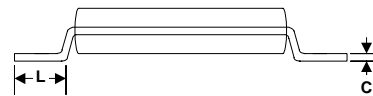
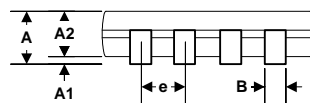

**MSOP8**

### TAPE AND REEL (Unit : mm)

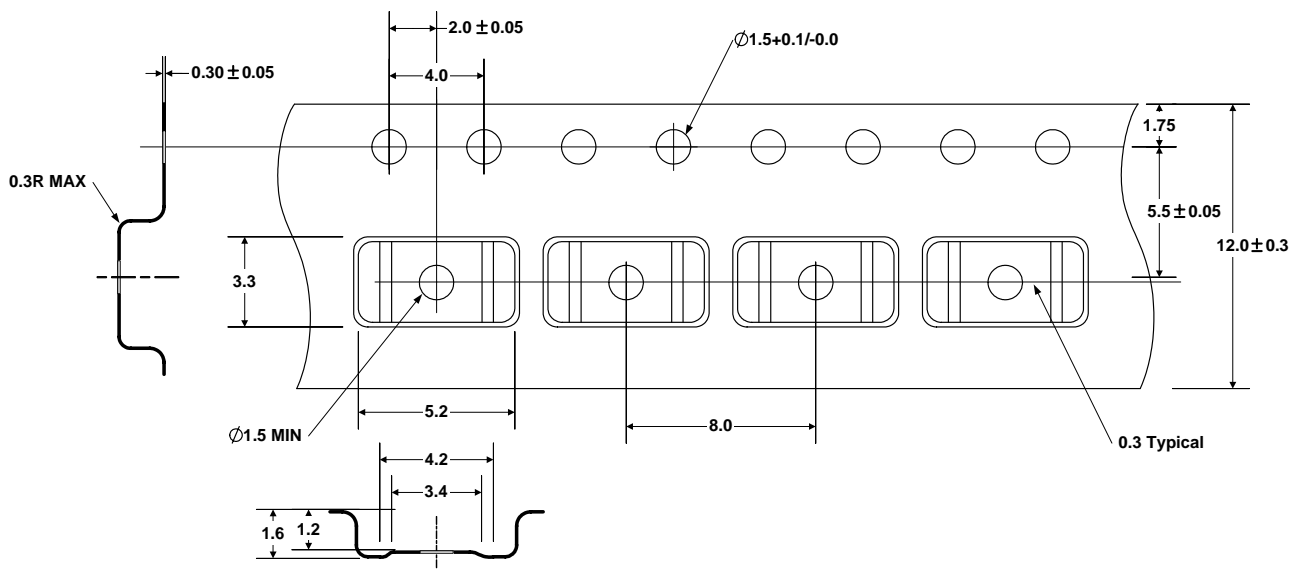
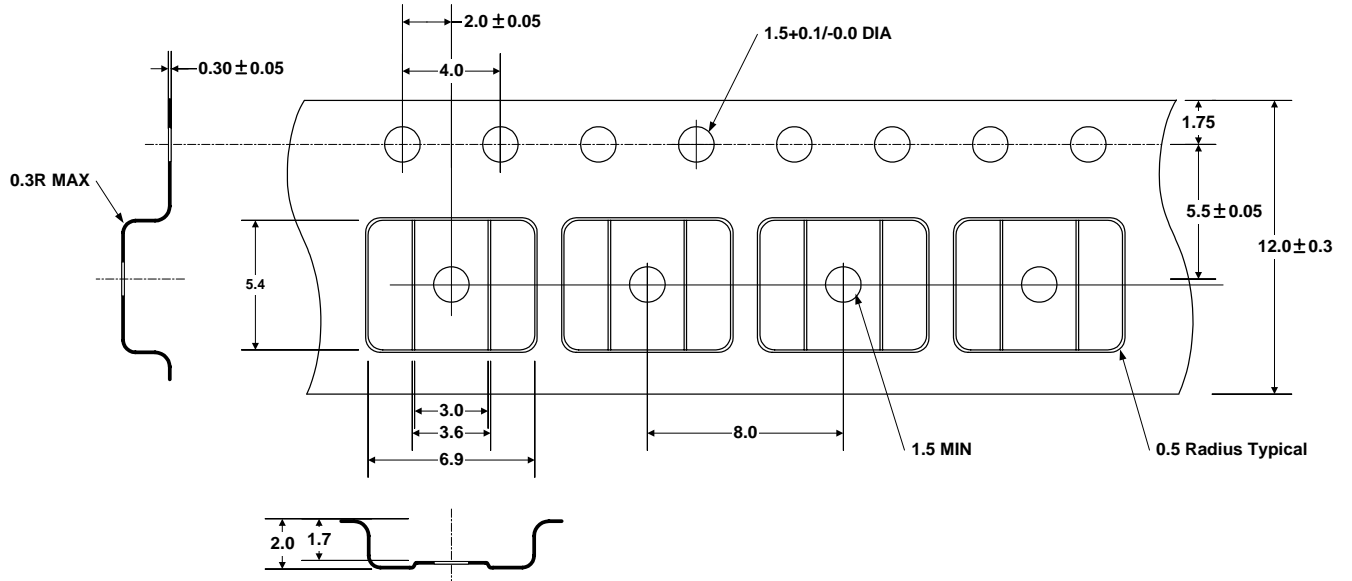

**MSOP8**

### ORDERING INFORMATION

Package	Part number	Packaging Marking	Transport Media
8-Pin SOP	MSV358TR	MSV358	2.5k Units Tape and Reel
8-Pin SOP	MSV358U	MSV358	100 Units Tube
8-Pin SOP (lead free)	MSV358GTR	MSV358G	2.5k Units Tape and Reel
8-Pin SOP (lead free)	MSV358GU	MSV358G	100 Units Tube
8-Pin MSOP	MSV358MTR	V358	3.5k Units Tape and Reel
8-Pin MSOP	MSV358MU	V358	80 Units Tube
8-Pin MSOP (lead free)	MSV358MGTR	V358G	3.5k Units Tape and Reel
8-Pin MSOP (lead free)	MSV358MGU	V358G	80 Units Tube