



Low-Noise, Low-Dropout, 150mA Linear Regulators with '2982 Pinout

MAX8877/MAX8878

General Description

The MAX8877/MAX8878 low-noise, low-dropout linear regulators operate from a 2.5V to 6.5V input and deliver up to 150mA. These devices are pin-compatible with the industry-standard '2982 and offer an improved dropout voltage. Typical output noise is 30 μ V_{RMS}, and typical dropout is only 165mV at 150mA. The output voltage is preset to voltages in the range of 1.5V to 5.0V, in 100mV increments.

Designed with an internal P-channel MOSFET pass transistor, the MAX8877/MAX8878 maintain a low 100 μ A supply current, independent of the load current and dropout voltage. Other features include a 10nA logic-controlled shutdown mode, short-circuit and thermal-shutdown protection, and reverse battery protection. The MAX8878 also includes an auto-discharge function, which actively discharges the output voltage to ground when the device is placed in shutdown. Both devices come in regular and thin 5-pin SOT23 packages.

Applications

Cellular Telephones
Cordless Telephones
PCS Telephones
PCMCIA Cards
Modems
Hand-Held Instruments
Palmtop Computers
Electronic Planners

Features

- ◆ Pin-Compatible with the Industry-Standard '2982
- ◆ Low Output Noise: 30 μ V_{RMS}
- ◆ Low 55mV Dropout at 50mA Output (165mV at 150mA output)
- ◆ Low 85 μ A No-Load Supply Current
- ◆ Low 100 μ A Operating Supply Current (even in dropout)
- ◆ Thermal-Overload and Short-Circuit Protection
- ◆ Reverse Battery Protection
- ◆ Output Current Limit
- ◆ Preset Output Voltages (\pm 1.4% Accuracy)
- ◆ 10nA Logic-Controlled Shutdown

Ordering Information

PART**	TEMP. RANGE	PIN-PACKAGE
MAX8877C/Dxy	0°C to +70°C	Dice*
MAX8877EUKxy-T	-40°C to +85°C	5 SOT23-5 Regular
MAX8877EZKxy-T	-40°C to +85°C	5 SOT23-5 Thin
MAX8878C/Dxy	0°C to +70°C	Dice*
MAX8878EUKxy-T	-40°C to +85°C	5 SOT23-5 Regular
MAX8878EZKxy-T	-40°C to +85°C	5 SOT23-5 Thin

*Dice are tested at $T_A = +25^\circ\text{C}$ only.

**xy is the output voltage code (see Expanded Ordering Information table at end of data sheet).

Typical Operating Circuit

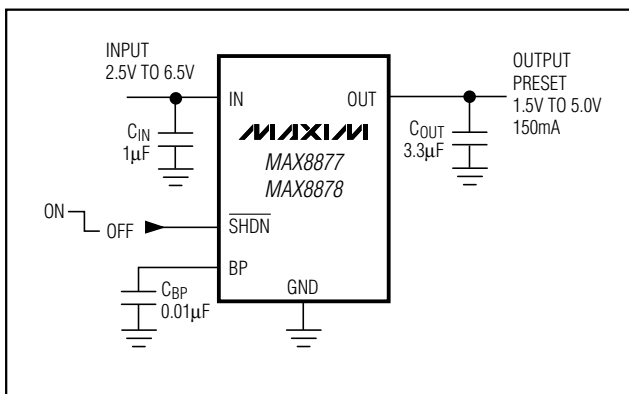

Pin Configuration

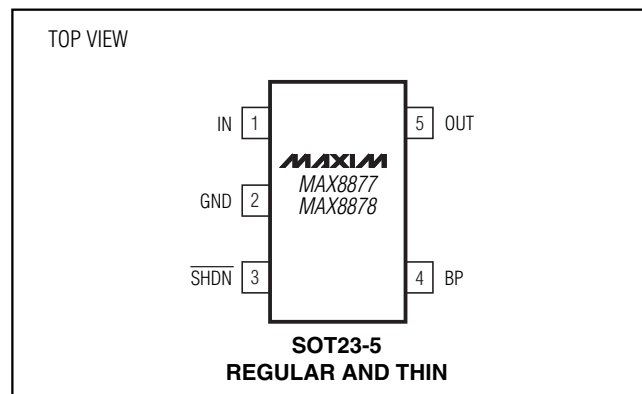

Low-Noise, Low-Dropout, 150mA Linear Regulators with '2982 Pinout

ABSOLUTE MAXIMUM RATINGS

IN to GND-7V to +7V
 Output Short-Circuit DurationInfinite
 $\overline{\text{SHDN}}$ to GND.....-7V to +7V
 $\overline{\text{SHDN}}$ to IN.....-7V to +0.3V
 OUT, BP to GND-0.3V to ($V_{\text{IN}} + 0.3\text{V}$)
 Continuous Power Dissipation ($T_A = +70^\circ\text{C}$)
 SOT23-5 Regular (derate 7.1mW/ $^\circ\text{C}$ above +70 $^\circ\text{C}$)571mW

SOT23-5 Thin (derate 9.1mW/ $^\circ\text{C}$ above +70 $^\circ\text{C}$)727mW
 Operating Temperature Range-40 $^\circ\text{C}$ to +85 $^\circ\text{C}$
 Junction Temperature+150 $^\circ\text{C}$
 θ_{JB} (Regular).....140 $^\circ\text{C}/\text{W}$
 θ_{JB} (Thin).....110 $^\circ\text{C}/\text{W}$
 Storage Temperature.....-65 $^\circ\text{C}$ to +150 $^\circ\text{C}$
 Lead Temperature (soldering, 10s)+300 $^\circ\text{C}$

Stresses beyond those listed under "Absolute Maximum Ratings" may cause permanent damage to the device. These are stress ratings only, and functional operation of the device at these or any other conditions beyond those indicated in the operational sections of the specifications is not implied. Exposure to absolute maximum rating conditions for extended periods may affect device reliability.

ELECTRICAL CHARACTERISTICS

($V_{\text{IN}} = V_{\text{OUT(NOMINAL)}} + 0.5\text{V}$ or 2.5V (whichever is greater), $T_A = -40^\circ\text{C}$ to +85 $^\circ\text{C}$, unless otherwise noted. Typical values are at $T_A = +25^\circ\text{C}$.) (Note 1)

PARAMETER	SYMBOL	CONDITIONS	MIN	TYP	MAX	UNITS
Input Voltage	V_{IN}		2.5		6.5	V
Output Voltage Accuracy		$I_{\text{OUT}} = 0.1\text{mA}$, $T_A = +25^\circ\text{C}$, $V_{\text{OUT}} \geq 2.5\text{V}$	-1.4		1.4	%
		$I_{\text{OUT}} = 0.1\text{mA}$ to 120mA, $T_A = -40^\circ\text{C}$ to +85 $^\circ\text{C}$, $V_{\text{OUT}} \geq 2.5\text{V}$	-3		2	
		$I_{\text{OUT}} = 0.1\text{mA}$, $T_A = +25^\circ\text{C}$, $V_{\text{OUT}} < 2.5\text{V}$	-3		3	
		$I_{\text{OUT}} = 0.1\text{mA}$ to 120mA, $T_A = -40^\circ\text{C}$ to +85 $^\circ\text{C}$, $V_{\text{OUT}} < 2.5\text{V}$	-3.5		3.5	
Maximum Output Current			150			mA
Current Limit	I_{LIM}		160	390		mA
Ground Pin Current	I_{Q}	No load		85	180	μA
		$I_{\text{OUT}} = 150\text{mA}$		100		
Dropout Voltage (Note 2)		$I_{\text{OUT}} = 1\text{mA}$		1.1		mV
		$I_{\text{OUT}} = 50\text{mA}$		55	120	
		$I_{\text{OUT}} = 150\text{mA}$		165		
Line Regulation	ΔV_{LNR}	$V_{\text{IN}} = 2.5\text{V}$ or ($V_{\text{OUT}} + 0.1\text{V}$) to 6.5V, $I_{\text{OUT}} = 1\text{mA}$	-0.15	0	0.15	%/V
Load Regulation	ΔV_{LDR}	$I_{\text{OUT}} = 0.1\text{mA}$ to 120mA, $C_{\text{OUT}} = 1\mu\text{F}$		0.01	0.04	%/mA
Output Voltage Noise	e_{n}	$f = 10\text{Hz}$ to 100kHz, $C_{\text{BP}} = 0.01\mu\text{F}$	$C_{\text{OUT}} = 10\mu\text{F}$		30	μVRMS
			$C_{\text{OUT}} = 100\mu\text{F}$		20	
SHUTDOWN						
$\overline{\text{SHDN}}$ Input Threshold	V_{IH}	$V_{\text{IN}} = 2.5\text{V}$ to 5.5V	2.0			V
	V_{IL}	$V_{\text{IN}} = 2.5\text{V}$ to 5.5V			0.4	
$\overline{\text{SHDN}}$ Input Bias Current	I_{SHDN}	$V_{\text{SHDN}} = V_{\text{IN}}$	$T_A = +25^\circ\text{C}$	0.01	100	μA
			$T_A = +85^\circ\text{C}$	0.5		
Shutdown Supply Current	$I_{\text{Q(SHDN)}}$	$V_{\text{OUT}} = 0\text{V}$	$T_A = +25^\circ\text{C}$	0.01	1	μA
			$T_A = +85^\circ\text{C}$	0.2		
Shutdown Exit Delay (Note 3)		$C_{\text{BP}} = 0.1\mu\text{F}$, $C_{\text{OUT}} = 1\mu\text{F}$, no load	$T_A = +25^\circ\text{C}$	30	150	μs
			$T_A = -40^\circ\text{C}$ to +85 $^\circ\text{C}$		300	
Resistance Shutdown Discharge		MAX8878 only		300		Ω

Low-Noise, Low-Dropout, 150mA Linear Regulators with '2982 Pinout

ELECTRICAL CHARACTERISTICS (continued)

($V_{IN} = V_{OUT(NOMINAL)} + 0.5V$ or $2.5V$ (whichever is greater), $T_A = -40^{\circ}C$ to $+85^{\circ}C$, unless otherwise noted. Typical values are at $T_A = +25^{\circ}C$.) (Note 1)

PARAMETER	SYMBOL	CONDITIONS	MIN	TYP	MAX	UNITS
THERMAL PROTECTION						
Thermal Shutdown Temperature	T_{SHDN}			155		$^{\circ}C$
Thermal Shutdown Hysteresis	ΔT_{SHDN}			15		$^{\circ}C$

Note 1: Limits are 100% production tested at $T_A = +25^{\circ}C$. Limits over the operating temperature range are guaranteed through correlation using Statistical Quality Control (SQC) Methods.

Note 2: The dropout voltage is defined as $V_{IN} - V_{OUT}$, when V_{OUT} is 100mV below the value of V_{OUT} for $V_{IN} = V_{OUT} + 0.5V$. (Only applicable for $V_{OUT} = +2.5V$ to $+5V$.)

Note 3: Time needed for V_{OUT} to reach 95% of final value.

Typical Operating Characteristics

($V_{IN} = V_{OUT(NOMINAL)} + 0.5V$ or $2.5V$ (whichever is greater), $C_{IN} = 1\mu F$, $C_{OUT} = 1\mu F$, $C_{BP} = 0.01\mu F$, $T_A = +25^{\circ}C$, unless otherwise noted.)

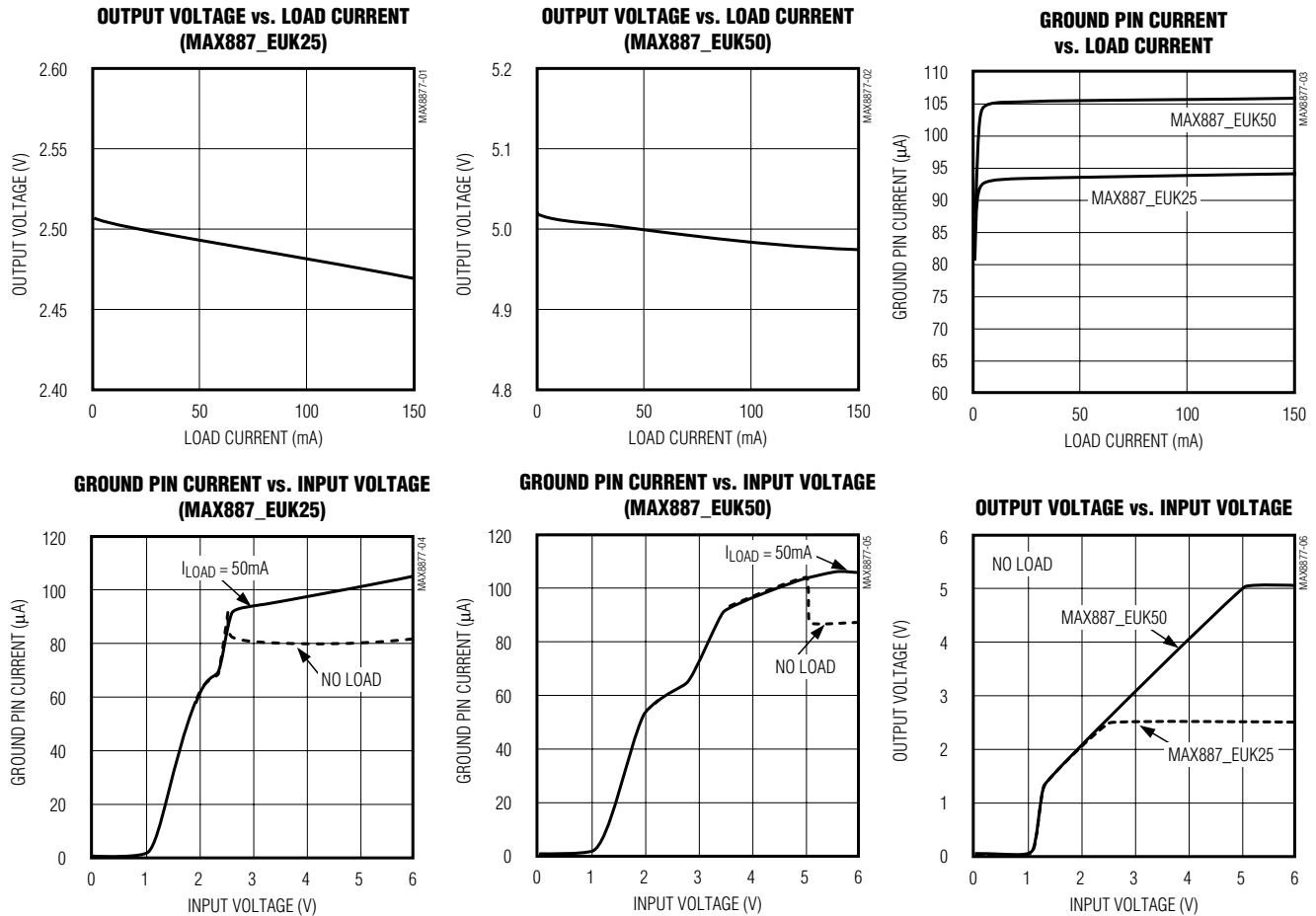

Low-Noise, Low-Dropout, 150mA Linear Regulators with '2982 Pinout

Typical Operating Characteristics (continued)

($V_{IN} = V_{OUT(NOMINAL)} + 0.5V$ or $2.5V$ (whichever is greater), $C_{IN} = 1\mu F$, $C_{OUT} = 1\mu F$, $C_{BP} = 0.01\mu F$, $T_A = +25^\circ C$, unless otherwise noted.)

OUTPUT VOLTAGE vs. TEMPERATURE (MAX887_EUK25)

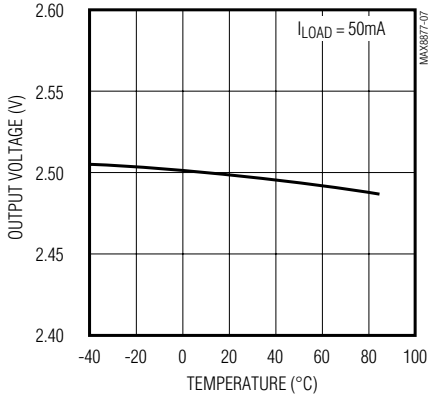

OUTPUT VOLTAGE vs. TEMPERATURE (MAX887_EUK50)

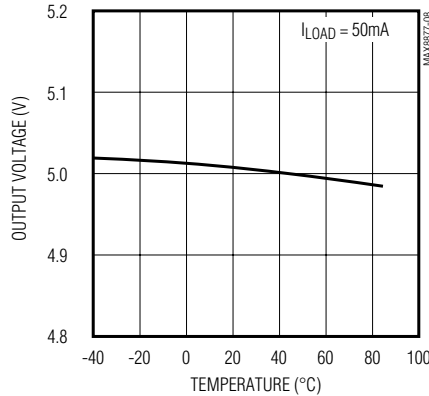

GROUND PIN CURRENT vs. TEMPERATURE

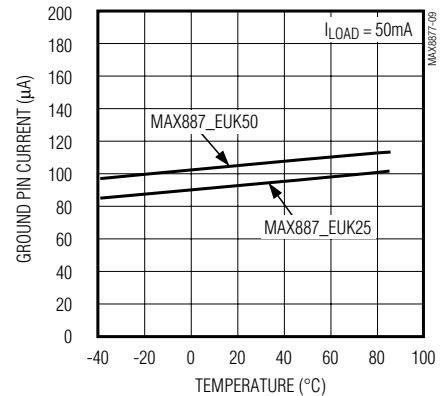

DROPOUT VOLTAGE vs. LOAD CURRENT (MAX887_EUK25)

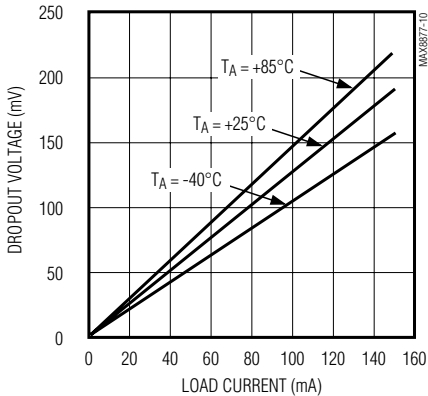

DROPOUT VOLTAGE vs. LOAD CURRENT (MAX887_EUK50)

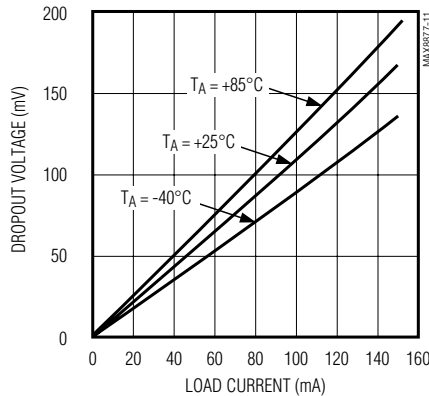

POWER-SUPPLY REJECTION RATIO vs. FREQUENCY

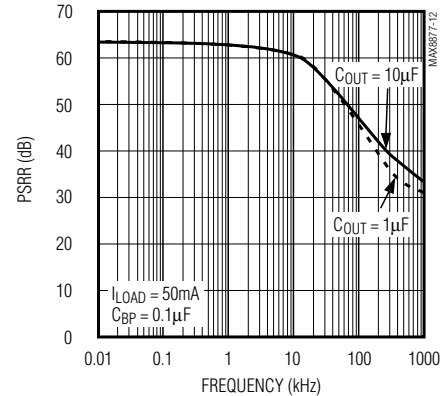

OUTPUT NOISE SPECTRAL DENSITY vs. FREQUENCY

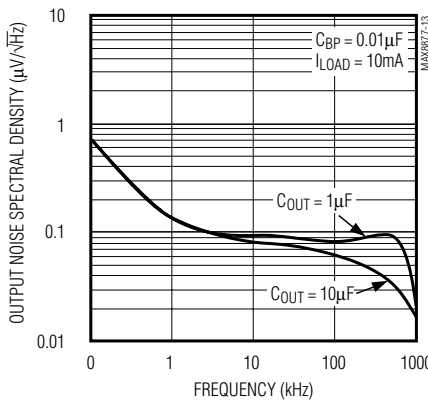

OUTPUT NOISE vs. BP CAPACITANCE

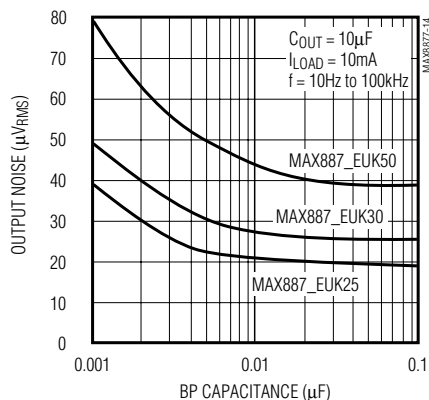

OUTPUT NOISE vs. LOAD CURRENT

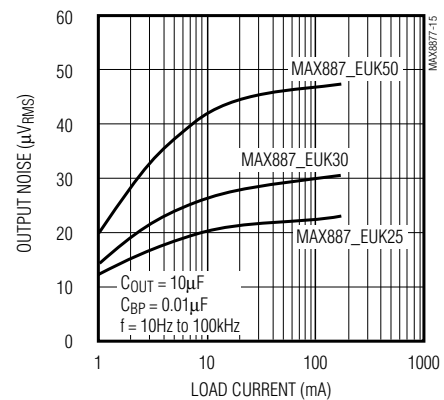

Low-Noise, Low-Dropout, 150mA Linear Regulators with '2982 Pinout

MAX8877/MAX8878

Typical Operating Characteristics (continued)

($V_{IN} = V_{OUT(NOMINAL)} + 0.5V$ or $2.5V$ (whichever is greater), $C_{IN} = 1\mu F$, $C_{OUT} = 1\mu F$, $C_{BP} = 0.01\mu F$, $T_A = +25^\circ C$, unless otherwise noted.)

OUTPUT NOISE 10Hz TO 100kHz

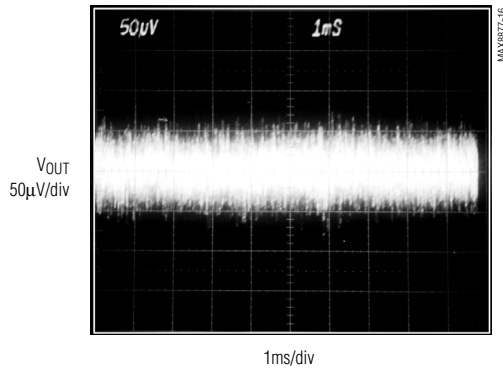

MAX887-EUK25, $C_{OUT} = 10\mu F$, $I_{LOAD} = 10mA$, $C_{BP} = 0.1\mu F$

REGION OF STABLE C_{OUT} ESR vs. LOAD CURRENT

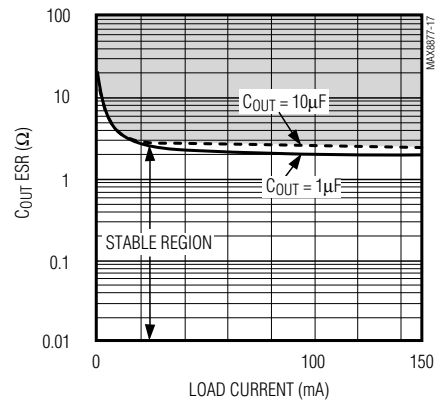

LINE-TRANSIENT RESPONSE

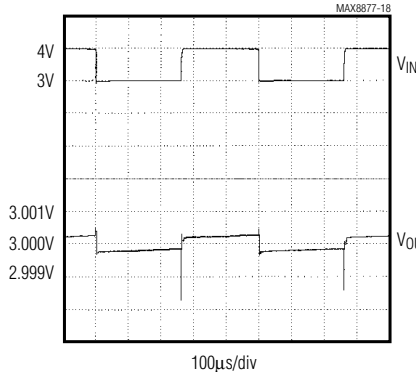

MAX887-EUK30, $I_{LOAD} = 50mA$

LOAD-TRANSIENT RESPONSE

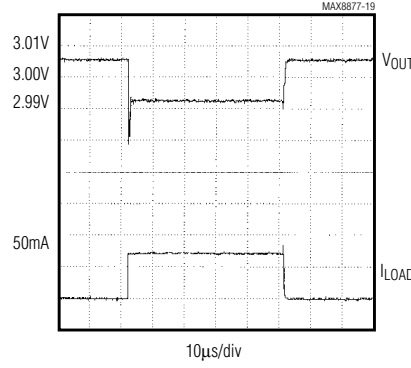

MAX887-EUK30, $V_{IN} = V_{OUT} + 0.5V$, $C_{IN} = 10\mu F$, $I_{LOAD} = 0mA$ TO $50mA$

LOAD-TRANSIENT RESPONSE NEAR DROPOUT

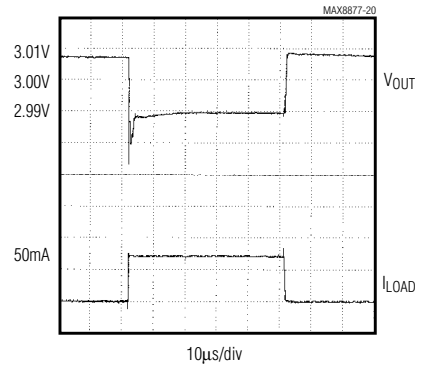

MAX887-EUK30, $V_{IN} = V_{OUT} + 0.1V$, $C_{IN} = 10\mu F$, $I_{LOAD} = 0mA$ TO $50mA$

MAX887-EUK25 SHUTDOWN EXIT DELAY

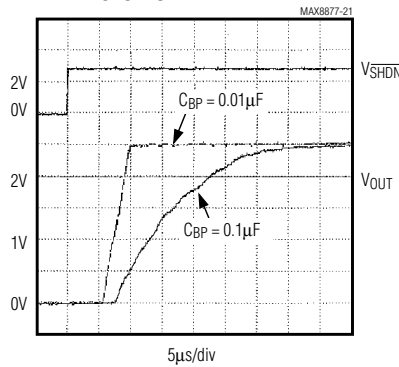

MAX887-EUK25, $I_{LOAD} = 50mA$

MAX887-EUK50 SHUTDOWN EXIT DELAY

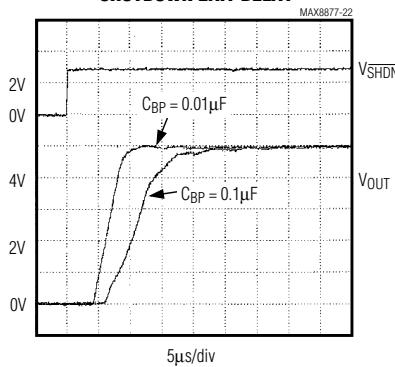

MAX887-EUK50, $I_{LOAD} = 50mA$

ENTERING SHUTDOWN

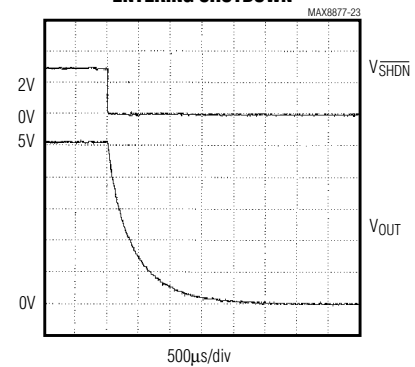

MAX8878, NO LOAD

Low-Noise, Low-Dropout, 150mA Linear Regulators with '2982 Pinout

Pin Description

PIN	NAME	FUNCTION
1	IN	Regulator Input. Supply voltage can range from 2.5V to 6.5V. Bypass with a 1 μ F capacitor to GND (see <i>Capacitor Selection and Regulator Stability</i> section).
2	GND	Ground. This pin also functions as a heatsink. Solder to a large pad or the circuit-board ground plane to maximize power dissipation.
3	$\overline{\text{SHDN}}$	Active-Low Shutdown Input. A logic low reduces the supply current to 10nA. On the MAX8878, a logic low also causes the output voltage to discharge to GND. Connect to IN for normal operation.
4	BP	Reference-Noise Bypass. Bypass with a low-leakage, 0.01 μ F ceramic capacitor for reduced noise at the output.
5	OUT	Regulator Output. Sources up to 150mA. Bypass with a 1 μ F (<0.2 Ω typical ESR) capacitor to GND for $V_{\text{OUT}} \geq 2.5\text{V}$ and 3.3 μ F for $V_{\text{OUT}} < 2.5\text{V}$.

Detailed Description

The MAX8877/MAX8878 are low-noise, low-dropout, low-quiescent-current linear regulators designed primarily for battery-powered applications. The parts are available with preset output voltages ranging from 1.5V to 5V, in 100mV increments. These devices can supply loads up to 150mA. As illustrated in Figure 1, the MAX8877/MAX8878 consist of a 1.25V reference, error amplifier, P-channel pass transistor, and internal feedback voltage divider.

The 1.25V bandgap reference is connected to the error amplifier's inverting input. The error amplifier compares this reference with the feedback voltage and amplifies the difference. If the feedback voltage is lower than the

reference voltage, the pass-transistor gate is pulled lower, which allows more current to pass to the output and increases the output voltage. If the feedback voltage is too high, the pass-transistor gate is pulled up, allowing less current to pass to the output. The output voltage is fed back through an internal resistor voltage divider connected to the OUT pin.

An external bypass capacitor connected to the BP pin reduces noise at the output. Additional blocks include a current limiter, reverse battery protection, thermal sensor, and shutdown logic. The MAX8878 also includes an auto-discharge function, which actively discharges the output voltage to ground when the device is placed in shutdown mode.

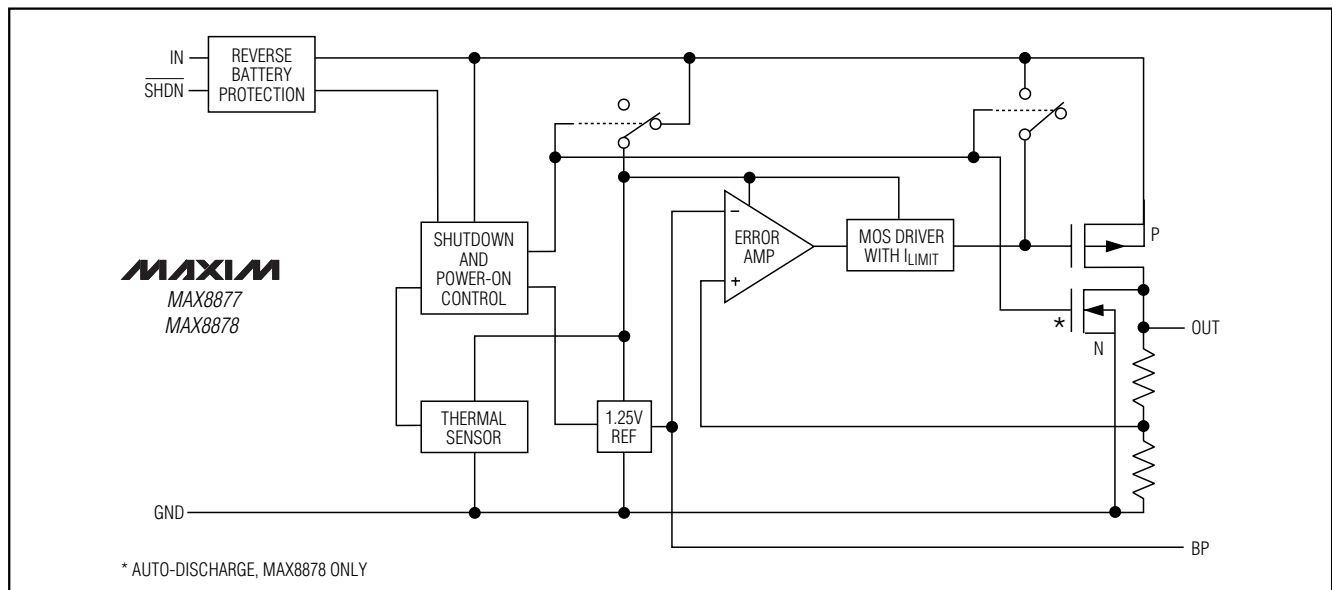

Figure 1. Functional Diagram

Low-Noise, Low-Dropout, 150mA Linear Regulators with '2982 Pinout

MAX8877/MAX8878

Output Voltage

The MAX8877/MAX8878 are supplied with factory-set output voltages from 1.5V to 5.0V, in 100mV increments. Except for the MAX887_EUK29 and the MAX887_EUK32 (which have an output voltage preset at 2.84V and 3.15V, respectively), the two-digit suffix allows the customer to choose the output voltage in 100mV increments. For example, the MAX8877EUK33 has a preset output voltage of 3.3V (see *Expanded Ordering Information*).

Internal P-Channel Pass Transistor

The MAX8877/MAX8878 feature a 1.1 Ω typical P-channel MOSFET pass transistor. This provides several advantages over similar designs using PNP pass transistors, including longer battery life. The P-channel MOSFET requires no base drive, which reduces quiescent current considerably. PNP-based regulators waste considerable current in dropout when the pass transistor saturates. They also use high base-drive currents under large loads. The MAX8877/MAX8878 do not suffer from these problems and consume only 100 μ A of quiescent current whether in dropout, light-load, or heavy-load applications (see the *Typical Operating Characteristics*).

Current Limit

The MAX8877/MAX8878 include a current limiter, which monitors and controls the pass transistor's gate voltage, limiting the output current to 390mA. For design purposes, consider the current limit to be 160mA minimum to 500mA maximum. The output can be shorted to ground for an indefinite amount of time without damaging the part.

Thermal-Overload Protection

Thermal-overload protection limits total power dissipation in the MAX8877/MAX8878. When the junction temperature exceeds $T_J = +155^\circ\text{C}$, the thermal sensor signals the shutdown logic, turning off the pass transistor and allowing the IC to cool. The thermal sensor will turn the pass transistor on again after the IC's junction temperature cools by 15°C , resulting in a pulsed output during continuous thermal-overload conditions.

Thermal-overload protection is designed to protect the MAX8877/MAX8878 in the event of fault conditions. For continual operation, do not exceed the absolute maximum junction-temperature rating of $T_J = +150^\circ\text{C}$.

Operating Region and Power Dissipation

The MAX8877/MAX8878's maximum power dissipation depends on the thermal resistance of the case and circuit board, the temperature difference between the die junction and ambient air, and the rate of air flow. The power dissipation across the device is $P = I_{\text{OUT}} (V_{\text{IN}} - V_{\text{OUT}})$. The maximum power dissipation is:

$$P_{\text{MAX}} = (T_J - T_A) / (\theta_{\text{JB}} + \theta_{\text{BA}})$$

where $T_J - T_A$ is the temperature difference between the MAX8877/MAX8878 die junction and the surrounding air, θ_{JB} (or θ_{JC}) is the thermal resistance of the package, and θ_{BA} is the thermal resistance through the printed circuit board, copper traces, and other materials to the surrounding air.

The GND pin of the MAX8877/MAX8878 performs the dual function of providing an electrical connection to ground and channeling heat away. Connect the GND pin to ground using a large pad or ground plane.

Reverse Battery Protection

The MAX8877/MAX8878 have a unique protection scheme that limits the reverse supply current to 1mA when either V_{IN} or V_{SHDN} falls below ground. Their circuitry monitors the polarity of these two pins and disconnects the internal circuitry and parasitic diodes when the battery is reversed. This feature prevents device damage.

Noise Reduction

An external 0.01 μ F bypass capacitor at BP, in conjunction with an internal 200k Ω resistor, creates a 80Hz low-pass filter for noise reduction. The MAX8877/MAX8878 exhibit 30 μ V_{RMS} of output voltage noise with $C_{\text{BP}} = 0.01\mu\text{F}$ and $C_{\text{OUT}} = 10\mu\text{F}$. This is negligible in most applications. Start-up time is minimized by a power-on circuit that pre-charges the bypass capacitor. The *Typical Operating Characteristics* section shows graphs of Noise vs. BP Capacitance, Noise vs. Load Current, and Output Noise Spectral Density.

Applications Information

Capacitor Selection and Regulator Stability

Normally, use a 1 μ F capacitor on the MAX8877/MAX8878's input and a 1 μ F to 10 μ F capacitor on the output. Larger input capacitor values and lower ESRs provide better supply-noise rejection and line-transient response. Reduce noise and improve load-transient response, stability, and power-supply rejection by using large output capacitors. For stable operation over the full temperature range and with load currents up to 150mA, a 1 μ F (min) ceramic capacitor is recommended for $V_{\text{OUT}} \geq 2.5\text{V}$ and 3.3 μ F and for $V_{\text{OUT}} < 2.5\text{V}$.

Note that some ceramic dielectrics exhibit large capacitance and ESR variation with temperature. With dielectrics such as Z5U and Y5V, it may be necessary to increase the capacitance by a factor of 2 or more to ensure stability at temperatures below -10°C . With X7R or X5R dielectrics, 1 μ F should be sufficient at all operating temperatures for $V_{\text{OUT}} \geq 2.5\text{V}$. A graph of the Region of

Low-Noise, Low-Dropout, 150mA Linear Regulators with '2982 Pinout

Stable C_{OUT} ESR vs. Load Current is shown in the *Typical Operating Characteristics*.

Use a 0.01μF bypass capacitor at BP for low output voltage noise. Increasing the capacitance will slightly decrease the output noise, but increase the start-up time. Values above 0.1μF provide no performance advantage and are not recommended (see Shutdown Exit Delay graphs in the *Typical Operating Characteristics*).

PSRR and Operation from Sources Other than Batteries

The MAX8877/MAX8878 are designed to deliver low dropout voltages and low quiescent currents in battery-powered systems. Power-supply rejection is 63dB at low frequencies and rolls off above 10kHz. See the Power-Supply Rejection Ratio Frequency graph in the *Typical Operating Characteristics*.

When operating from sources other than batteries, improved supply-noise rejection and transient response can be achieved by increasing the values of the input and output bypass capacitors, and through passive filtering techniques. The *Typical Operating Characteristics* show the MAX8877/MAX8878's line- and load-transient responses.

Load-Transient Considerations

The MAX8877/MAX8878 load-transient response graphs (see *Typical Operating Characteristics*) show

two components of the output response: a DC shift from the output impedance due to the load current change, and the transient response. Typical transient for a step change in the load current from 0mA to 50mA is 12mV. Increasing the output capacitor's value and decreasing the ESR attenuates the overshoot.

Input-Output (Dropout) Voltage

For output voltage greater than the minimum input voltage (2.5V), the regulator's minimum input-output voltage differential (or dropout voltage) determines the lowest usable supply voltage. In battery-powered systems, this will determine the useful end-of-life battery voltage. Because the MAX8877/MAX8878 use a P-channel MOSFET pass transistor, their dropout voltage is a function of drain-to-source on-resistance (R_{DS(ON)}) multiplied by the load current (see *Typical Operating Characteristics*).

Chip Information

TRANSISTOR COUNT: 247

SUBSTRATE CONNECTED TO GND

Expanded Ordering Information

OUTPUT VOLTAGE (xy) CODE		PRESET OUTPUT VOLTAGE (V)	SOT TOP MARK			
REGULAR SOT23	THIN SOT23		MAX8877 REGULAR	MAX8877 THIN	MAX8878 REGULAR	MAX8878 THIN
MAX887_EUK15-T	MAX887_EZK15-T	1.50	ADRG	AAAA	ADQV	AAAJ
MAX887_EUK18-T	MAX887_EZK18-T	1.80	ADQT	AAAB	ADRH	AAAK
MAX887_EUK25-T	MAX887_EZK25-T	2.50	ACBM	AAAC	ACBT	AAAL
MAX887_EUK28-T	MAX887_EZK28-T	2.80	ACBN	AAAD	ACBU	AAAM
MAX887_EUK29-T	MAX887_EZK29-T	2.84	ACBO	ADPM	ACBV	ADPO
MAX887_EUK30-T	MAX887_EZK30-T	3.00	ACBP	AAAE	ACBW	AAAN
MAX887_EUK32-T	MAX887_EZK32-T	3.15	ACBQ	AAAF	ACBX	AAAO
MAX887_EUK33-T	MAX887_EZK33-T	3.30	ACBR	AAAG	ACBY	AAAP
MAX887_EUK36-T	MAX887_EZK36-T	3.60	ACDB	AAAH	ACDC	AAAQ
MAX887_EUK50-T	MAX887_EZK50-T	5.00	ACBS	AAAI	ACBZ	AAAR
Other xy***		x.y0	—	—	—	—

***Other xy between 1.5V and 5.0V are available in 100mV increments. Contact factory for other versions. Minimum order quantity is 25,000 units.

Low-Noise, Low-Dropout, 150mA Linear Regulators with '2982 Pinout

Package Information

MAX8877/MAX8878

SOT23LPS

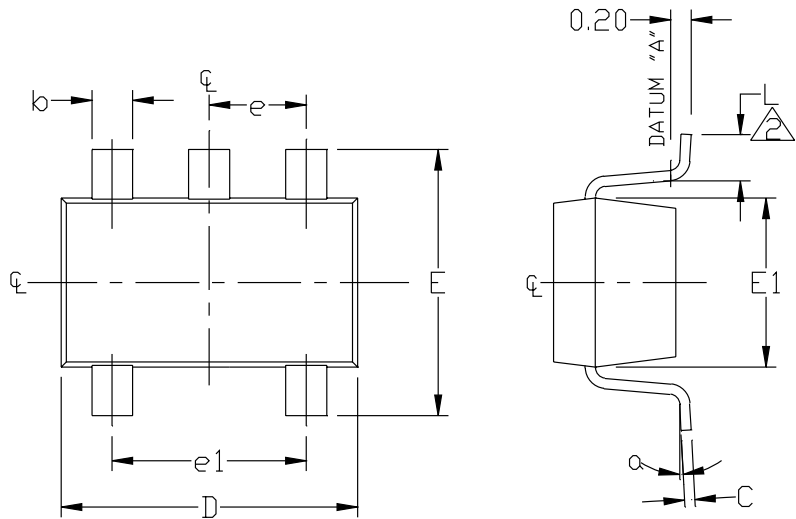

SYMBOL	MIN	MAX
A	0.90	1.45
A1	0.00	0.15
A2	0.90	1.30
b	0.35	0.50
C	0.08	0.20
D	2.80	3.00
E	2.60	3.00
E1	1.50	1.75
L	0.35	0.55
e	0.95 REF	
e1	1.90 REF	
a	0°	10°

NOTE:

1. ALL DIMENSIONS ARE IN MILLIMETERS.
2. FOOT LENGTH MEASURED AT INTERCEPT POINT BETWEEN DATUM A & LEAD SURFACE.
3. PACKAGE OUTLINE EXCLUSIVE OF MOLD FLASH & METAL BURR.
4. PACKAGE OUTLINE INCLUSIVE OF SOLDER PLATING.

MAXIM		
<small>PROPRIETARY INFORMATION</small>		
<small>TITLE:</small>		
PACKAGE OUTLINE, SOT23, 5L		
<small>APPROVAL</small>	<small>DOCUMENT CONTROL NO</small>	<small>REV</small>
	21-0057	B 1/1

Low-Noise, Low-Dropout, 150mA Linear Regulators with '2982 Pinout

Package Information (continued)

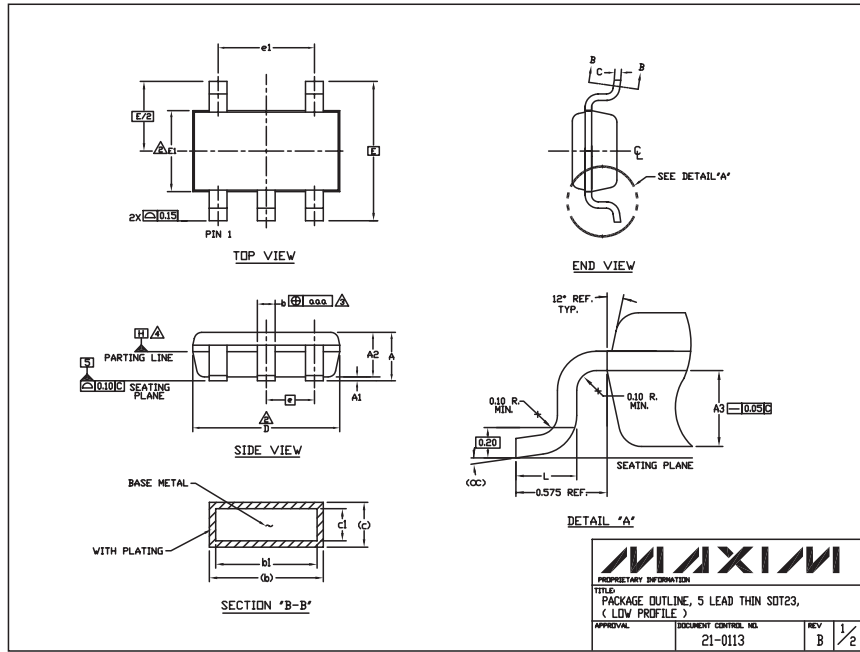

NOTES:

- ALL DIMENSIONS ARE IN MILLIMETERS.
- "D" AND "E1" ARE REFERENCE DATUM AND DO NOT INCLUDE MOLD FLASH OR PROTRUSIONS, AND ARE MEASURED AT THE BOTTOM PARTING LINE. MOLD FLASH OR PROTRUSION SHALL NOT EXCEED 0.15mm ON "D" AND 0.25mm ON "E" PER SIDE.
- THE LEAD WIDTH DIMENSION DOES NOT INCLUDE DAMBAR PROTRUSION. ALLOWABLE DAMBAR PROTRUSION SHALL BE 0.07mm TOTAL IN EXCESS OF THE LEAD WIDTH DIMENSION AT MAXIMUM MATERIAL CONDITION.
- DATUM PLANE "H" LOCATED AT MOLD PARTING LINE AND COINCIDENT WITH LEAD, WHERE LEAD EXITS PLASTIC BODY AT THE BOTTOM OF PARTING LINE.
- THE LEAD TIPS MUST LINE WITHIN A SPECIFIED TOLERANCE ZONE. THIS TOLERANCE ZONE IS DEFINED BY TWO PARALLEL LINES. ONE PLANE IS THE SEATING PLANE, DATUM [-C-]; AND THE OTHER PLANE IS AT THE SPECIFIED DISTANCE FROM [-C-] IN THE DIRECTION INDICATED. FORMED LEADS SHALL BE PLANAR WITH RESPECT TO ONE ANOTHER WITH 0.10mm AT SEATING PLANE.
- THIS PART IS COMPLIANT WITH JEDEC SPECIFICATION MO-193 EXCEPT FOR THE "e" DIMENSION WHICH IS 0.95mm INSTEAD OF 1.00mm. THIS PART IS IN FULL COMPLIANCE TO EIAJ SPECIFICATION SC-74.

SYMBOLS			
	MIN	NDM	MAX
A	-	-	1.10
A1	0.05	0.075	0.10
A2	0.85	0.88	0.90
A3	0.50 BSC		
b	0.30	-	0.45
b1	0.25	0.35	0.40
c	0.15	-	0.20
c1	0.12	0.127	0.15
D	2.80	2.90	3.00
E	2.75 BSC		
E1	1.55	1.60	1.65
L	0.30	0.40	0.50
e1	1.90 BSC		
e	0.95 BSC		
CC	0°	4°	8°
o.o.o	0.20		

MAXIM
PROPRIETARY INFORMATION
 TITLE: PACKAGE OUTLINE, 5 LEAD THIN SOT23, (LOW PROFILE)
 APPROVAL: _____ DOCUMENT CONTROL NO. 21-0113 REV B 2/2

Maxim cannot assume responsibility for use of any circuitry other than circuitry entirely embodied in a Maxim product. No circuit patent licenses are implied. Maxim reserves the right to change the circuitry and specifications without notice at any time.

10 **Maxim Integrated Products, 120 San Gabriel Drive, Sunnyvale, CA 94086 408-737-7600**