

3 Channel Headset EMI Filter with ESD Protection

Features

- Three channels of EMI filtering, two for earpiece speakers and one for a microphone
- Pi-style EMI filters in a capacitor-resistor-capacitor (C-R-C) network
- Chip Scale Package features extremely low parasitic inductance for optimum filter performance
- Greater than 30dB relative attenuation in the 800-2700MHz range
- $\pm 8\text{kV}$ ESD protection on each channel (IEC 61000-4-2 Level 4, contact discharge)
- $\pm 15\text{kV}$ ESD protection on each channel (HBM)
- 8-bump, 1.41mm X 1.45mm footprint
Chip Scale Package (CSP)

Applications

- EMI filtering and ESD protection for headset microphone and speaker
- Cellular / Mobile Phones
- Notebooks and Personal Computers
- Handheld PCs / PDAs / Tablets
- Wireless Handsets
- Digital Camcorders

Product Description

The CSPEMI205 is a low-pass filter array integrating three pi-style filters (C-R-C) that reduce EMI/RFI emissions while at the same time providing ESD protection. This device is custom-designed to interface with the headset port on a cellular telephone, and contains two different filter values. Each high quality filter provides more than 30dB attenuation in the 800-2700 MHz range. These pi-style filters support bidirectional filtering, controlling EMI both to and from the microphone and speaker elements. They also support bipolar signals, enabling audio signals to pass through without distortion.

In addition, the CSPEMI205 provides a very high level of protection for sensitive electronic components that may be subject to electrostatic discharge (ESD). The input pins are designed and characterized to safely dissipate ESD strikes of $\pm 8\text{kV}$, the maximum requirement of the IEC 61000-4-2 international standard. Using the MIL-STD-883 (Method 3015) specification for Human Body Model (HBM) ESD, the device provides protection for contact discharges to greater than $\pm 15\text{kV}$.

The CSPEMI205 is particularly well suited for portable electronics (e.g., cellular telephones, PDAs, notebook computers) because of its small package format and low weight. This device is available in a space-saving, low-profile Chip Scale Package, and is fabricated with California Micro Devices' semiconductor processes for reliability equalling today's IC devices.

Electrical Schematic

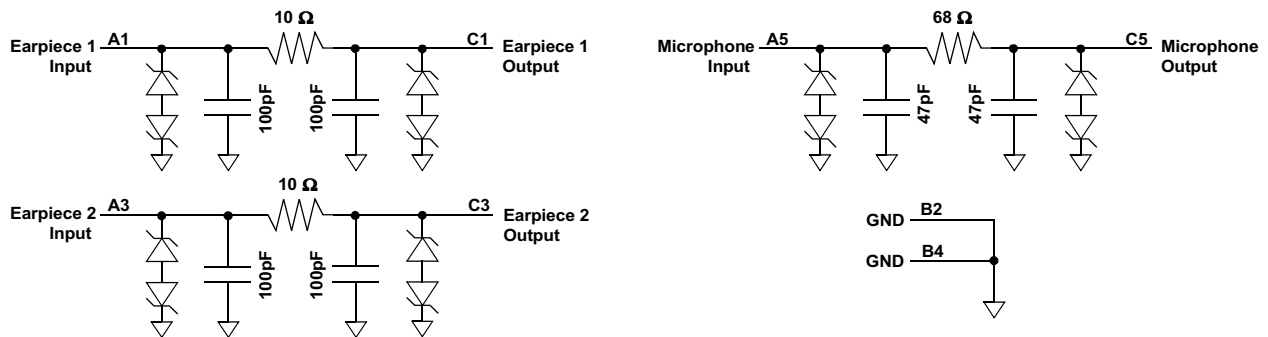



PACKAGE / PINOUT DIAGRAMS

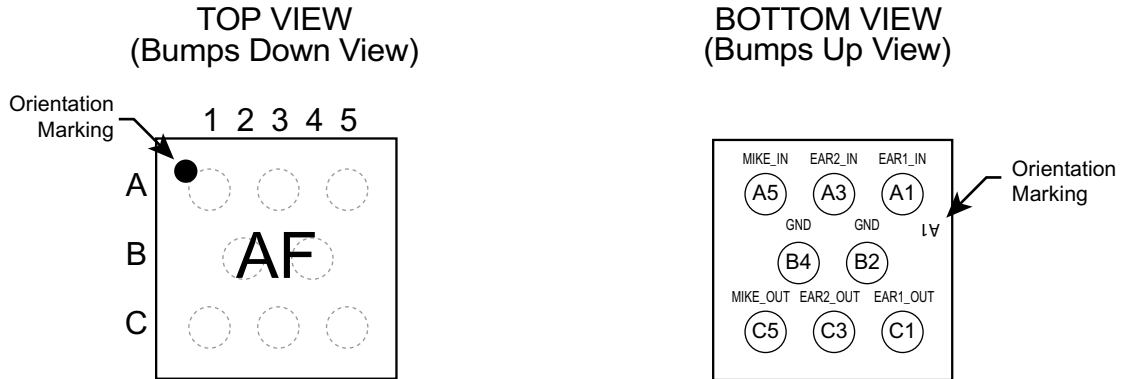

Note: These drawings are not to scale.

CSPEMI205
CSP Package

PIN DESCRIPTIONS

PIN	NAME	DESCRIPTION
A1	Earpiece1_Input	Earpiece Input 1 (from audio circuitry)
A3	Earpiece2_Input	Earpiece Input 2 (from audio circuitry)
A5	Microphone_Input	Microphone Input (from microphone)
B2	GND	Device Ground
B4	GND	Device Ground
C1	Earpiece1_Output	Earpiece Output 1 (to earpiece)
C3	Earpiece2_Output	Earpiece Output 2 (to earpiece)
C5	Microphone_Output	Microphone Output (to audio circuitry)

Ordering Information

PART NUMBERING INFORMATION

Bumps	Package	Ordering Part Number ¹	Part Marking
8	CSP	CSPEMI205	AF

Note 1: Parts are shipped in Tape & Reel form unless otherwise specified.



Specifications

ABSOLUTE MAXIMUM RATINGS

PARAMETER	RATING	UNITS
Storage Temperature Range	-65 to +150	°C
DC Power per Resistor	100	mW
DC Package Power Rating	300	mW

STANDARD OPERATING CONDITIONS

PARAMETER	RATING	UNITS
Operating Temperature Range	-40 to +85	°C

ELECTRICAL OPERATING CHARACTERISTICS¹

SYMBOL	PARAMETER	CONDITIONS	MIN	TYP	MAX	UNITS
TOL _R	Resistance Tolerance				±10	%
TOL _C	Capacitance Tolerance				±20	%
I _{LEAK}	Diode Leakage Current	V _{IN} =5.0V			1.0	µA
V _{SIG}	Signal Voltage Positive Clamp Negative Clamp	I _{LOAD} = 10mA	5 -5	7 -10	15 -15	V V
V _{ESD}	In-system ESD Withstand Voltage a) Human Body Model, MIL-STD-883, Method 3015 b) Contact Discharge per IEC 61000-4-2 Level 4	Notes 2,4 and 5	±15 ±8			kV kV
V _{CL}	Clamping Voltage during ESD Discharge MIL-STD-883 (Method 3015), 8kV Positive Transients Negative Transients	Notes 2,3,4 and 5		+15 -19		V V

Note 1: T_A=25°C unless otherwise specified.

Note 2: ESD applied to input and output pins with respect to GND, one at a time.

Note 3: Clamping voltage is measured at the opposite side of the EMI filter to the ESD pin. For example, if ESD is applied to Pin A1, then clamping voltage is measured at Pin C1.

Note 4: Unused pins are left open

Note 5: The parameters are guaranteed by design.

Performance Information

Typical Filter Performance (nominal conditions unless specified otherwise, 50 Ohm Environment)

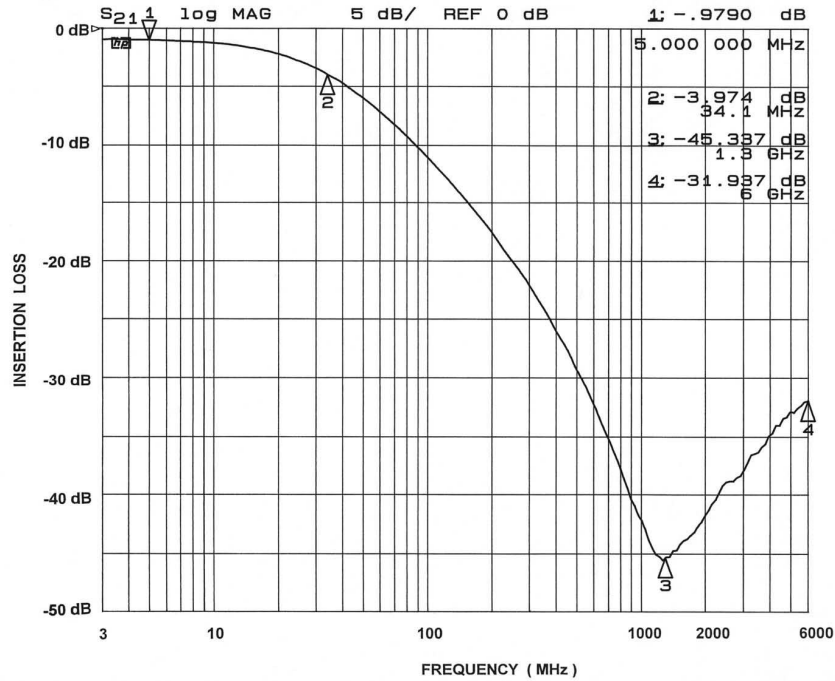

Figure 1. Earpiece Circuit (A1-C1) EMI Filter Performance

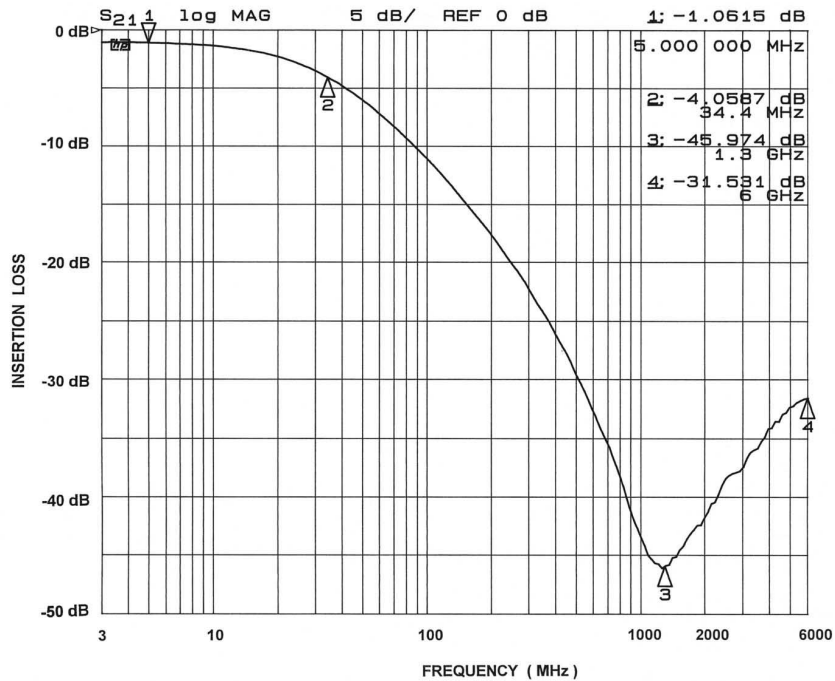

Figure 2. Earpiece Circuit (A3-C3) EMI Filter Performance

Performance Information (cont'd)

Typical Filter Performance (nominal conditions unless specified otherwise, 50 Ohm Environment)

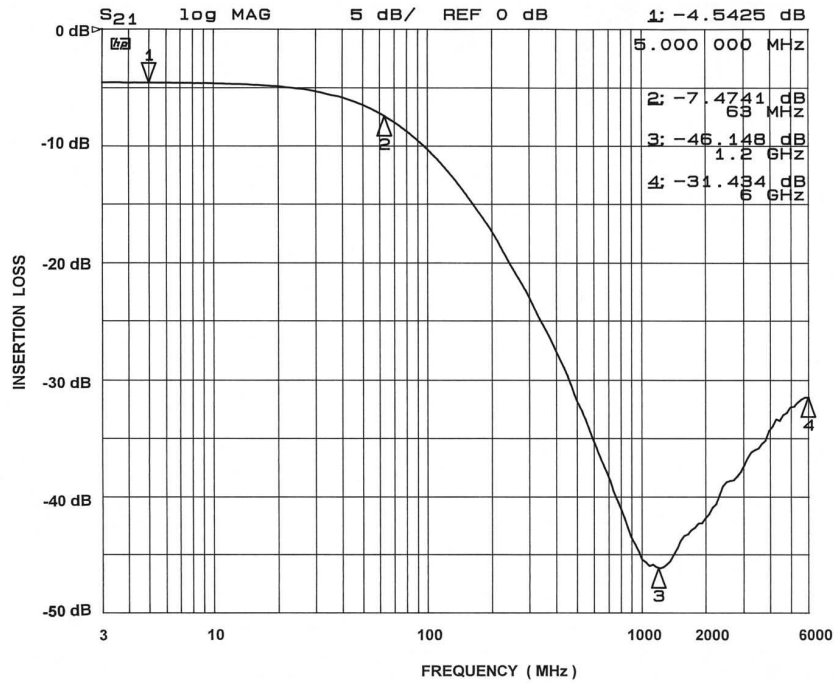

Figure 3. Microphone Circuit (A5-C5) EMI Filter Performance

Application Information

Refer to Application Note AP-217, "The Chip Scale Package", for a detailed description of Chip Scale Packages offered by California Micro Devices.

PRINTED CIRCUIT BOARD RECOMMENDATIONS	
PARAMETER	VALUE
Pad Size on PCB	0.275mm Round
Pad Definition	Non-Solder Mask defined pads
Solder Mask Opening	0.325mm Round
Solder Stencil Thickness	0.152mm
Solder Stencil Aperture Opening (laser cut, 5% tapered walls)	0.330mm Round
Solder Flux Ratio	50/50 by volume
Solder Paste Type	No Clean
Pad Protective Finish	OSP (Entek Cu Plus 106A)
Tolerance — Edge To Corner Ball	±50µm
Solder Ball Side Coplanarity	±20µm
Maximum Dwell Time Above Liquidous (183°C)	60 seconds
Soldering Maximum Temperature	240°C

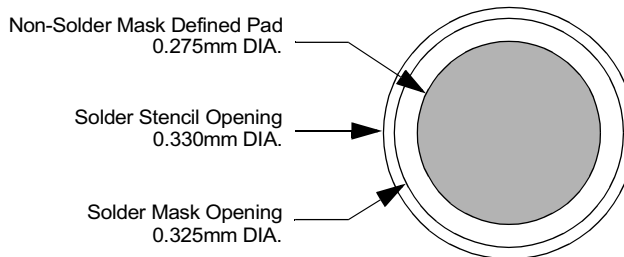

Figure 4. Recommended Non-Solder Mask Defined Pad Illustration

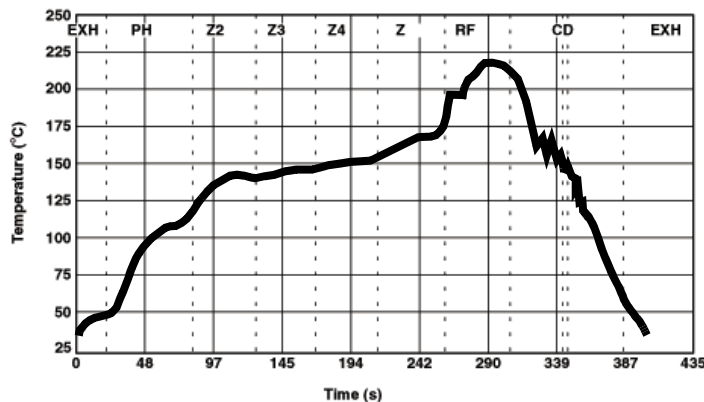

Figure 5. Solder Reflow Profile

Mechanical Details

CSP Mechanical Specifications

CSPEMI205 devices are packaged in a custom Chip Scale Package (CSP). Dimensions are presented below. For complete information on CSP packaging, see the California Micro Devices CSP Package Information document.

PACKAGE DIMENSIONS						
Package	Custom CSP					
Bumps	8					
Dim	Millimeters			Inches		
	Min	Nom	Max	Min	Nom	Max
A1	1.405	1.450	1.495	0.0553	0.0571	0.0589
A2	1.365	1.410	1.455	0.0537	0.0555	0.0573
B1	0.495	0.500	0.505	0.0195	0.0197	0.0199
B2	0.245	0.250	0.255	0.0096	0.0098	0.0100
B3	0.430	0.435	0.440	0.0169	0.0171	0.0173
B4	0.430	0.435	0.440	0.0169	0.0171	0.0173
C1	0.175	0.225	0.275	0.0069	0.0089	0.0108
C2	0.220	0.270	0.320	0.0087	0.0106	0.0126
D1	0.561	0.605	0.649	0.0221	0.0238	0.0255
D2	0.355	0.380	0.405	0.0140	0.0150	0.0159
# per tape and reel	3500 pieces					
Controlling dimension: millimeters						

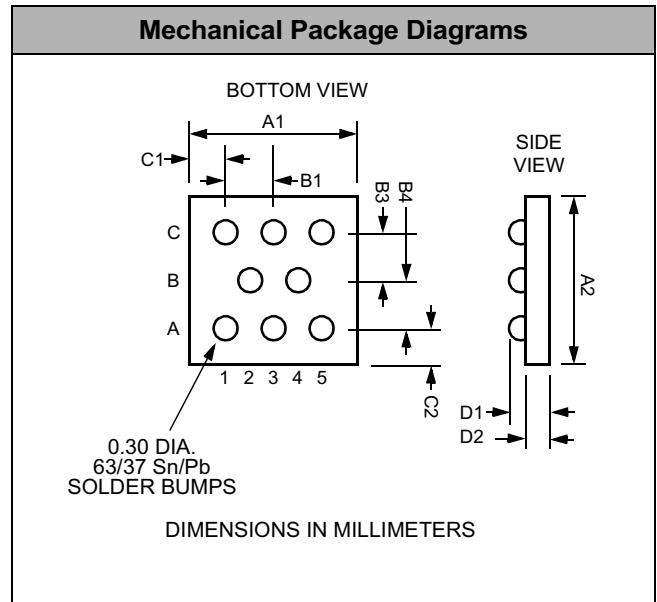

Package Dimensions for CSPEMI205 Chip Scale Package

CSP Tape and Reel Specifications

PART NUMBER	CHIP SIZE (mm)	POCKET SIZE (mm) B ₀ X A ₀ X K ₀	TAPE WIDTH W	REEL DIAMETER	QTY PER REEL	P ₀	P ₁
CSPEMI205	1.45 X 1.41 X 0.6	1.52 X 1.56 X 0.71	8mm	178mm (7")	3500	4mm	4mm

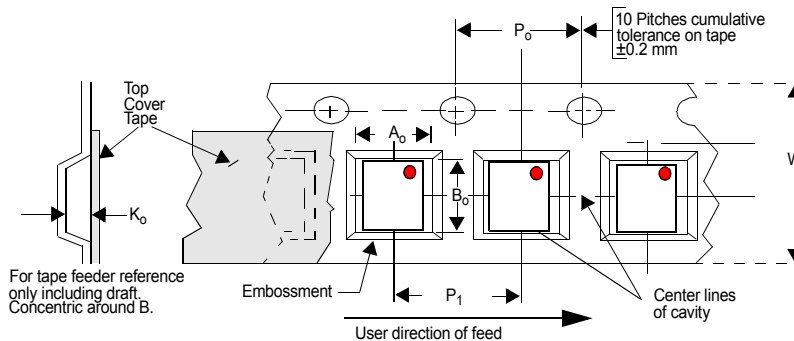

Figure 6. Tape and Reel Mechanical Data