

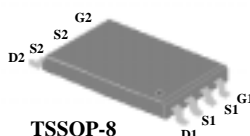

- ▼ Low on-resistance
- ▼ Capable of 2.5V gate drive
- ▼ Optimal DC/DC battery application



BV_{DSS}	20V
$R_{DS(ON)}$	23m Ω
I_D	5A

Description

The Advanced Power MOSFETs from APEC provide the designer with the best combination of fast switching, ruggedized device design, ultra low on-resistance and cost-effectiveness.

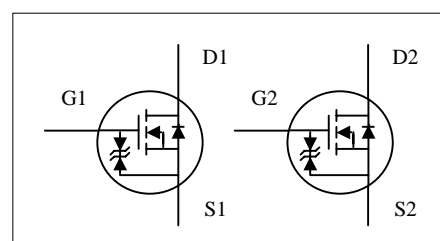

Absolute Maximum Ratings

Symbol	Parameter	Rating	Units
V_{DS}	Drain-Source Voltage	20	V
V_{GS}	Gate-Source Voltage	± 12	V
$I_D @ T_A = 25^\circ C$	Drain Current ³ , V_{GS} @ 4.5V	5	A
$I_D @ T_A = 70^\circ C$	Drain Current ³ , V_{GS} @ 4.5V	3.5	A
I_{DM}	Pulsed Drain Current ¹	25	A
$P_D @ T_A = 25^\circ C$	Total Power Dissipation	1	W
	Linear Derating Factor	0.008	W/ $^\circ C$
T_{STG}	Storage Temperature Range	-55 to 150	$^\circ C$
T_J	Operating Junction Temperature Range	-55 to 150	$^\circ C$

Thermal Data

Symbol	Parameter	Value	Unit
Rthj-a	Thermal Resistance Junction-ambient ³	Max. 125	$^\circ C/W$

Electrical Characteristics @ $T_j=25^\circ\text{C}$ (unless otherwise specified)

Symbol	Parameter	Test Conditions	Min.	Typ.	Max.	Units
BV_{DSS}	Drain-Source Breakdown Voltage	$V_{GS}=0V, I_D=250\mu A$	20	-	-	V
$\Delta BV_{DSS}/\Delta T_j$	Breakdown Voltage Temperature Coefficient	Reference to 25°C , $I_D=1\text{mA}$	-	0.02	-	$V/^\circ\text{C}$
$R_{DS(ON)}$	Static Drain-Source On-Resistance ²	$V_{GS}=4.5V, I_D=5A$	-	-	23	$\text{m}\Omega$
		$V_{GS}=2.5V, I_D=2A$	-	-	29	$\text{m}\Omega$
$V_{GS(th)}$	Gate Threshold Voltage	$V_{DS}=V_{GS}, I_D=250\mu A$	0.5	-	-	V
g_{fs}	Forward Transconductance	$V_{DS}=10V, I_D=5A$	-	21	-	S
I_{DSS}	Drain-Source Leakage Current ($T_j=25^\circ\text{C}$)	$V_{DS}=20V, V_{GS}=0V$	-	-	1	μA
	Drain-Source Leakage Current ($T_j=70^\circ\text{C}$)	$V_{DS}=20V, V_{GS}=0V$	-	-	25	μA
I_{GSS}	Gate-Source Leakage	$V_{GS}=\pm 12V$	-	-	± 10	μA
Q_g	Total Gate Charge ²	$I_D=5A$	-	15.9	-	nC
Q_{gs}	Gate-Source Charge	$V_{DS}=10V$	-	1.5	-	nC
Q_{gd}	Gate-Drain ("Miller") Charge	$V_{GS}=4.5V$	-	7.4	-	nC
$t_{d(on)}$	Turn-on Delay Time ²	$V_{DS}=10V$	-	6.2	-	ns
t_r	Rise Time	$I_D=1A$	-	9	-	ns
$t_{d(off)}$	Turn-off Delay Time	$R_G=3.3\Omega, V_{GS}=4.5V$	-	30	-	ns
t_f	Fall Time	$R_D=10\Omega$	-	11	-	ns
C_{iss}	Input Capacitance	$V_{GS}=0V$	-	530	-	pF
C_{oss}	Output Capacitance	$V_{DS}=20V$	-	245	-	pF
C_{rss}	Reverse Transfer Capacitance	$f=1.0\text{MHz}$	-	125	-	pF

Source-Drain Diode

Symbol	Parameter	Test Conditions	Min.	Typ.	Max.	Units
I_S	Continuous Source Current (Body Diode)	$V_D=V_G=0V, V_S=1.2V$	-	-	0.83	A
V_{SD}	Forward On Voltage ²	$T_j=25^\circ\text{C}, I_S=5A, V_{GS}=0V$	-	-	1.2	V

Notes:

- 1.Pulse width limited by Max. junction temperature.
- 2.Pulse width $\leq 300\mu s$, duty cycle $\leq 2\%$.
- 3.Surface mounted on 1 in^2 copper pad of FR4 board ; $208^\circ\text{C}/W$ when mounted on Min. copper pad.

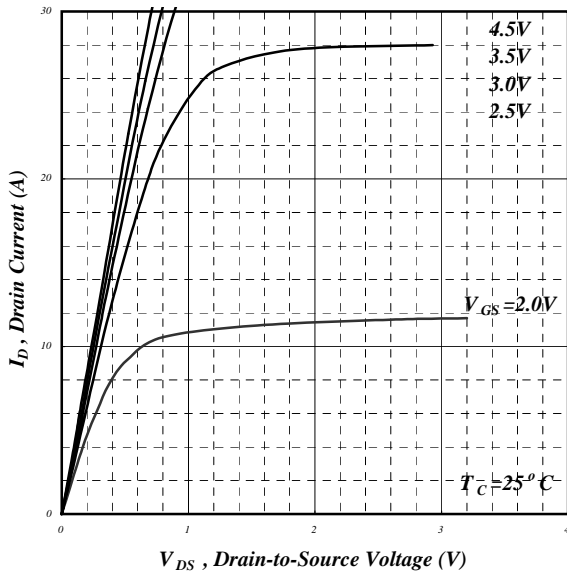

Fig 1. Typical Output Characteristics

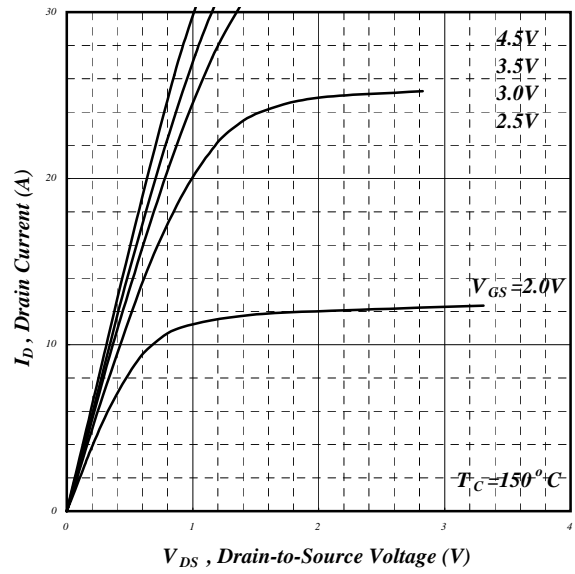

Fig 2. Typical Output Characteristics

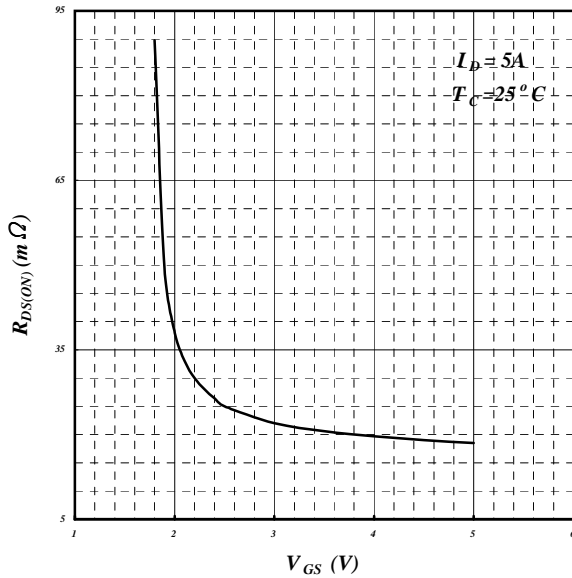

Fig 3. On-Resistance v.s. Gate Voltage

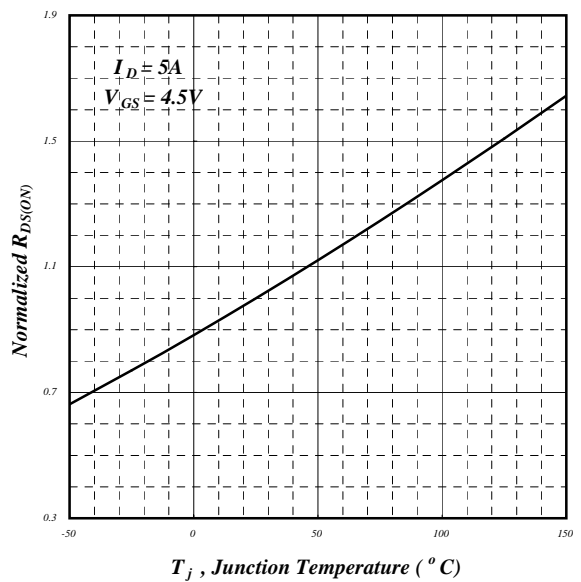

Fig 4. Normalized On-Resistance v.s. Junction Temperature

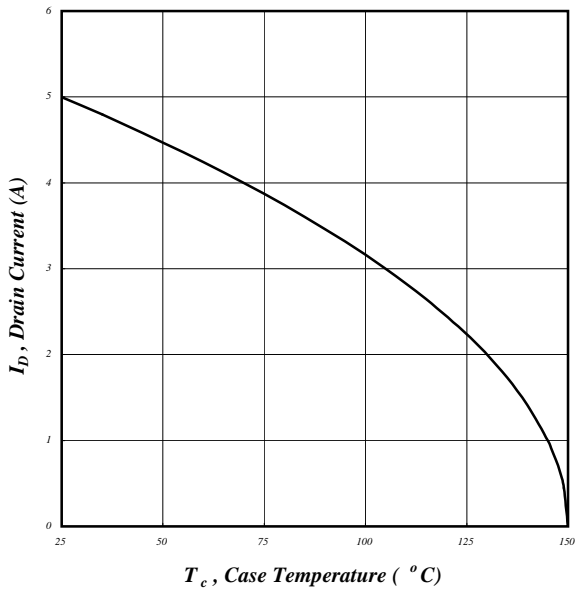

Fig 5. Maximum Drain Current v.s. Case Temperature

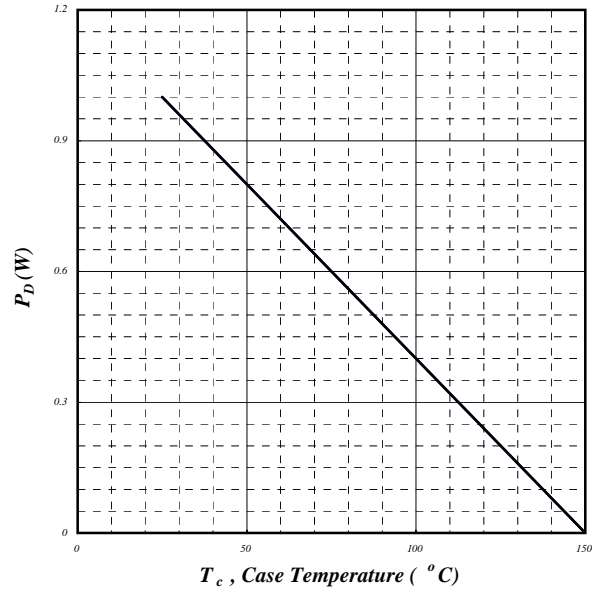

Fig 6. Typical Power Dissipation

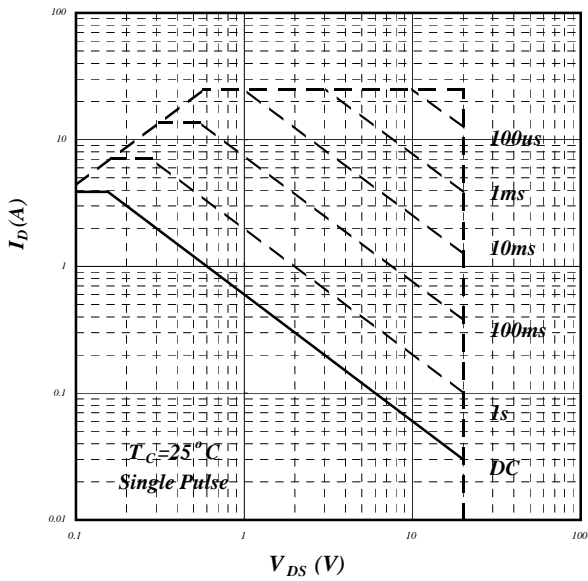

Fig 7. Maximum Safe Operating Area

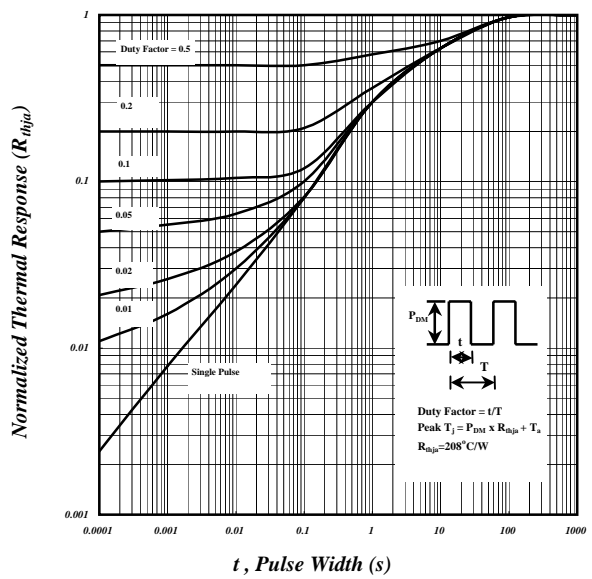

Fig 8. Effective Transient Thermal Impedance

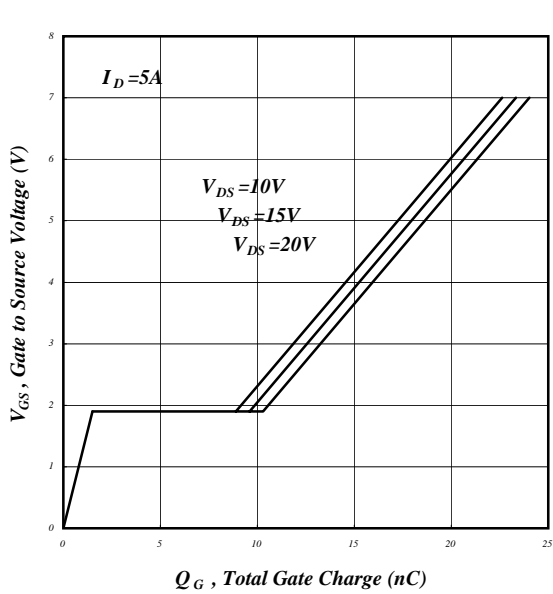

Fig 9. Gate Charge Characteristics

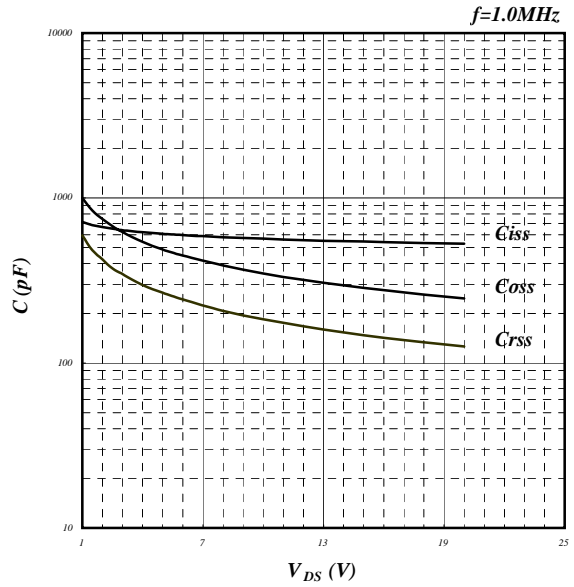

Fig 10. Typical Capacitance Characteristics

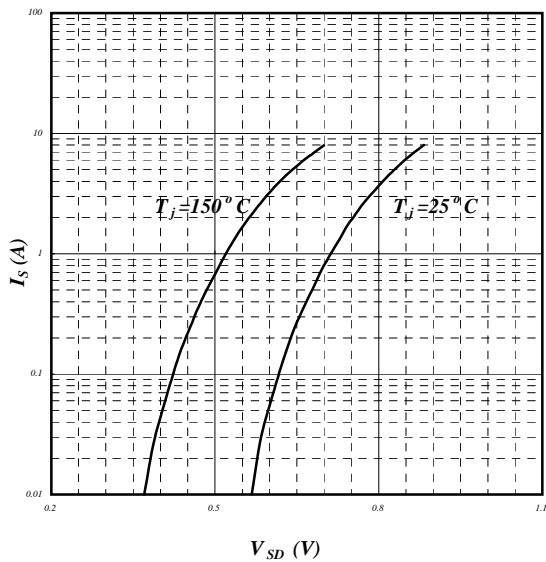

Fig 11. Forward Characteristic of Reverse Diode

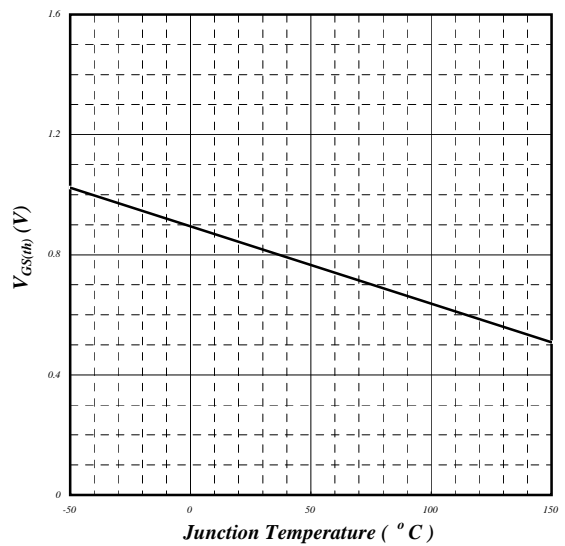

Fig 12. Gate Threshold Voltage v.s. Junction Temperature

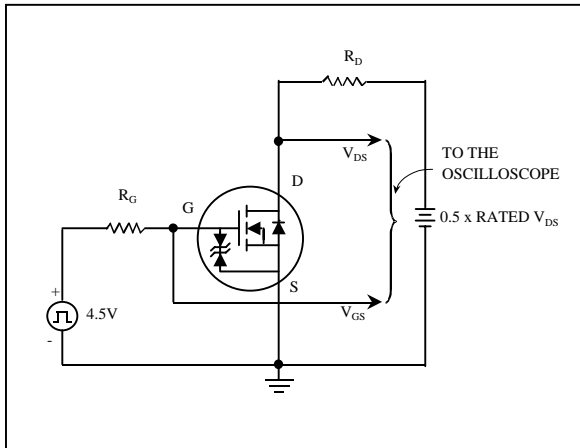

Fig 13. Switching Time Circuit

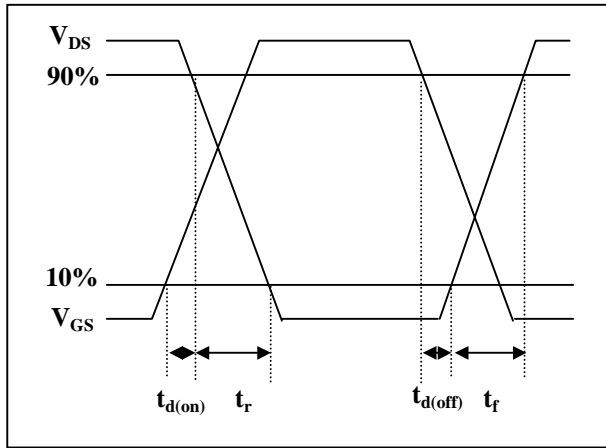

Fig 14. Switching Time Waveform

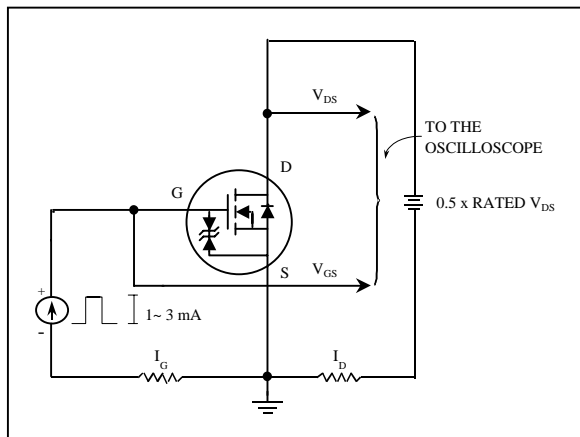

Fig 15. Gate Charge Circuit

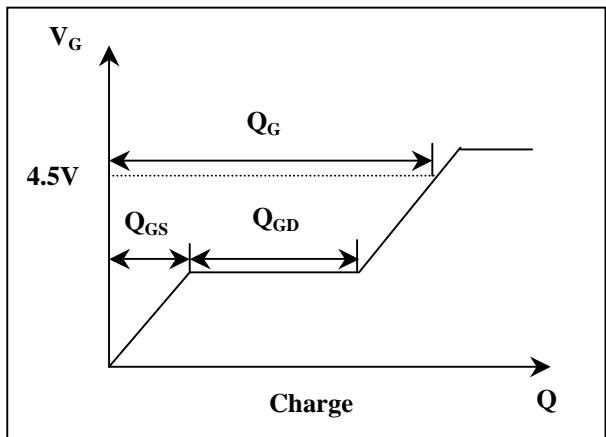

Fig 16. Gate Charge Waveform