

# AN7395K, AN7395S

## Spatializer IC (3-D Surround)

### Overview

Spatializer Audio Processor is a signal processing technology, monopolized by Desper Products, Inc., that was developed for commercial electronics and multimedia markets, and is based on Desper's "PRO Spatializer" that is a 3-D audio production system for business use. The AN7395K, AN7395S utilizes the innovative technology adopted in that system, and provides sound enhancement effect and sound expansion with the conventional 2-speaker stereo system.

### Features

- Provides deep 3-D sound with conventional 2-speaker system.
- The audio signal recorded through this IC can be reproduced with usual stereo system.
- Performs optimal processing to the sound source recorded with surround-effect so as not to give double effects.
- Sound expansion effect can be varied.
- A pseudo stereo effect for the monaural audio signal is achieved.
- Positions and moves each sound source on 270° arc in real time.

### Applications

- Televisions, videos, audio equipment, personal computers, and game machines

### Pin Assignment

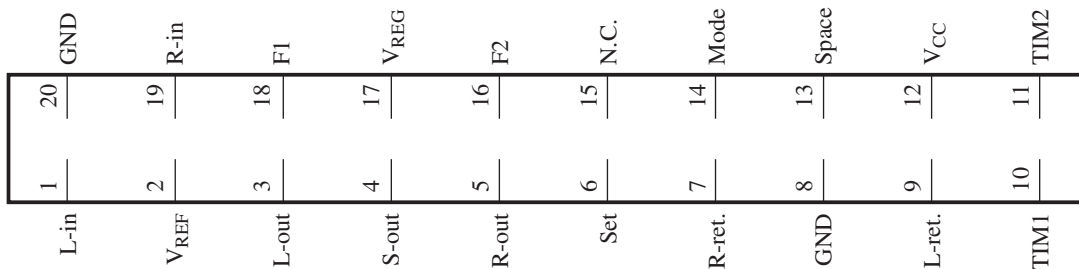

Note) Spatializer® and the device trademark of circle-in-square are owned by Desper Products Inc.

This product can be used with the consent of the Desper Products Inc.

Under the terms of the agreement between Matsushita Electric and Desper Products Inc., no technical information on the Spatializer, which is applied to this product, shall be provided.

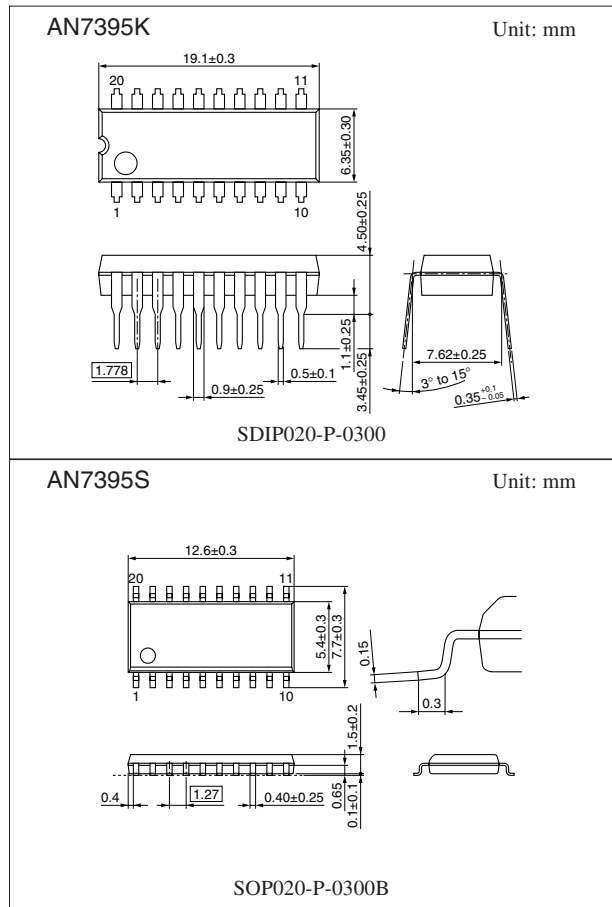

Note) The packages (SDIP020-P-0300 and SOP020-P-0300B) of this product will be changed to lead-free type (SDIP020-P-0300A and SOP020-P-0300E). See the new package dimensions section later of this datasheet.

### ■ Pin Descriptions

Pin No.	Descriptions	Pin No.	Descriptions
1	L-in	11	TIM2
2	V <sub>REF</sub>	12	V <sub>CC</sub>
3	L-out	13	Space
4	S-out	14	Mode
5	R-out	15	N.C.
6	Set	16	F2
7	R-ret.	17	V <sub>REG</sub>
8	GND	18	F1
9	L-ret.	19	R-in
10	TIM1	20	GND

### ■ Absolute Maximum Ratings

Parameter	Symbol	Rating	Unit
Supply voltage	V <sub>CC</sub>	11	V
Supply current	I <sub>CC</sub>	100	mA
Power dissipation *2	P <sub>D</sub>	230	mW
Operating ambient temperature *1	T <sub>opr</sub>	-25 to +75	°C
Storage temperature *1	T <sub>stg</sub>	-55 to +125	°C

Note) \*1: Except for the operating ambient temperature and storage temperature, all ratings are for T<sub>a</sub> = 25°C.

\*2: The power dissipation shown is the value for T<sub>a</sub> = 75°C

### ■ Recommended Operating Range

Parameter	Symbol	Range	Unit
Supply voltage	V <sub>CC</sub>	6.0 to 10.0	V

■ Electrical Characteristics at  $V_{CC} = 9\text{ V}$ ,  $f = 1\text{ kHz}$ ,  $T_a = 25^\circ\text{C} \pm 2^\circ\text{C}$

Parameter	Symbol	Conditions	Min	Typ	Max	Unit
Total circuit current	$I_{TOTAL}$	$V_{IN} = 0\text{ mV}$	5	11	17	mA
Maximum output voltage *3	$V_{OUT1}$	L-in, R-in THD = 1%	2.0	2.8	—	V[rms]
Output noise voltage 1 *1,4	$V_{NO1}$	L-out, R-out $R_G = 4.7\text{ k}\Omega$	—	20	100	$\mu\text{V}$ [rms]
Voltage gain 1 *3	$G_{V1}$	L-out, R-out $V_{IN} = 400\text{ mV}$	-2	0	2	dB
Total harmonic distortion 1 *2,3	THD <sub>1</sub>	L-out, R-out $V_{IN} = 400\text{ mV}$	—	0.05	0.3	%
Output noise voltage 2 *1,5	$V_{NO2}$	S-out $R_G = 4.7\text{ k}\Omega$	—	160	600	$\mu\text{V}$ [rms]
Voltage gain 2 *6	$G_{V2}$	S-out $V_{IN} = 60\text{ mV}$	200	280	400	mV[rms]
Total harmonic distortion 2 *2,6	THD <sub>2</sub>	S-out $V_{IN} = 60\text{ mV}$	—	0.05	0.3	%
Mono mode switching voltage	$V_M$		4.2	—	$V_{CC}$	V
Off mode switching voltage	$V_{OFF}$		0	—	0.9	V
Stereo mode switching voltage	$V_{ST}$		2.1	—	2.8	V

Note) \*1: In measuring, the filter with A-characteristic curve is used.

\*2: In measuring, the filter for the range of 15 Hz to 30 kHz (12 dB/OCT) is used.

\*3: Mode: ST, L-in + R-in, VCA min.

\*4: Mode: ST, VCA min.

\*5: Mode: ST, VCA max.

\*6: Mode: ST, VCA max. for either L-in or R-in.

■ Conceptual Explanation of Spatializer Operation

• Normal stereo

All sounds are heard from only between two speakers, right and left.



• Conventional surround

The sound expands toward the outside of the speaker system, but the sound position comes apart mostly in the conventional systems.

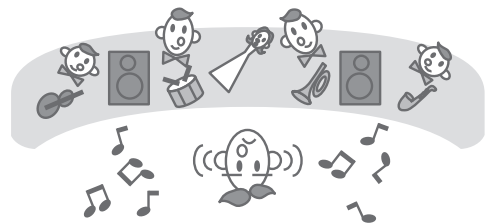

• Spatializer

The sound expands toward the outside of the two speakers, and yet their positions are stable and an expanded, deep sound are gotten.

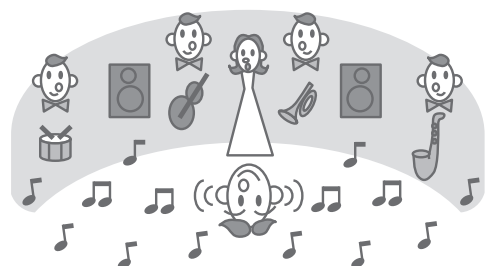

■ Application Circuit Example (Basic circuitry)

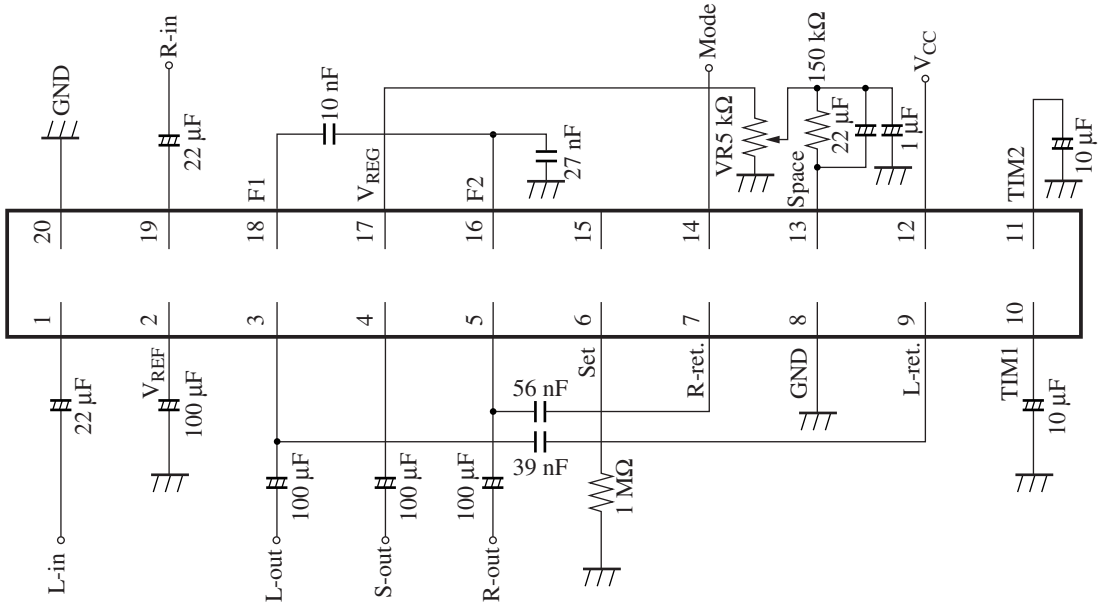

Note) When switching noise occurs at mode switching, insert a capacitor between pin 14 and GND.

■ New Package Dimensions (Unit: mm)

- SDIP020-P-0300A (Lead-free package)

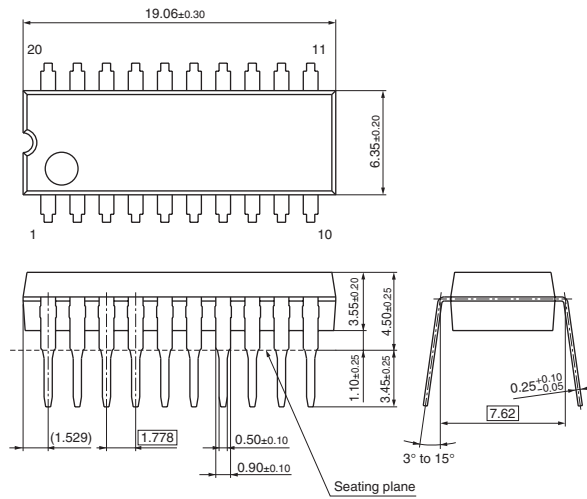

- SOP020-P-0300E (Lead-free package)

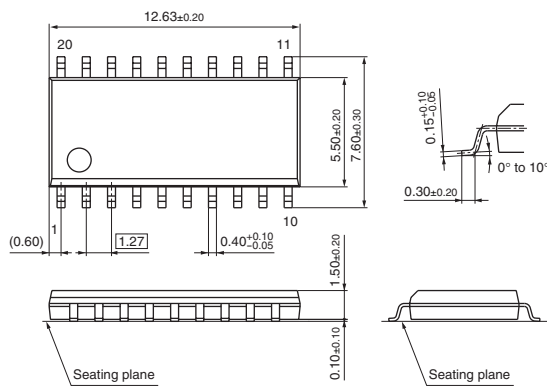

## Request for your special attention and precautions in using the technical information and semiconductors described in this material

- (1) An export permit needs to be obtained from the competent authorities of the Japanese Government if any of the products or technologies described in this material and controlled under the "Foreign Exchange and Foreign Trade Law" is to be exported or taken out of Japan.
- (2) The technical information described in this material is limited to showing representative characteristics and applied circuits examples of the products. It neither warrants non-infringement of intellectual property right or any other rights owned by our company or a third party, nor grants any license.
- (3) We are not liable for the infringement of rights owned by a third party arising out of the use of the product or technologies as described in this material.
- (4) The products described in this material are intended to be used for standard applications or general electronic equipment (such as office equipment, communications equipment, measuring instruments and household appliances).  
Consult our sales staff in advance for information on the following applications:
  - Special applications (such as for airplanes, aerospace, automobiles, traffic control equipment, combustion equipment, life support systems and safety devices) in which exceptional quality and reliability are required, or if the failure or malfunction of the products may directly jeopardize life or harm the human body.
  - Any applications other than the standard applications intended.
- (5) The products and product specifications described in this material are subject to change without notice for modification and/or improvement. At the final stage of your design, purchasing, or use of the products, therefore, ask for the most up-to-date Product Standards in advance to make sure that the latest specifications satisfy your requirements.
- (6) When designing your equipment, comply with the guaranteed values, in particular those of maximum rating, the range of operating power supply voltage, and heat radiation characteristics. Otherwise, we will not be liable for any defect which may arise later in your equipment.  
Even when the products are used within the guaranteed values, take into the consideration of incidence of break down and failure mode, possible to occur to semiconductor products. Measures on the systems such as redundant design, arresting the spread of fire or preventing glitch are recommended in order to prevent physical injury, fire, social damages, for example, by using the products.
- (7) When using products for which damp-proof packing is required, observe the conditions (including shelf life and amount of time let standing of unsealed items) agreed upon when specification sheets are individually exchanged.
- (8) This material may be not reprinted or reproduced whether wholly or partially, without the prior written permission of Matsushita Electric Industrial Co., Ltd.