

# Low frequency amplifier

## 2SD2657

### ●Application

Low frequency amplifier  
Driver

### ●Features

- 1) A collector current is large.
- 2)  $V_{CE(sat)} \leq 350\text{mV}$   
At  $I_C = 1\text{A} / I_B = 50\text{mA}$

### ●External dimensions (Units : mm)

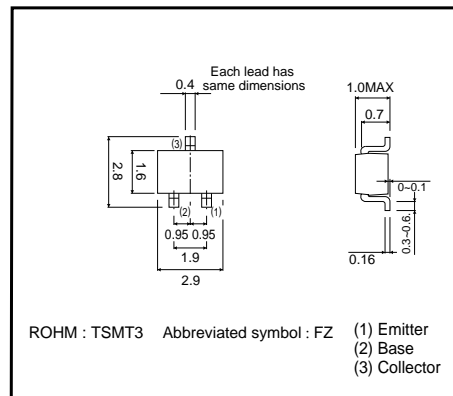

### ●Absolute maximum ratings (Ta=25°C)

Parameter	Symbol	Limits	Unit
Collector-base voltage	$V_{CB0}$	30	V
Collector-emitter voltage	$V_{CE0}$	30	V
Emitter-base voltage	$V_{EB0}$	6	V
Collector current	$I_C$	1.5	A
	$I_{CP}$	3	A *
Power dissipation	$P_C$	500	mW
Junction temperature	$T_j$	150	°C
Range of storage temperature	$T_{stg}$	-55~+150	°C

\*Single pulse,  $P_W=1\text{ms}$

### ●Packaging specifications

Type	Package	Taping
	Code	TL
	Basic ordering unit (pieces)	3000
2SD2657		○

### ●Electrical characteristics (Ta=25°C)

Parameter	Symbol	Min.	Typ.	Max.	Unit	Conditions
Collector-base breakdown voltage	$BV_{CB0}$	30	—	—	V	$I_C=10\mu\text{A}$
Collector-emitter breakdown voltage	$BV_{CE0}$	30	—	—	V	$I_C=1\text{mA}$
Emitter-base breakdown voltage	$BV_{EB0}$	6	—	—	V	$I_E=10\mu\text{A}$
Collector cutoff current	$I_{CBO}$	—	—	100	nA	$V_{CB}=30\text{V}$
Emitter cutoff current	$I_{EBO}$	—	—	100	nA	$V_{EB}=6\text{V}$
Collector-emitter saturation voltage	$V_{CE(sat)}$	—	140	350	mV	$I_C=1\text{A}, I_B=50\text{mA}$
DC current gain	$h_{FE}$	270	—	680	—	$V_{CE}=2\text{V}, I_C=100\text{mA}^*$
Transition frequency	$f_T$	—	300	—	MHz	$V_{CE}=2\text{V}, I_E=-100\text{mA}, f=100\text{MHz}^*$
Corrector output capacitance	$C_{ob}$	—	11	—	pF	$V_{CB}=10\text{V}, I_E=0\text{A}, f=1\text{MHz}$

\* Pulsed

Transistors

●Electrical characteristic curves

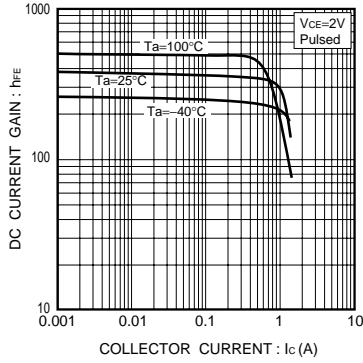

Fig.1 DC current gain vs. collector current

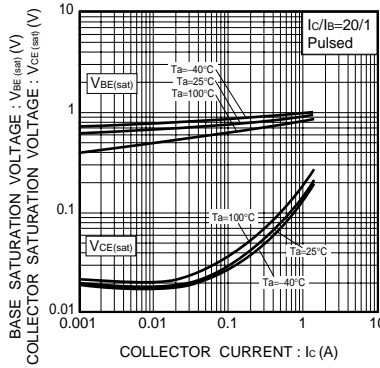

Fig.2 Collector-emitter saturation voltage base-emitter saturation voltage vs. collector current

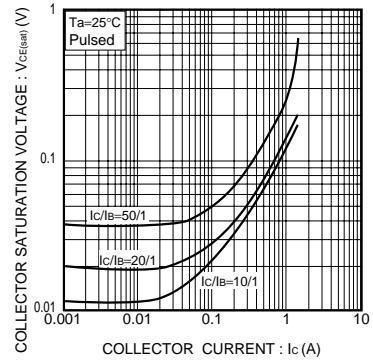

Fig.3 Collector-emitter saturation voltage vs. collector current

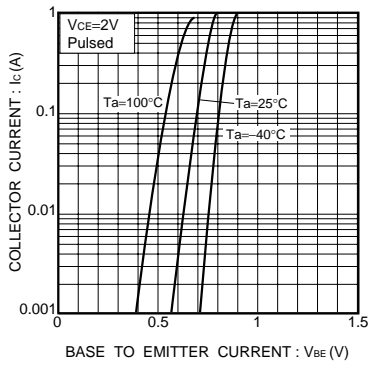

Fig.4 Grounded emitter propagation characteristics

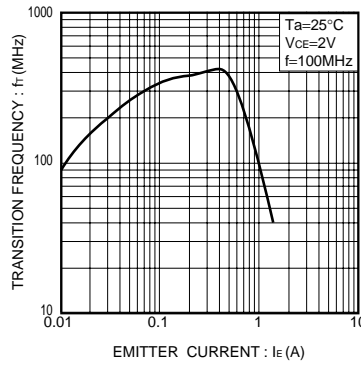

Fig.5 Gain bandwidth product vs. emitter current

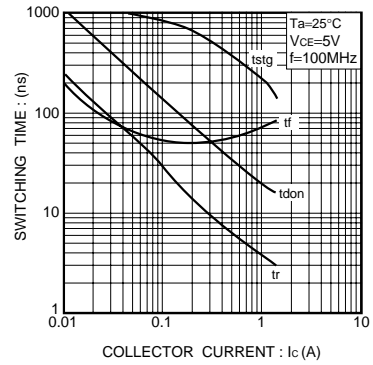

Fig.6 Switching time

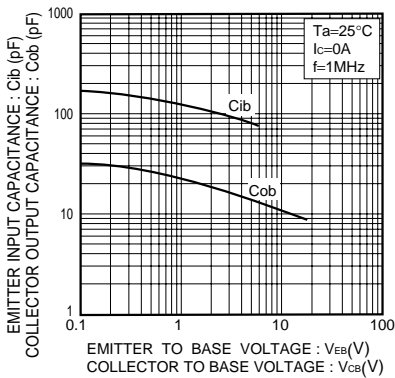

Fig.7 Collector output capacitance vs. collector-base voltage  
Emitter input capacitance vs. emitter-base voltage