

### Circuit Diagram

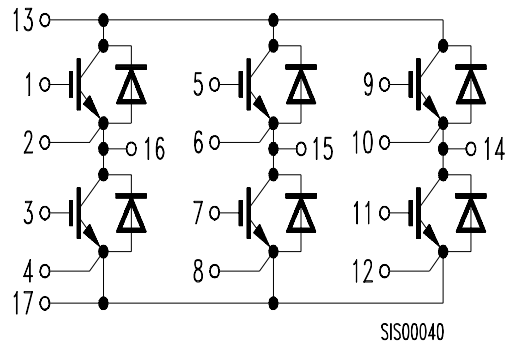

### Package Outlines

Dimensions in mm

Weight: 180 g

