

Small switching (30V, 0.1A)

UM5K1N

●Features

- 1) Two 2SK3018 transistors in a single UMT package.
- 2) Mounting cost and area can be cut in half.
- 3) Low on-resistance.
- 4) Low voltage drive (2.5V) makes this device ideal for portable equipment.
- 5) Easily designed drive circuits.

●Applications

Interfacing, switching (30V, 100mA)

●Structure

Silicon N-channel
MOSFET

●External dimensions (Units: mm)

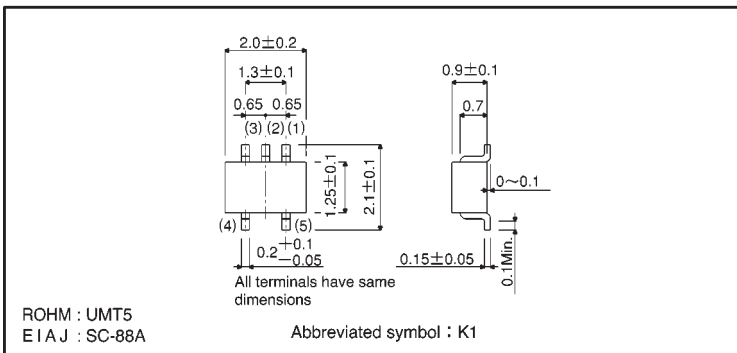

●Equivalent circuit

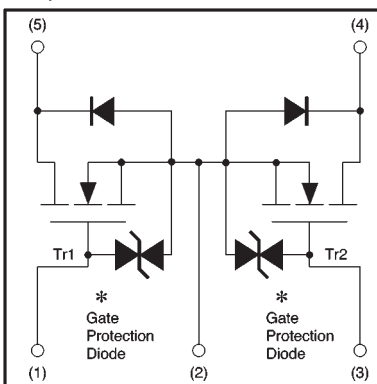

●Absolute maximum ratings (Ta = 25°C)

Parameter	Symbol	Limits	Unit
Drain-source voltage	V _{DSS}	30	V
Gate-source voltage	V _{GSS}	±20	V
Drain current	Continuous	I _D	100 mA
	Pulsed	I _{DP} *1	200 mA
Reverse drain current	Continuous	I _{DR}	100 mA
	Pulsed	I _{DRP} *1	200 mA
Total power dissipation (Tc=25°C)	P _D *2	150	mW
Channel temperature	T _{ch}	150	°C
Storage temperature	T _{stg}	-55~+150	°C

*1 P_w ≤ 10 μs, Duty cycle ≤ 50%

*2 With each pin mounted on the recommended lands.

●Packaging specifications

Type	Package	Taping
	Code	TR
	Basic ordering unit (pieces)	3000
UM5K1N		○

●Electrical characteristics (Ta = 25°C)

Parameter	Symbol	Min.	Typ.	Max.	Unit	Test Conditions
Gate-source leakage	I_{GSS}	—	—	± 1	μA	$V_{GS} = \pm 20V, V_{DS} = 0V$
Drain-source breakdown voltage	$V_{(BR)DSS}$	30	—	—	V	$I_D = 10 \mu A, V_{GS} = 0V$
Zero gate voltage drain current	I_{DSS}	—	—	1.0	μA	$V_{DS} = 30V, V_{GS} = 0V$
Gate threshold voltage	$V_{GS(th)}$	0.8	—	1.5	V	$V_{DS} = 3V, I_D = 100 \mu A$
Static drain-source on-stage resistance	$R_{DS(on)}$	—	5	8	Ω	$I_D = 10mA, V_{GS} = 4V$
	$R_{DS(on)}$	—	7	13	Ω	$I_D = 1mA, V_{GS} = 2.5V$
Forward transfer admittance	$ Y_{fs} $	20	—	—	mS	$I_D = 10mA, V_{DS} = 3V$
Input capacitance	C_{iss}	—	13	—	pF	$V_{DS} = 5V$
Output capacitance	C_{oss}	—	9	—	pF	$V_{GS} = 0V$
Reverse transfer capacitance	C_{rss}	—	4	—	pF	$f = 1MHz$
Turn-on delay time	$t_{d(on)}$	—	15	—	ns	$I_D = 10mA, V_{DD} = 5V$
Rise time	t_r	—	35	—	ns	$V_{GS} = 5V$
Turn-off delay time	$t_{d(off)}$	—	80	—	ns	$R_L = 500 \Omega$
Fall time	t_f	—	80	—	ns	$R_{GS} = 10 \Omega$

●Electrical characteristic curves

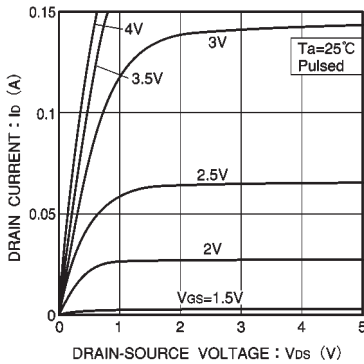

Fig.1 Typical output characteristics

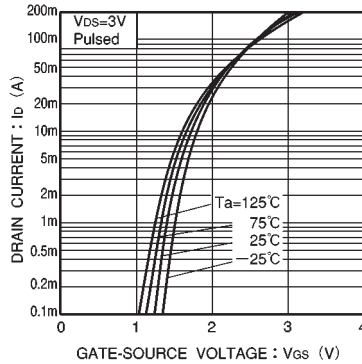

Fig.2 Typical transfer characteristics

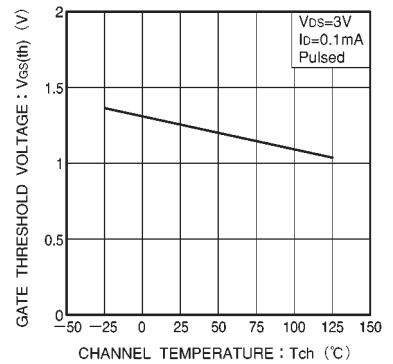

Fig.3 Gate threshold voltage vs. channel temperature

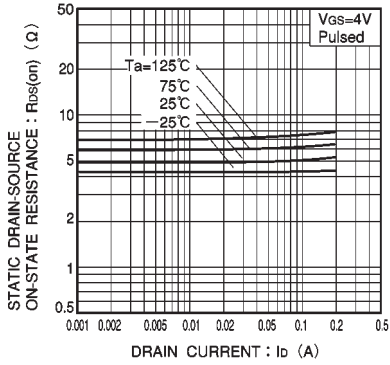

Fig.4 Static drain-source on-state resistance vs. drain current (I)

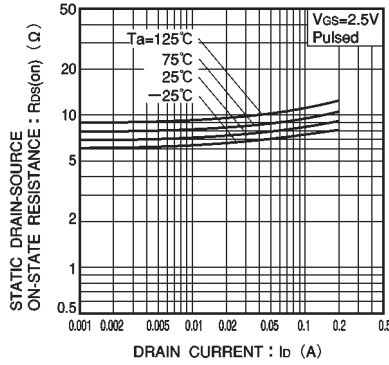

Fig.5 Static drain-source on-state resistance vs. drain current (II)

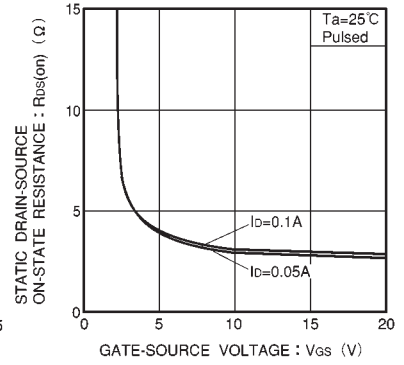

Fig.6 Static drain-source on-state resistance vs. gate-source voltage

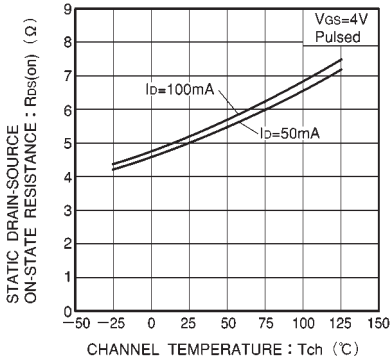

Fig.7 Static drain-source on-state resistance vs. channel temperature

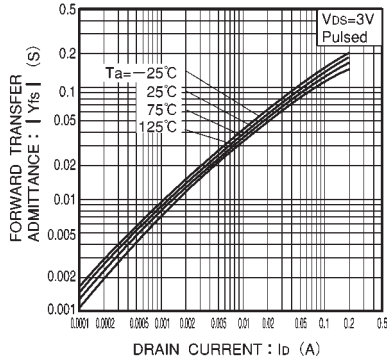

Fig.8 Forward transfer admittance vs. drain current

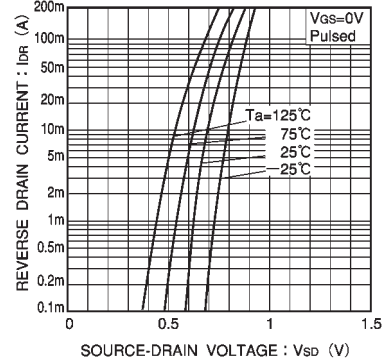

Fig.9 Reverse drain current vs. source-drain voltage (I)

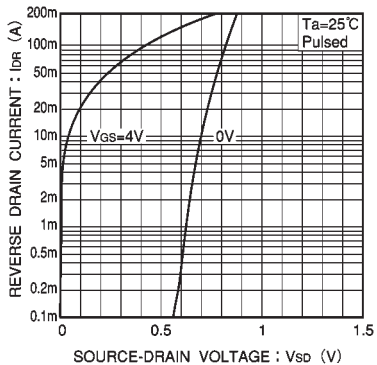

Fig.10 Reverse drain current vs. source-drain voltage (II)

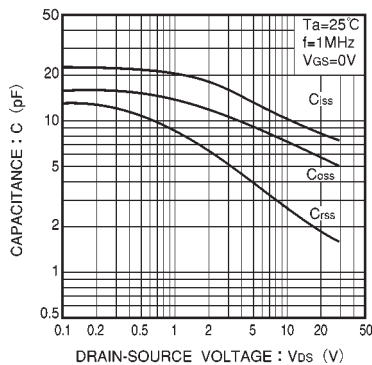

Fig.11 Typical capacitance vs. drain-source voltage

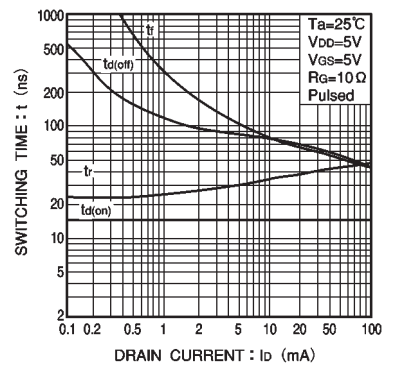

Fig.12 Switching characteristics (See Figures 13 and 14 for the measurement circuit and resultant waveforms)

● Switching characteristics measurement circuit

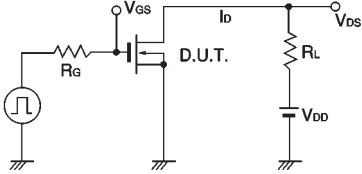

Fig.13 Switching time measurement circuit

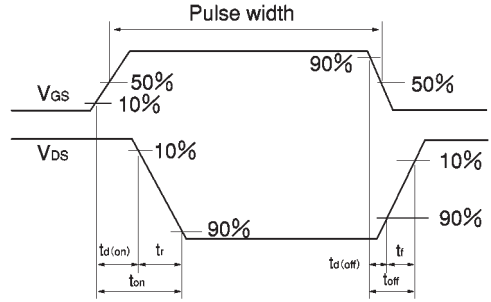

Fig.14 Switching time waveforms