

# SPECIFICATION FOR LCD MODULE

Model No. TM24064BBF

<b>Prepared by:</b>	<b>Date:</b>
<b>Checked by :</b>	<b>Date:</b>
<b>Verified by :</b>	<b>Date:</b>
<b>Approved by:</b>	<b>Date:</b>

**TIANMA MICROELECTRONICS CO., LTD**

**REVISION RECORD**

<b>Date</b>	<b>Ref. Page</b>	<b>Revision No.</b>	<b>Revision Items</b>	<b>Check &amp; Approval</b>

## 1. General Specifications:

- 1.1 Display type: STN
- 1.2 Display color\*:
  - Display color: Blue-Black
  - Background: Yellow-Green
- 1.3 Polarizer mode: Transmissive/Positive
- 1.4 Viewing Angle: 6:00
- 1.5 Driving Method: 1/64 Duty 1/9 Bias
- 1.6 Backlight: L E D
- 1.7 Controller: T6963C
- 1.8 Data Transfer: 8 Bit Parallel
- 1.9 Operating Temperature: 0 to +50 °C
  - Storage Temperature: -20 to +60 °C
- 1.10 Outline Dimensions: Refer to outline drawing on next page
- 1.11 Dot Matrix: 240 X 64 Dots
- 1.12 Dot Size: 0.49 X 0.49 (mm)
- 1.13 Dot Pitch: 0.53 X 0.53 (mm)
- 1.14 Weight: 150g

\* Color tone is slightly changed by temperature and driving voltage.

## 2. Outline Drawing

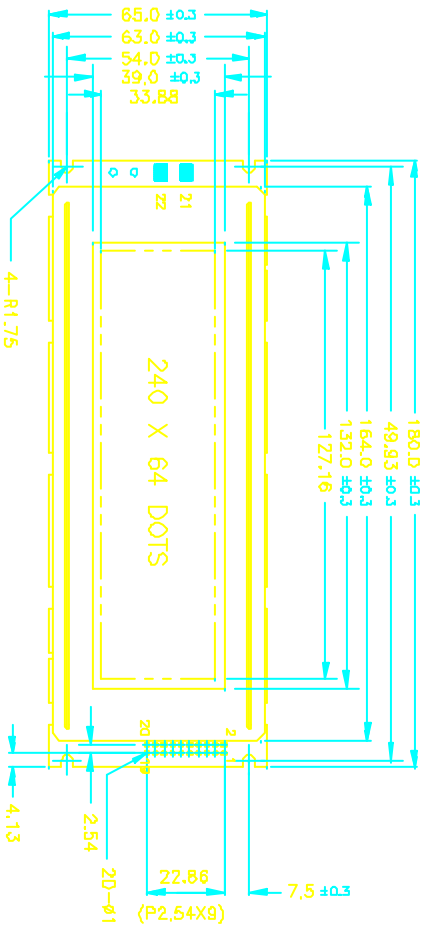

1	2	3	4	5	6	7	8	9	10	11	12	13	14	15	16	17	18	19	20	21	22
102	104	106	108	110	112	114	116	118	120	122	124	126	128	130	132	134	136	138	140	142	144

TYPE	*1	*2
RGBEL	5.4	12.0
LED	9.4	15.0

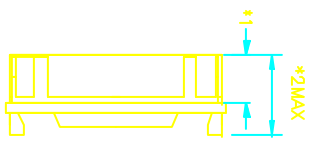
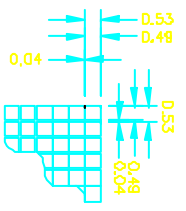

### 3. LCD Module Part Numbering System

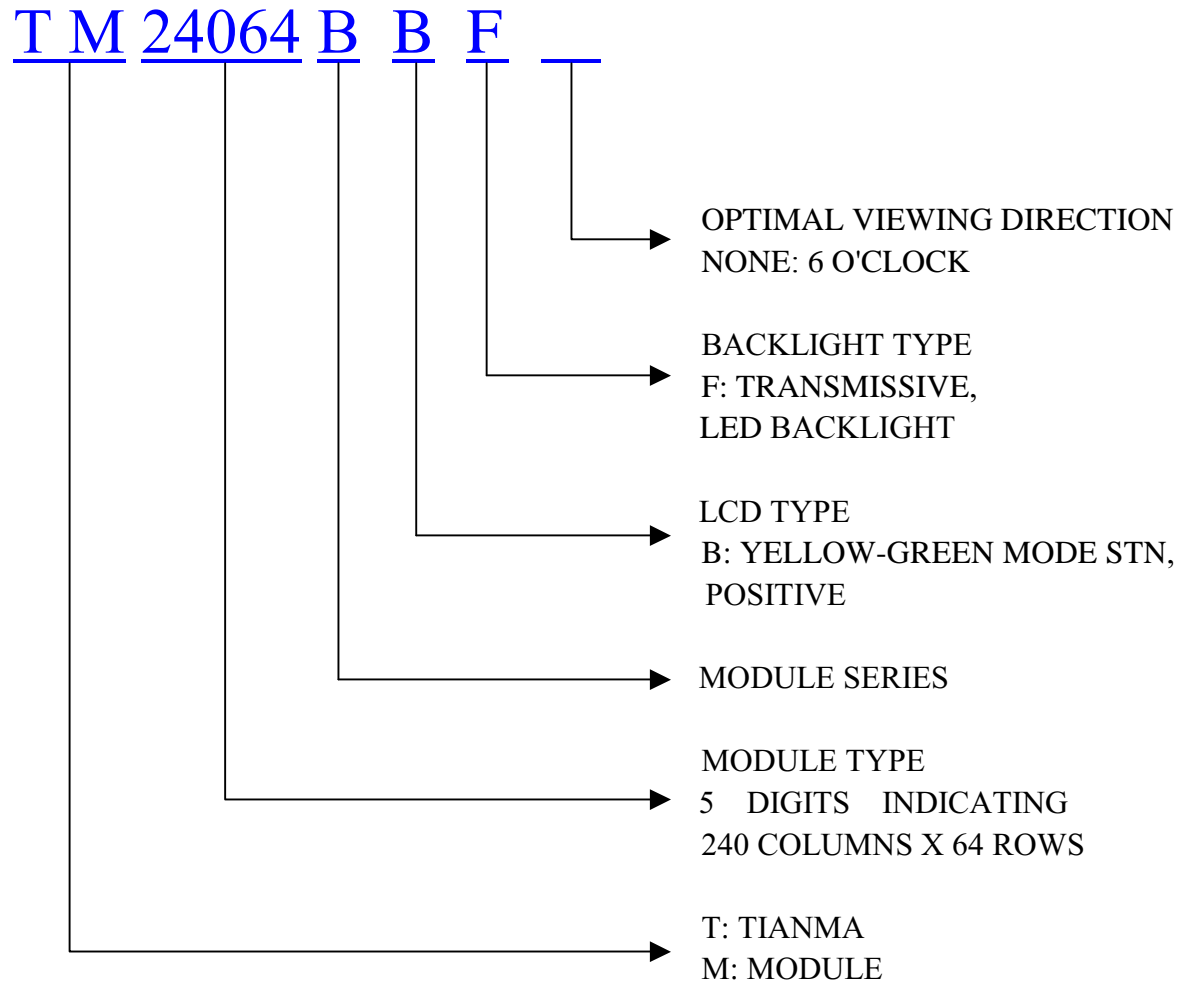

### 4. Circuit Block Diagram

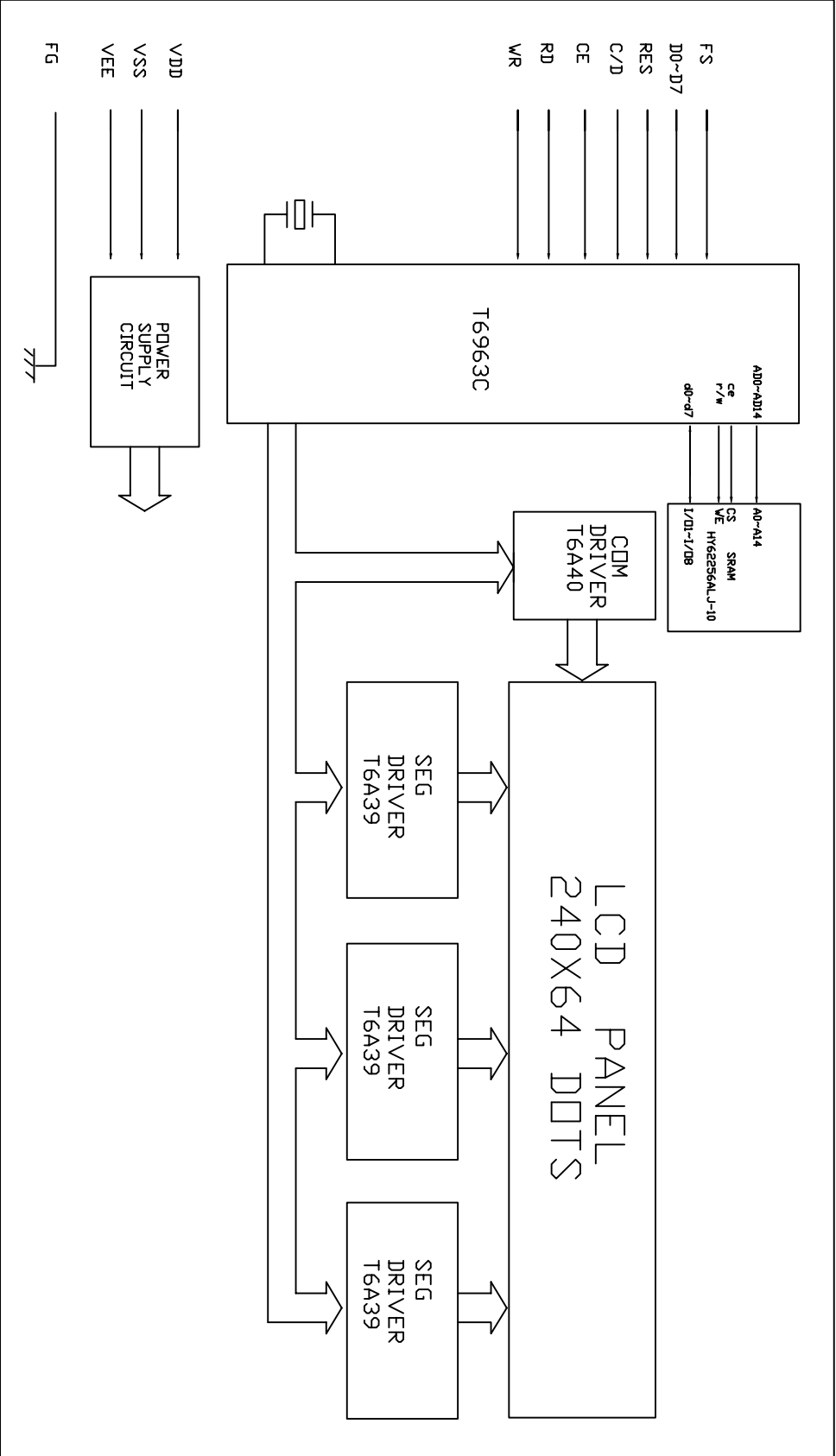

## 5. Absolute Maximum Ratings

Item	Symbol	Min.	Max.	Unit	Remark
Power Supply Voltage	$V_{DD}-V_{SS}$	-0.3	6.0	V	
LCD Driving Voltage	$V_{LCD}$	-	25.0		
Operating Temperature Range	$T_{OP}$	0	+50	°C	No Condensation
Storage Temperature Range	$T_{ST}$	-20	+60		

## 6 Electrical Specifications and Instruction Code

### 6.1 Electrical characteristics

Item	Symbol	Min.	Typ.	Max.	Unit
Supply Voltage (Logic)	$V_{DD}-V_{SS}$	4.75	5.0	5.25	V
Supply Voltage (LCD Drive)	$V_{LCD}$	-	14.3	-	V
Input Signal Voltage	High $V_{IH}$ ( $V_{DD}=5.0$ )	$0.8V_{DD}$	-	$V_{DD}+0.3$	V
	Low $V_{IL}$ ( $V_{DD}=5.0$ )	0	-	$0.2 V_{DD}$	V
Supply current (Logic)	$I_{DD}$ ( $V_{DD}-V_{SS}=5.0V$ )	-	14.0	-	mA
Supply current (LCD Drive)	$I_{EE}$	-	2.0	-	mA
Supply current (LED)	$I_{LED}$			820	mA



## 6.2 Interface Signals

Pin No.	Symbol	Level	Description
1	FG	0V	Frame Ground
2	Vss	0V	Ground
3	Vcc	5.0V	Power supply voltage for logic and LCD(+)
4	Vo	--	Operating Voltage for LCD(variable)
5	WR	L	Write Enable Signal
6	RD	L	Read Enable Signal
7	CE	L	Chip Enable Signal
8	C/D	H/L	H:Instruction;L:Data
9	NC	--	No Signal
10	RESET	L	Reset Signal
11	DB0	H/L	Data bit0
12	DB1	H/L	Data bit1
13	DB2	H/L	Data bit2
14	DB3	H/L	Data bit3
15	DB4	H/L	Data bit4
16	DB5	H/L	Data bit5
17	DB6	H/L	Data bit6
18	DB7	H/L	Data bit7
19	FS	H/L	Font Selection
20	NC	--	No Signal
	LED+	4.2V	Power Supply for LED(+)
	LED-	0V	Power Supply for LED(-)

### 6.3 Interface Timing Chart

#### Bus Timing

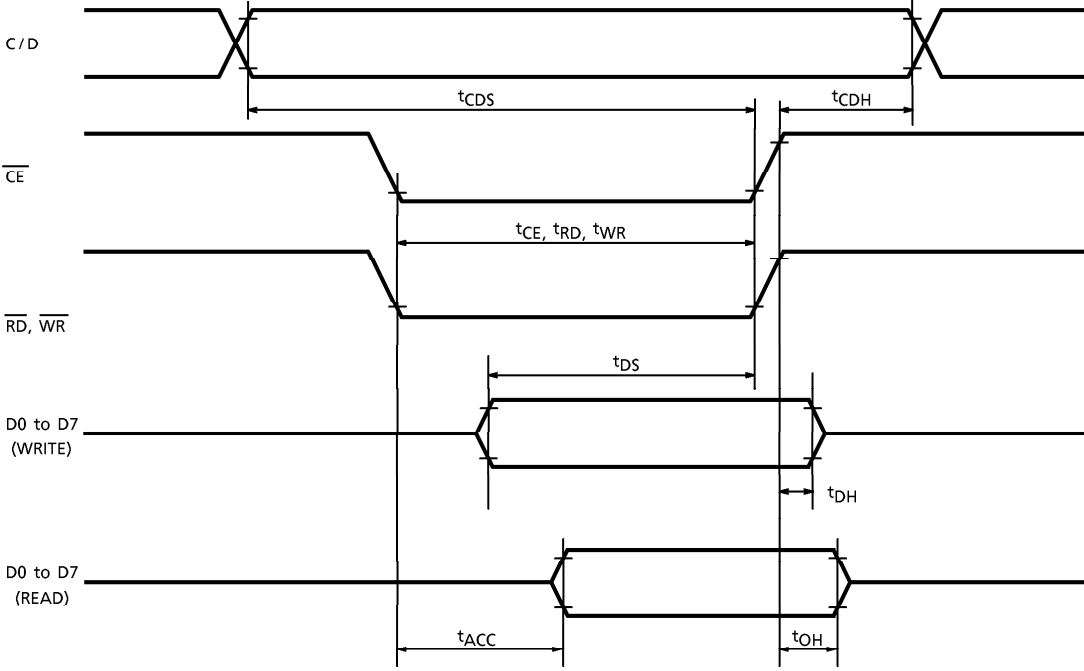

TEST CONDITIONS (Unless otherwise noted,  $V_{DD} = 5.0V \pm 10\%$ ,  $V_{SS} = 0V$ ,  $T_a = -20$  to  $75^\circ C$ )

ITEM	SYMBOL	TEST CONDITIONS	MIN	MAX	UNIT
C/D Set-up Time	$t_{CDS}$	—	100	—	ns
C/D Hold Time	$t_{CDH}$	—	10	—	ns
CE, RD, WR Pulse Width	$t_{CE}, t_{RD}, t_{WR}$	—	80	—	ns
Data Set-up Time	$t_{DS}$	—	80	—	ns
Data Hold Time	$t_{DH}$	—	40	—	ns
Access Time	$t_{ACC}$	—	—	150	ns
Output Hold Time	$t_{OH}$	—	10	50	ns

## 6.4 Instruction Code

COMMAND	CODE	D1	D2	FUNCTION
REGISTERS SETTING	00100001 00100010 00100100	X address Data Low address	Y address 00H High address	Set Cursor Pointer Set Offset Register Set Address Pointer
SET CONTROL WORD	01000000 01000001 01000010 01000011	Low address Columns Low address Columns	High address 00H High address 00H	Set Text Home Address Set Text Area Set Graphic Home Address SetGraphic Area
MODE SET	1000X000 1000X001 1000X011 1000X100 10000XXX 10001XXX	-- -- -- -- -- --	-- -- -- -- -- --	OR mode EXOR mode AND mode Text Attribute mode Internal CG ROM mode External CG RAM mode
DISPLAY MODE	10010000 1001XX10 1001XX11 100101XX 100110XX 100111XX	-- -- -- -- -- --	-- -- -- -- -- --	Display off Cursor on, blink off Cursor on, blink on Text on, graphic off Text off, graphic on Text on, graphic on
CURSOR PATTERN SELECT	10100000 10100001 10100010 10100011 10100100 10100101 10100110 10100111	-- -- -- -- -- -- -- --	-- -- -- -- -- -- -- --	1-line cursor 2-line cursor 3-line cursor 4-line cursor 5-line cursor 6-line cursor 7-line cursor 8-line cursor
DATAAUTO READ/WRITE	10110000 10110001 10110010	-- -- --	-- -- --	Set Data Auto Write Set Data Auto Read Set Reset
DATA READ/WRITE	11000000 11000001 11000010 11000011 11000100 11000101	Data -- Data -- Data --	-- -- -- -- -- --	Data Write and increment ADP Data Read and increment ADP Data Write and Decrement ADP Data Read and Decrement ADP Data Write and Nonvariable ADP Data Read and Nonvariable ADP
SCREEN PEEK	11100000	--	--	Screen Peek
SCREEN COPY	11101000			Screen Copy
BIT SET/RESET	11110XXX 11111XXX 1111X000 1111X001 1111X010 1111X011 1111X100 1111X101 1111X110 1111X111	-- -- -- -- -- -- -- -- -- --	-- -- -- -- -- -- -- -- -- --	bit reset bit set bit0(LSB) bit1 bit2 bit3 bit4 bit5 bit6 bit7(MSB)

X:invalid

## 6.5 Character code map (ROM code 0101)

LSB MSB	0	1	2	3	4	5	6	7	8	9	A	B	C	D	E	F
0		!	"	#	\$	%	&	'	(	)	*	+	,	-	.	/
1	0	1	2	3	4	5	6	7	8	9	:	;	<	=	>	?
2	a	b	c	d	e	f	g	h	i	j	k	l	m	n	o	
3	p	q	r	s	t	u	v	w	x	y	z	[	\	]	^	_
4	\	a	b	c	d	e	f	g	h	i	j	k	l	m	n	o
5	p	q	r	s	t	u	v	w	x	y	z	{		}	~	
6	ÿ	ü	û	ù	ú	û	ü	ý	è	é	ê	ë	ì	í	î	ï
7	ê	ë	ê	ë	ê	ë	ê	ë	ü	ö	ó	ô	õ	æ	œ	š

## 7. Optical Characteristics

### 7.1 Optical Characteristics

Ta=25°C

Item	Symbol	Condition	Min.	Typ.	Max.	Unit	
Viewing Angle	$\theta_x$	$C_r \geq 2$	$\theta_y = 0^\circ$	-2.0	--	30	Deg
	$\theta_y$						
Contrast Ratio	$C_r$	$\theta_x = 0^\circ$ $\theta_y = 0^\circ$	3.0	-	-		
Response Time	Turn on	$\theta_x = 0^\circ$ $\theta_y = 0^\circ$	-	-	300	ms	
	Turn off						300

## 7.2 Definition of Optical Characteristics

### 7.2.1 Definition of Viewing Angle

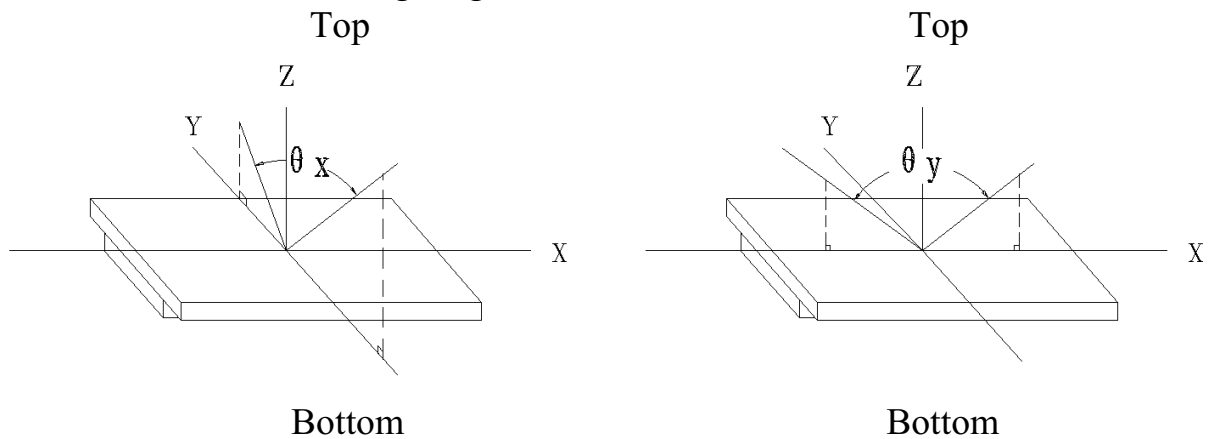

### 7.2.2 Definition of Contrast Ratio

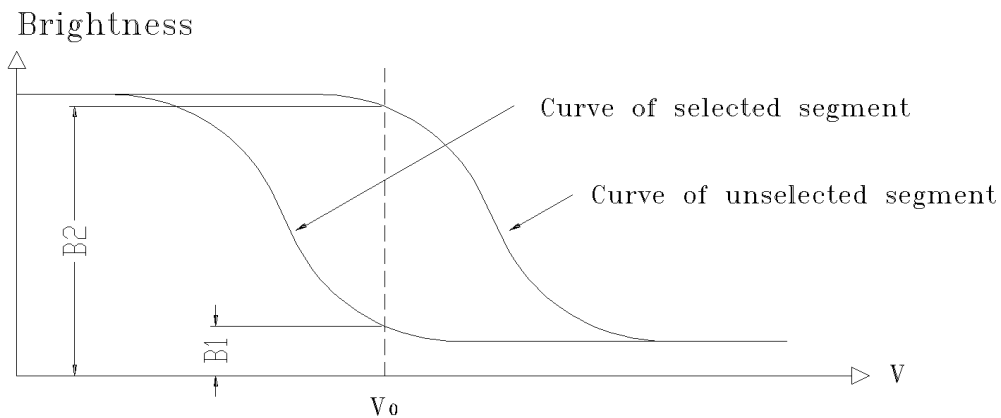

$$\text{Contrast Ratio} = B2/B1 = \frac{\text{unselected state brightness}}{\text{selected state brightness}}$$

Measuring Conditions:

- 1) Ambient Temperature: 25°C ;
- 2) Frame frequency: 64Hz

### 7.2.3 Definition of Response time

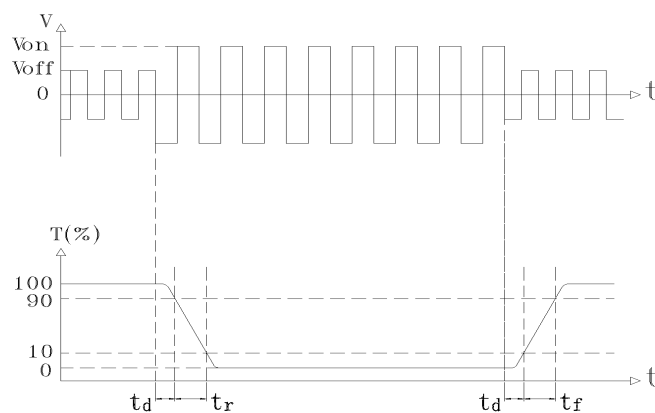

Turn on time:  $t_{on} = t_d + t_r$       Turn off time:  $t_{off} = t_d + t_f$

Measuring Condition:

- 1) Operating Voltage: 11.0V
- 2) Frame frequency: 64Hz

## 8. Reliability

### 8.1 Content of Reliability Test

Ta=25°C

No.	Test Item	Content of Test	Test condition
1	High Temperature Storage	Endurance test applying the high storage temperature for a long time	80°C 240H
2	Low Temperature Storage	Endurance test applying the low storage temperature for a long time	-30°C 240H
3	High Temperature Operation	Endurance test applying the electric stress (voltage & current) and the thermal stress to the element for a long time	70°C 240H
4	Low Temperature Operation	Endurance test applying the electric stress under low temperature for a long time	-20°C 240H
5	High Temperature /Humidity Storage	Endurance test applying the high temperature and high humidity storage for a long time	60°C 95%RH 240H
6	Temperature Cycle	Endurance test applying the low and high temperature cycle $-30^{\circ}\text{C} \longleftrightarrow 25^{\circ}\text{C} \longleftrightarrow 80^{\circ}\text{C} \longleftrightarrow 25^{\circ}\text{C}$ $\begin{array}{cccc} 30\text{min} & 5\text{min} & 30\text{min} & 5\text{min} \end{array}$	-30°C/80°C 10 cycles
7	Vibration Test (package state)	Endurance test applying the vibration during transportation	10Hz~500Hz, 100m/s <sup>2</sup> , 120min
8	Shock Test (package state)	Endurance test applying the shock during transportation	Half- sine wave, 300m/s <sup>2</sup> , 18ms
9	Atmospheric Pressure Test	Endurance test applying the atmospheric pressure during transportation by air	25kPa 16H

## 8.2 Failure Judgment Criterion

Criterion Item	Test Item No.									Failure Judgement Criterion
	1	2	3	4	5	6	7	8	9	
Basic Specification	√	√	√	√	√	√	√	√	√	Out of the basic Specification
Electrical specification	√	√	√	√	√					Out of the electrical specification
Mechanical Specification							√	√		Out of the mechanical specification
Optical Characteristic	√	√	√	√	√	√			√	Out of the optical specification
Note	For test item refer to 8.1									
Remark	Basic specification = Optical specification + Mechanical specification									



## 9. QUALITY LEVEL

Examination or Test	At $T_a=25^\circ\text{C}$ (unless otherwise stated)	Inspection				
		Min.	Max.	Unit	IL	AQL
External Visual Inspection	Under normal illumination and eyesight condition, the distance between eyes and LCD is 25cm.	See Appendix A			II	Major 1.0 Minor 2.5
Display Defects	Under normal illumination and eyesight condition, display on inspection.	See Appendix B			II	Major 1.0 Minor 2.5
Note: Major defects: Open segment or common, Short, Serious damages, Leakage Miner defects: Others Sampling standard conforms to GB2828						

## 10. Precautions for Use of LCD Modules

### 10.1 Handling Precautions

10.1.1 The display panel is made of glass. Do not subject it to a mechanical shock by dropping it from a high place, etc.

10.1.2 If the display panel is damaged and the liquid crystal substance inside it leaks out, be sure not to get any in your mouth, if the substance comes into contact with your skin or clothes, promptly wash it off using soap and water.

10.1.3 Do not apply excessive force to the display surface or the adjoining areas since this may cause the color tone to vary.

10.1.4 The polarizer covering the display surface of the LCD module is soft and easily scratched. Handle this polarizer carefully.

10.1.5 If the display surface is contaminated, breathe on the surface and gently wipe it with a soft dry cloth. If still not completely clear, moisten cloth with one of the following solvents:

- Isopropyl alcohol
- Ethyl alcohol

Solvents other than those mentioned above may damage the polarizer.

Especially, do not use the following:

- Water
- Ketone
- Aromatic solvents

10.1.6 Do not attempt to disassemble the LCD Module.

10.1.7 If the logic circuit power is off, do not apply the input signals.

10.1.8 To prevent destruction of the elements by static electricity, be careful to maintain an optimum work environment.

- a. Be sure to ground the body when handling the LCD Modules.
- b. Tools required for assembly, such as soldering irons, must be properly ground.
- c. To reduce the amount of static electricity generated, do not conduct assembly and other work under dry conditions.
- d. The LCD Module is coated with a film to protect the display surface. Be care when peeling off this protective film since static electricity may be generated.

## 10.2 Storage precautions

10.2.1 When storing the LCD modules, avoid exposure to direct sunlight or to the light of fluorescent lamps.

10.2.2 The LCD modules should be stored under the storage temperature range. If the LCD modules will be stored for a long time, the recommend condition is:

Temperature :  $0^{\circ}\text{C} \sim 40^{\circ}\text{C}$

Relatively humidity:  $\leq 80\%$

10.2.3 The LCD modules should be stored in the room without acid, alkali and harmful gas.

10.3 The LCD modules should be no falling and violent shocking during transportation, and also should avoid excessive press, water, damp and sunshine.

## Appendix A

### Inspection items and criteria for appearance defects

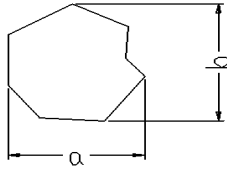
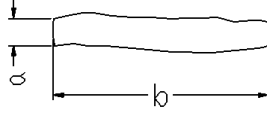
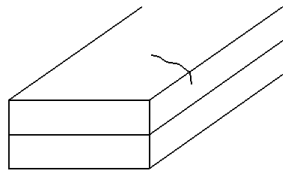
Items	Contents	Criteria			
Leakage		Not permitted			
Rainbow		According to the limit specimen			
Polarizer	Wrong polarizer attachment	Not permitted			
	Bubble between polarizer and glass	Not counted	Max. 3 defects allowed		
		$\phi < 0.3\text{mm}$	$0.3\text{mm} \leq \phi \leq 0.5\text{mm}$		
	Scratches of polarizer	According to the limit specimen			
Black spot (in viewing area)		Not counted	Max. 3 spots allowed	Max. 3 spots (lines) allowed	
		$X < 0.2\text{mm}$	$0.2\text{mm} \leq X \leq 0.5\text{mm}$		
		$X = (a+b)/2$			
Black line (in viewing area)		Not counted	Max. 3 lines allowed		
		$a < 0.02\text{mm}$	$0.02\text{mm} \leq a \leq 0.05\text{mm}$ $b \leq 2.0\text{mm}$		
Progressive cracks		Not permitted			

## Appendix B

### Inspection items and criteria for display defects

Items	Contents	Criteria		
Open segment or open common		Not permitted		
Short		Not permitted		
Wrong viewing angle		Not permitted		
Contrast ratio uneven		According to the limit specimen		
Crosstalk		According to the limit specimen		
Pin holes and cracks in segment (DOT)		Not counted	Max.3 dots allowed	Max.3 dots allowed
		$X < 0.1\text{mm}$	$0.1\text{mm} \leq X \leq 0.2\text{mm}$	
		Not counted	Max.2 dots allowed	Max.3 dots allowed
		$A < 0.1\text{mm}$	$0.1\text{mm} \leq A \leq 0.2\text{mm}$ $D < 0.25\text{mm}$	
Black spot (in viewing area)		Not counted	Max.3 spots allowed	Max.3 spots (lines) allowed
		$X < 0.1\text{mm}$	$0.1\text{mm} \leq X \leq 0.2\text{mm}$	
		$X = (a+b)/2$		
Black line (in viewing area)		Not counted	Max.3 lines allowed	Max.3 spots (lines) allowed
		$a < 0.02\text{mm}$	$0.02\text{mm} \leq a \leq 0.05\text{mm}$ $b \leq 0.5\text{mm}$	

## Appendix B

### Inspection items and criteria for display defects (continued)

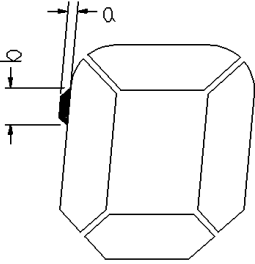
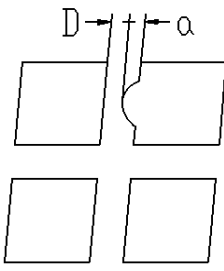
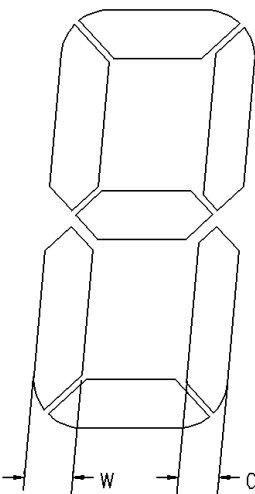
Items	Content	Criteria			
Transformation of segment		Not counted	Max. 2 defects allowed	Max.3 defects allowed	
	$x < 0.1\text{mm}$	$0.1\text{mm} \leq x \leq 0.2\text{mm}$			
	$x = (a+b)/2$				
		Not counted	Max. 1 defects allowed		
	$a < 0.1\text{mm}$	$0.1\text{mm} \leq a \leq 0.2\text{mm}$ $D > 0$			
		Max.2 defects allowed $0.8W \leq a \leq 1.2W$  $a = \text{measured value of width}$ $W = \text{nominal value of width}$			