



7. SILICON BRIDGE RECTIFIERS



T-23-01

The plastic material used in the bridges of 0.5 to 8 ampere rating carries U/L recognition 94V-0.

For Capacitance Load Derate Current by 20%.

Individual Technical Data Sheets Giving Rating and Characteristic Curves are Available

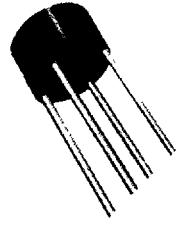
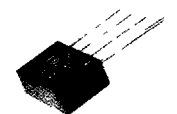
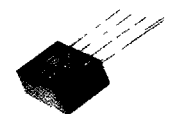
OPERATIONAL TEMPERATURE RANGE -55° to 125°C
STORAGE TEMPERATURE RANGE -55° to 150°C

Type	PRV	Max Avg Rect Current @ Half-Wave Res Load 60Hz		Max Fwd Peak Surge Current 1 ~ 60Hz Superimposed	Max Reverse Current @ PRV Voltage @ 25°C T _A	Max Fwd Voltage @ 25°C T _A		Avalanche Breakdown Voltage		Max Rev Recovery Time			
		I _O	@ T _A			I _{FM} (Surge)	I _R	I _{FM}	V _{FM}		MIN	MAX	t _{rr}
	V _{PK}	A _{AV}	°C	A _{PK}	μA _{dc}	A _{PK}	V _{PK}	V _{PK}		ns			
7-1 1 TO 2 AMPERE/WB OUTLINE													
WB100	50	1.0	25	50	10	1.0	1.0						
WB101	100	1.0	25	50	10	1.0	1.0						
WB102	200	1.0	25	50	10	1.0	1.0						
WB104	400	1.0	25	50	10	1.0	1.0						
WB106	600	1.0	25	50	10	1.0	1.0						
WB108	800	1.0	25	50	10	1.0	1.0						
WB110	1000	1.0	25	50	10	1.0	1.0						
WB150	50	1.5	25	50	10	1.0	1.0						
WB151	100	1.5	25	50	10	1.0	1.0						
WB152	200	1.5	25	50	10	1.0	1.0						
WB154	400	1.5	25	50	10	1.0	1.0						
WB156	600	1.5	25	50	10	1.0	1.0						
WB158	800	1.5	25	50	10	1.0	1.0						
WB1510	1000	1.5	25	50	10	1.0	1.0						
WB200	50	2.0	25	50	10	1.0	1.0						
WB201	100	2.0	25	50	10	1.0	1.0						
WB202	200	2.0	25	50	10	1.0	1.0						
WB204	400	2.0	25	50	10	1.0	1.0						
WB206	600	2.0	25	50	10	1.0	1.0						
WB208	800	2.0	25	50	10	1.0	1.0						
WB210	1000	2.0	25	50	10	1.0	1.0						
3N246	50	1.0	75	30	10	3.14	1.3						
3N247	100	1.0	75	30	10	3.14	1.3						
3N248	200	1.0	75	30	10	3.14	1.3						
3N249	400	1.0	75	30	10	3.14	1.3						
3N250	600	1.0	75	30	10	3.14	1.3						
3N251	800	1.0	75	30	10	3.14	1.3						
3N252	1000	1.0	75	30	10	3.14	1.3						
3N253	50	2.0	55	60	10	3.14	1.1						
3N254	100	2.0	55	60	10	3.14	1.1						
3N255	200	2.0	55	60	10	3.14	1.1						
3N256	400	2.0	55	60	10	3.14	1.1						
3N257	600	2.0	55	60	10	3.14	1.1						
3N258	800	2.0	55	60	10	3.14	1.1						
3N259	1000	2.0	55	60	10	3.14	1.1						
SB200	50	2.0	50	60	10	1.0	1.0						
SB201	100	2.0	50	60	10	1.0	1.0						
SB202	200	2.0	50	60	10	1.0	1.0						
SB204	400	2.0	50	60	10	1.0	1.0						
SB206	600	2.0	50	60	10	1.0	1.0						
SB208	800	2.0	50	60	10	1.0	1.0						
SB210	1000	2.0	50	60	10	1.0	1.0						
SB400	50	4	50	200	10	3.0	1.2						
SB401	100	4	50	200	10	3.0	1.2						
SB402	200	4	50	200	10	3.0	1.2						
SB404	400	4	50	200	10	3.0	1.2						
SB406	600	4	50	200	10	3.0	1.2						
SB408	800	4	50	200	10	3.0	1.2						
SB410	1000	4	50	200	10	3.0	1.2						



10. CONSTRUCTION & OUTLINE DRAWING AXIAL LEAD RECTIFIERS

T-91-20

DO-41 **DO-15** **DO-201AD** **P600** Series

FEATURES

- Low cost, Hi-quality, Hi-reliable.
- Diffused junction.
- Low leakage current.
- High forward surge current capability.
- Plastic molded material with UL recognition 94V-O, the DO-41/DO-15/DO-201AD are per JEDEC molded package.

- Terminals: Plated axial leads solderable per MIL-STD-202 Method 208.
- Polarity: Band denotes cathode.
- Mounting position: Any.
- Weight:

TYPE	DO-41	DO-15	DO-201AD	P600
Ounce	0.012	0.015	0.04	0.06
Gram	0.3	0.4	1.1	1.7

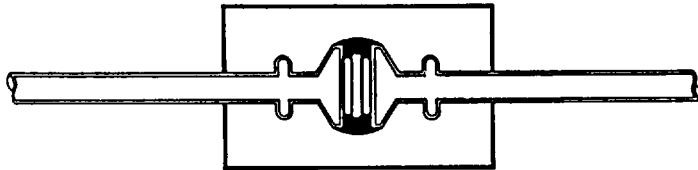

BRIDGE RECTIFIERS

- Lead wires terminals solderable per MIL-STD-202 Method 208.
- Under $T_A = 55^\circ\text{C}$ & rated current operation with no thermal run-away.

WB100 **WB200** Series

FEATURES

- Ratings to 1000V BVR.
 - Surge over-load rating – 50 Amperes Peak.
 - Ideal for printed circuit board.
 - Reliable construction utilized UL recognition 94V-O epoxy.
 - Mounting position: Any.
 - Weight: 0.05 ounce/1.3 gms.
- NOTE: Insulated ceramic case available.

DB600 Series

FEATURES

- Ratings to 1000V BVR.
 - Surge over-load rating – 125 Amperes Peak.
 - Ideal for printed circuit board.
 - Reliable construction utilized UL recognition 94V-O epoxy.
 - Mounting position: Any.
 - Weight: 0.24 ounce/6.9 gms.
- NOTE: Insulated ceramic case available.

SB200 Series

FEATURES

- Ratings to 1000V BVR.
- Surge over-load rating – 60 Amperes Peak.
- Ideal for printed circuit board.
- Reliable construction utilized plastic with UL recognition 94V-O material.
- Mounting position: Any.
- Weight: 0.13 ounce/3.6 gms.

DB1200 **DB1500** **DB2500** **DB3500** Series

FEATURES

- Rating to 1000V BVR.
- Surge over-load rating

TYPE	SURGE CAPABILITY
DB1200	300 Amperes
DB1500	300 Amperes
DB2500	300 Amperes
DB3500	400 Amperes

SB400 Series

FEATURES

- Ratings to 1000V BVR.
- Surge over-load rating – 200 Amperes Peak.
- Ideal for printed circuit board.
- Reliable construction utilized molded plastic with UL recognition 94V-O material.
- Mounting position: Any.
- Weight: 0.18 ounce/4.95 gms.

- Metal case with insulated epoxy coating and very reliable construction.
 - Mounting position: Any.
 - Ideal for printed circuit board.
 - Weight: 1.09 ounce/30 gms.
- NOTE: Insulated ceramic case available.



CASE DRAWINGS

DO41

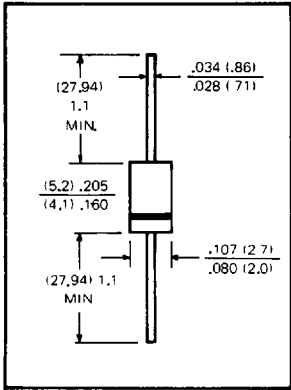

DO15

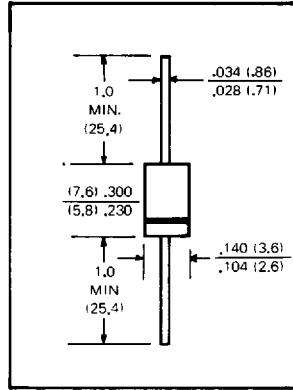

DO201 AD

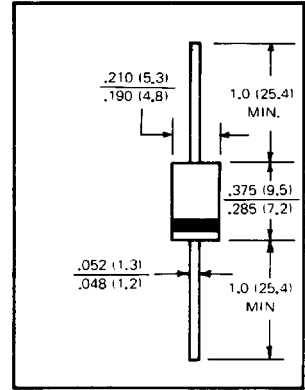

P600

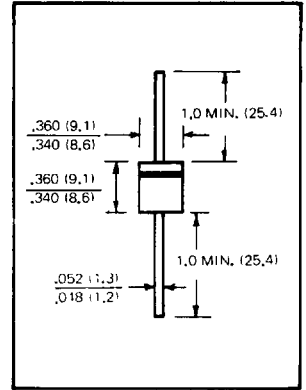

WB100

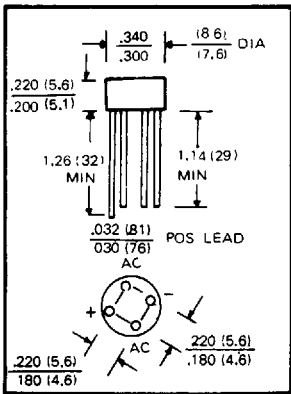

WB200

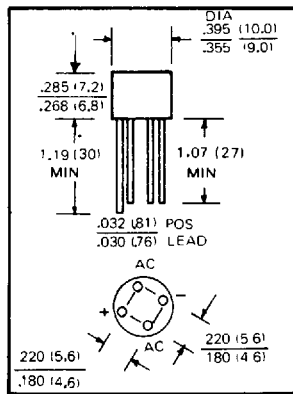

SB200

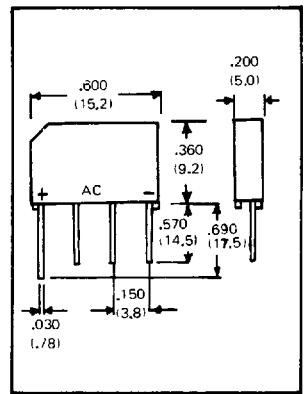

SB400

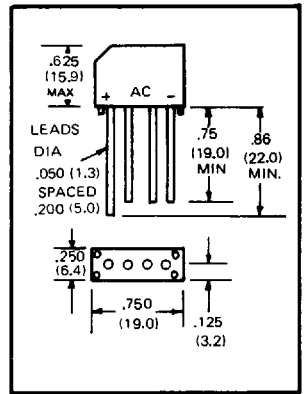

DB600W

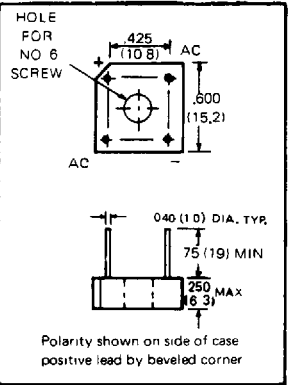

DB600T

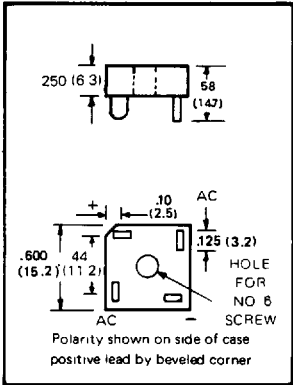

DB1200W

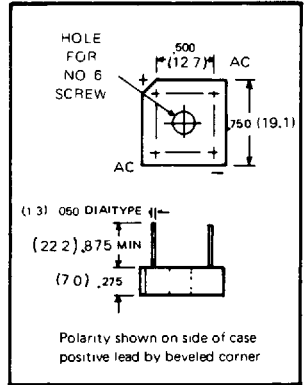

DB1200T

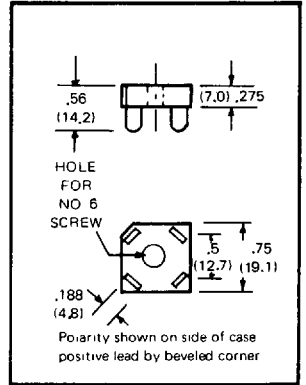

DB2500T

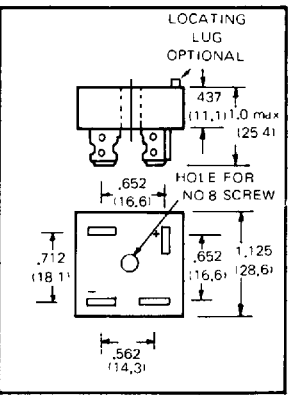

DB2500W

