

# FDK production framework

## ① Features

### ■ Global operation

FDK produces switching power supplies not only in Japan but also in Taiwan and China.

### ■ High-power-factor technology

FDK is a leading creator of technologies for high-power-factor switching power supplies, power-factor-correction (PFC) modules, and PFC hybrid ICs.

### ■ High-efficiency technology

FDK has achieved high efficiency DC-DC converter by applying ASIC to synchronized rectification.

### ■ Intensive packaging technology

FDK has downsized its power supplies by using intensive component packaging techniques involving hybrid ICs, metallic circuit boards and so on.

## ② Production bases

### (In Japan)

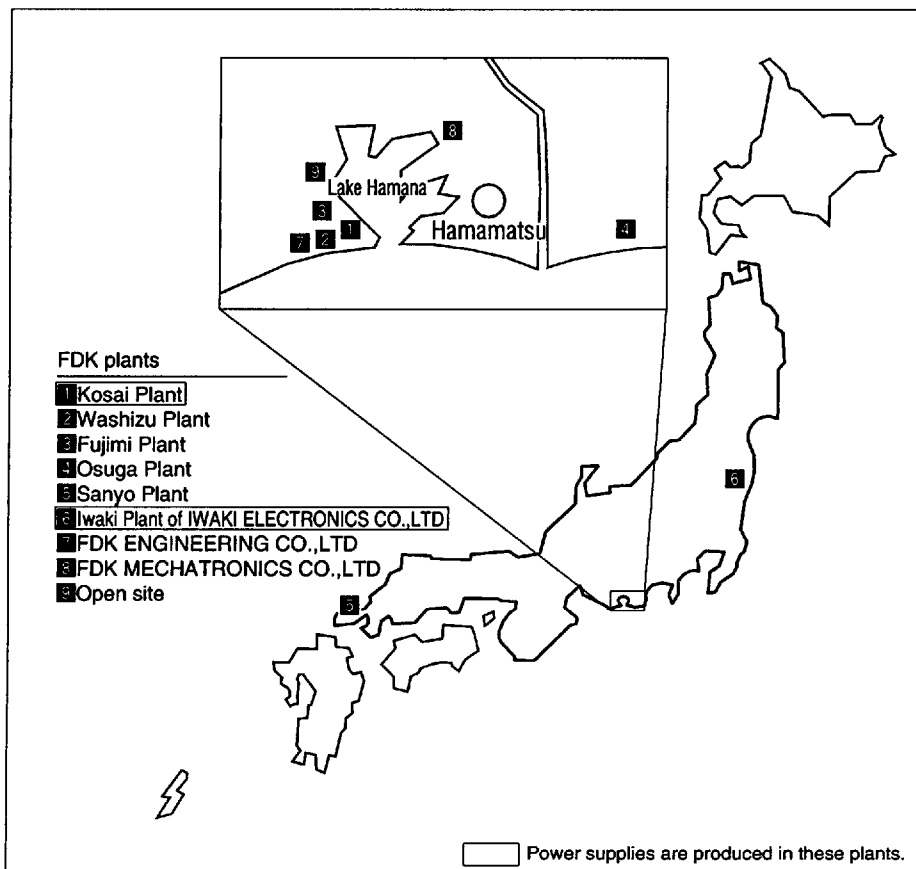

**(Outside Japan)**

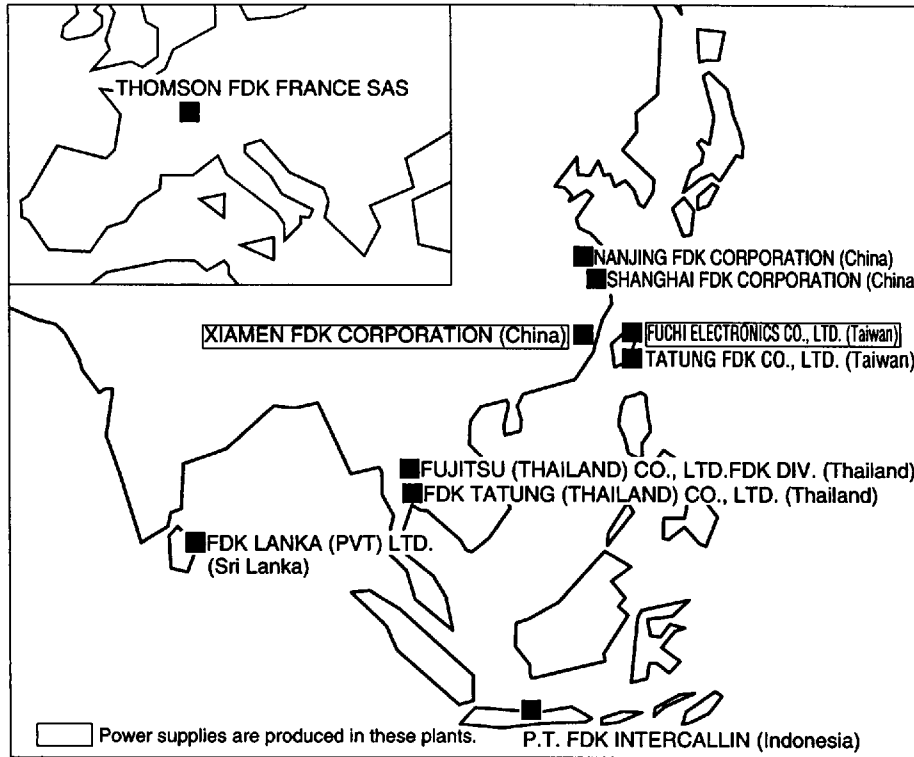

**[Power supply producing plants]**

In Japan, FDK power supplies are developed and produced by IWAKI ELECTRONICS CO.,LTD., which is a wholly owned subsidiary of FDK. Power supplies are also produced in FDK plants in Taiwan and China.

Plant	Power supply technology dept. of IWAKI ELECTRONICS (located inside FDK's Kosai Plant ground)	Iwaki Plant of IWAKI ELECTRONICS	FUCHI ELECTRONICS (Taiwan)	XIAMEN FDK (China)
Capital	100% owned by FDK		100% owned by FDK and IWAKI ELECTRONICS	100% owned by FDK
Main role	Development and design of medium to large power supplies (PS)	Development and design of small PS and CV; production of intensively packaged PS and CV; production of small-lot and trial products	Production of medium- to large-lot products; development and design of low-priced models	Production of large-lot power supplies

PS : Power supplies  
CV : DC - DC converters

**③ Global sales operation**

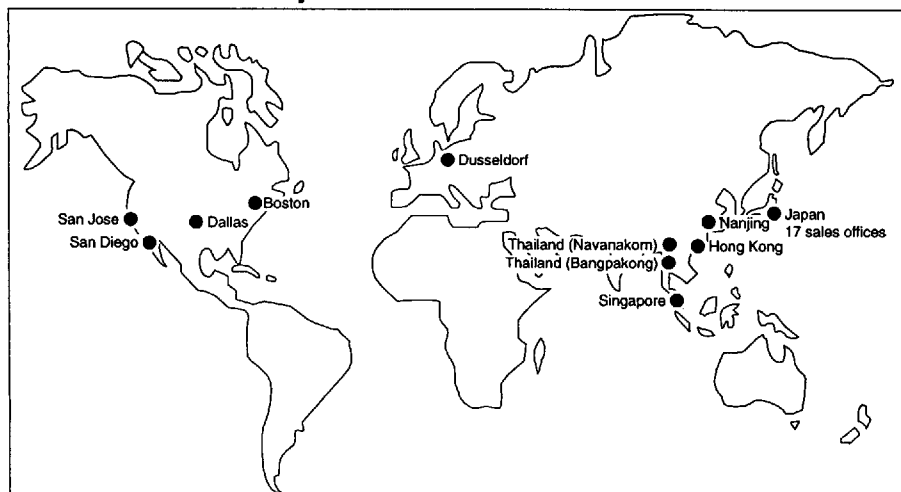

#### ④ FDK's power supply plants



##### **FDK Kosai Plant**

- The main plant
- Backed by the FDK R&D Center
- One of the Center's task is to develop and design medium to large power supplies.



##### **Iwaki Plant of IWAKI ELECTRONICS CO.,LTD.**

- IWAKI, a wholly owned subsidiary of FDK, manufactures power supplies, hybrid ICs and other assembled products.
- The coordinator of FDK's entire power supply manufacturing operation.
- Develops and designs small to medium power supplies and DC-DC converters.
- Produces trial, small-lot, large-sized and high-reliability power supplies, along with DC-DC converters.
- Also produces control-use hybrid ICs and high-density DC-DC converters using metallic circuit boards.

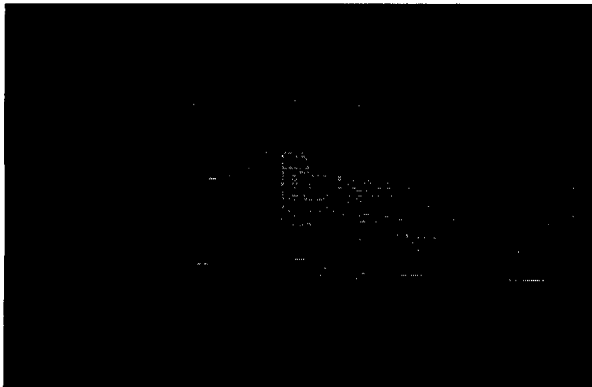

##### **XIAMEN FDK CORPORATION in Xiamen, China**

- Founded in 1994 to supply lower-priced products.
- The new plant completed in February 1998.
- Produces smaller-capacity power supplies in large lots.
- FDK's central overseas plant, also produces motors and hybrid ICs



##### **FUCHI ELECTRONICS CO.,LTD. in Tao Yuan, Taiwan**

- Produces power supplies and hybrid ICs; production of power supplies began in 1988.
- Emphasizes large-lot production of smaller-capacity power supplies.

**⑤ Development and production systems**

**① High-frequency power ferrite cores**

FDK develops and produces ferrite cores for use in:

- TV deflection yokes
- VCR rotary transformers
- Switching power supply transformers/choke coils.

Ferrite technology is fully utilized in FDK's switching power supplies.

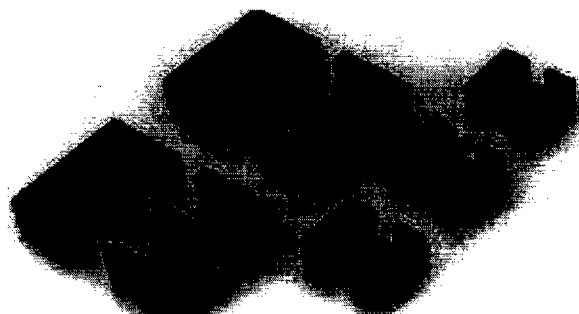

**② Design simplified and standardized by CAD**

CAD and CAM systems play a crucial role in the design and production of switching power supplies.

- Development time is reduced.
- Quality upgraded.
- Delivery periods are shortened.
- Product prices lowered.

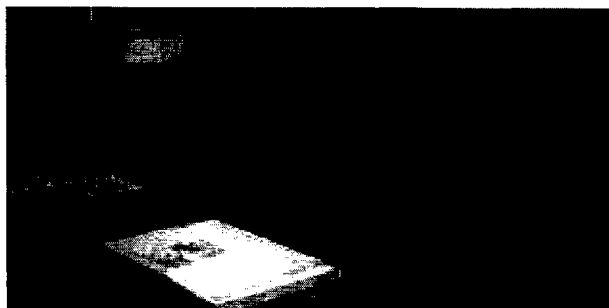

**③ Intensive packaging through Hybrid ICs**

The hybrid ICs developed and produced by IWAKI ELECTRONICS are applied to the downsizing and intensive packaging of our switching power supplies.



**④ Sufficiency in transformers/choke coils**

The production capacity for switching power supplies is enhanced by:

- Acquiring automatic winding machines
- Operating a specialized transformer/choke coil plant.



**⑤ Automated helpers in circuit packaging**

The mounting and packaging of components on circuit boards are automated to the highest degree in order to achieve:

- Higher quality
- Faster delivery
- Lower cost

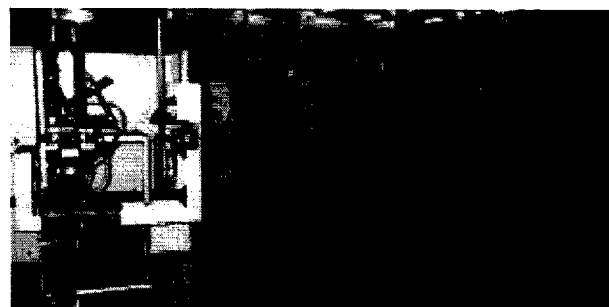

**6 Quality screening by aging tests**

All new power supplies fresh off the assembly line undergo a high-temperature aging process to weed out defective products at an early stage.

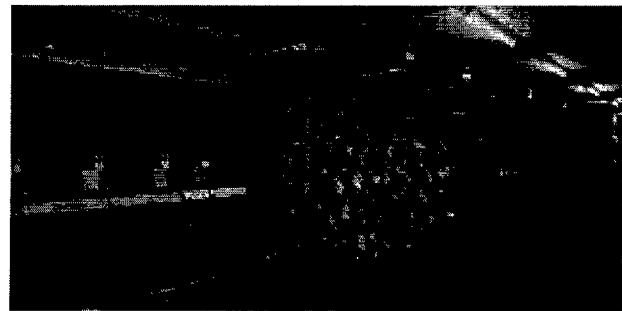

**7 Quality assurance by measuring systems**

Tuning, testing and inspections are performed by automated measuring systems to assure the quality of FDK's switching power supplies.

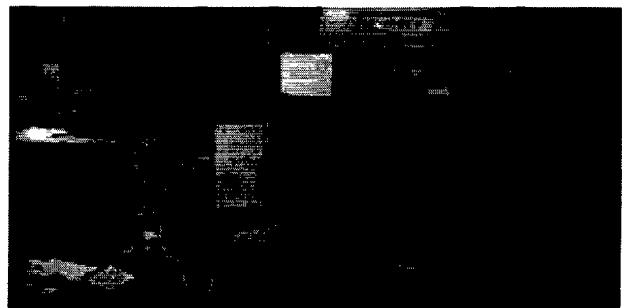

**8 Reliability tests on engineering samples**

Thorough reliability tests are performed on engineering samples of power supplies so that the end products will perform at their intended levels.

- Electric characteristics test
- Mechanical characteristics test
- Safety confirmation test, etc

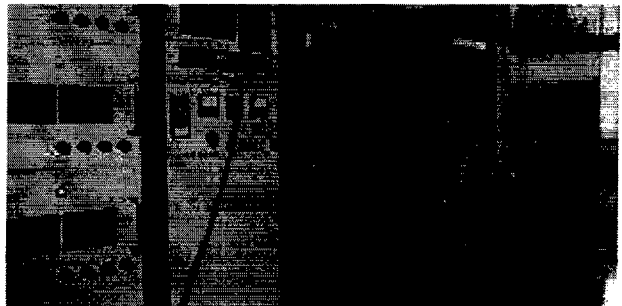

**9 Noise control through noise measurement**

FDK operates advanced noise-measuring facilities to rule out noise problems not only from its switching power supplies but from equipment incorporating power supplies.

- Terminal noise control
- Radiation noise control

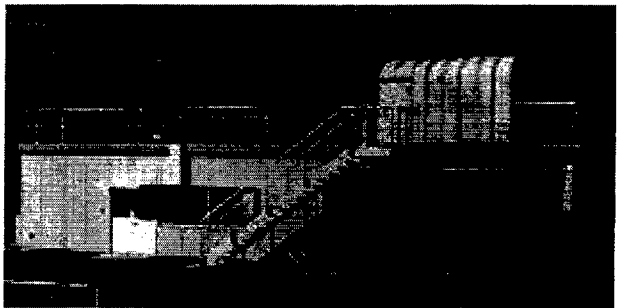

**10 Meeting international standards**

FDK can quickly meet UL, CSA, IEC and other international safety standards with respect to customized switching power supplies. In addition, all of its power supply plants are ISO-9002-approved. Thus these plants are internationally recognized as being capable of assuring quality.

# FDK's power supply technologies

## ① Power factor correction (PFC) circuit technology

### ● Purpose of power factor correction

PFC circuits are intended to modify the input current waveform so as to resemble an input voltage waveform or, in other words, to achieve a power factor that is close to 1. There are three major purposes of power factor correction, as outlined below.

- **Control of high-harmonic current**  
Many countries regulate high-harmonic current, which adversely affects power facilities, in response to the IEC 1000-3 Standard.
- **Reduction of peak input current**  
Peak input current needs to be lowered so as to stay below the current capacities of power equipment and capacitors.
- **Compatibility with world input voltages**  
Automatic compatibility over a wide range of input voltages from 90V to 264V is achieved by PFC circuits equipped with rising voltage capacitors.

PFC and conventional circuits

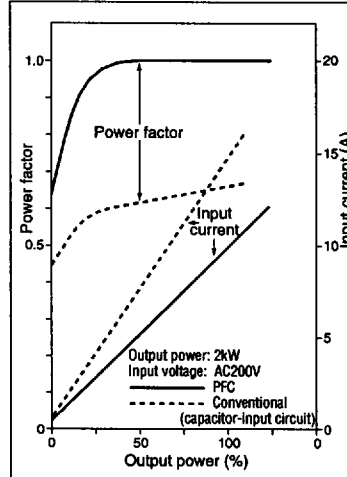

PFC characteristics

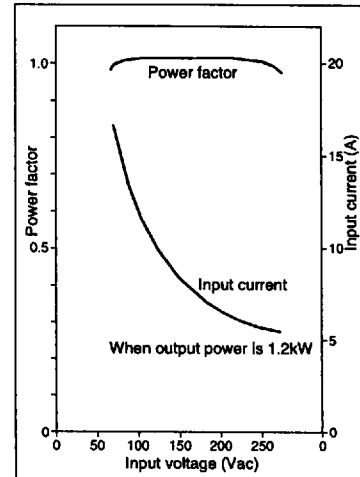

## PFC block diagram and operation waveform

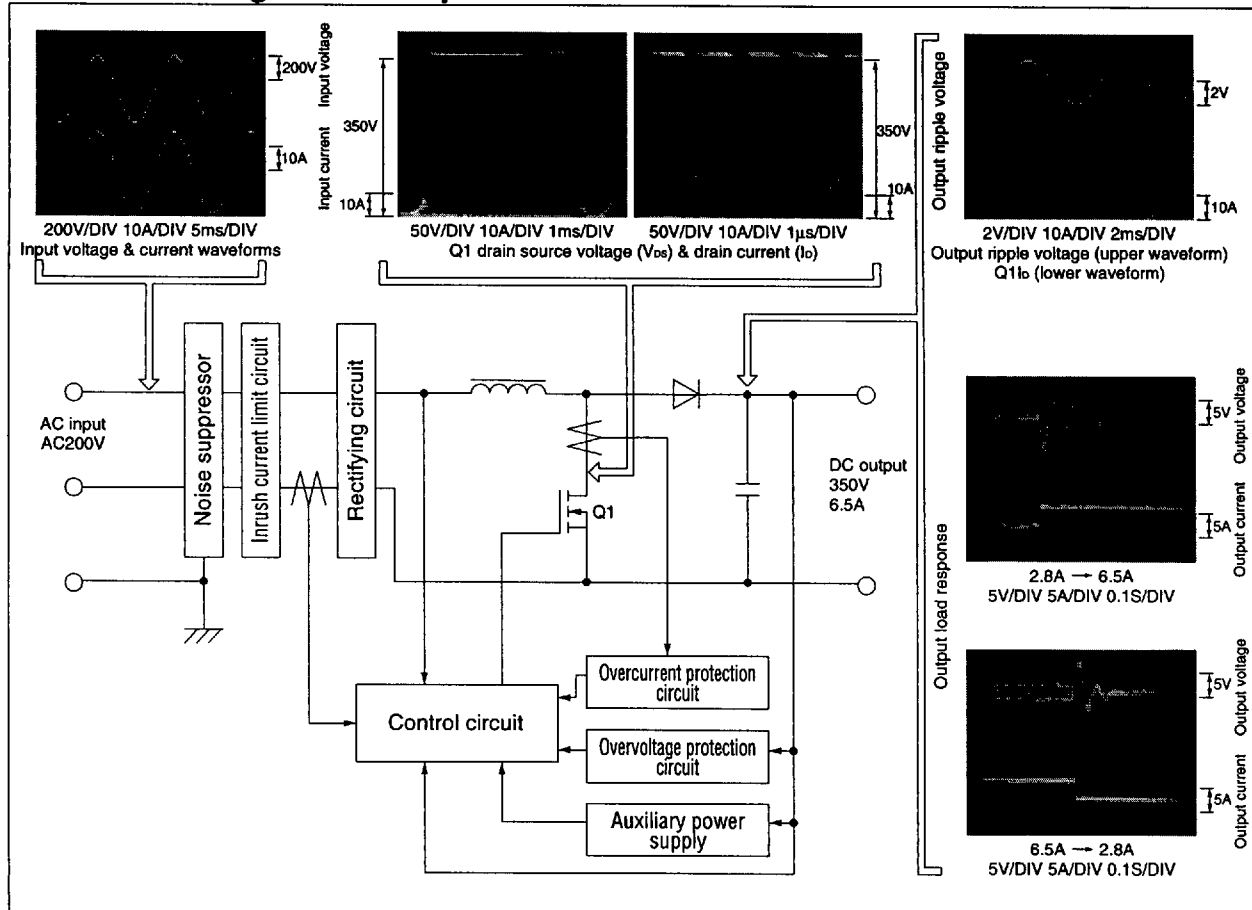

● Input current reduction effect of PFC

Because switching power supplies adopt the capacitor input rectification method, the input current peak is very high, thereby pushing down the power factor to 0.6 or 0.7.

As shown by the equation below, however, the input current can be reduced if the power factor is improved toward 1.

$$\text{Input current} = \frac{\text{Output power}}{\text{Efficiency} \times \text{Power factor} \times \text{Input voltage}}$$

**Comparison of FDK switching power supplies with and without PFC (when using a 2kW output DC-DC converter)**

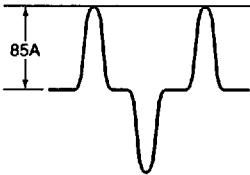
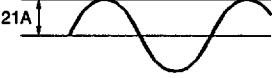
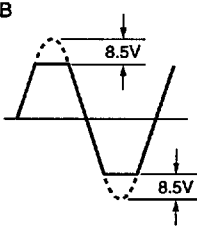
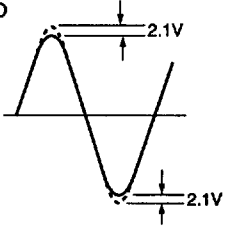
Circuit type	Conventional (without PFC)	With PFC
Description	FDK's conventional switching power supplies without PFC are operated by pulse current, so that the peak current is 3 to 5 times higher than the effective input current (see Fig.A). This is accompanied by a drop in the input voltage due to the impedance of the input power supply line, thus causing distortions in the input voltage waveform (Fig.B). Moreover, since the input pulse current does not have a sine waveform, it contains many harmonic elements which are likely to generate noise.	FDK's new switching power supplies incorporating PFC enable the input current to have a sine waveform in proportion to the input voltage. The pulse current is thus eliminated, and the peak value of the input current is lowered (see Fig.C). Further, voltage drops and waveform distortions are also forestalled.
Input voltage range	AC 85-132V or AC 170-264V	85VAC-264VAC
Input current	21A (200VAC)	15A (200VAC)
Input current waveform	Fig.A 	Fig.C 
Power factor	0.6-0.7 (200VAC)	0.95 or more (AC 200V)
Input voltage waveform distortions (Line impedance: 0.1Ω)	Fig.B 	Fig.D  (Waveform distortions eliminated)

② PFC Products

**PFC modules: PFCM300-03**

Taking advantage of intensive packaging technology, these PFC modules incorporate an inrush current-limiting circuit (with an external resistor), an input rectifier, an inductor, and an auxiliary power supply circuit all in one compact unit. Using a PFC module, it is easy to enable switching power supplies to meet the harmonic wave regulations without the help of many external components.

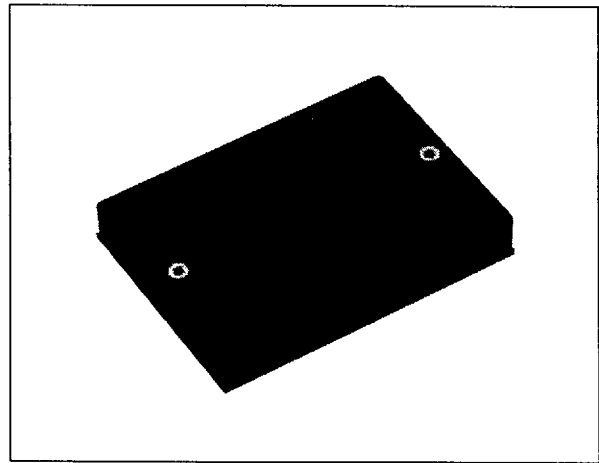

**Features**

- Variable switching frequency
- DIP [13.7(H) × 65(W) × 90(L) mm]
- Built-in protection circuits
  - \*Overvoltage protection
  - \*Overcurrent protection
  - \*Thermal protection
- Conformity with major safety standards
  - \*UL 1950
  - \*CSA 234
  - \*IEC 950/EN 60950

**Example of PFC module application (improving the power factor of a switching power supply)**

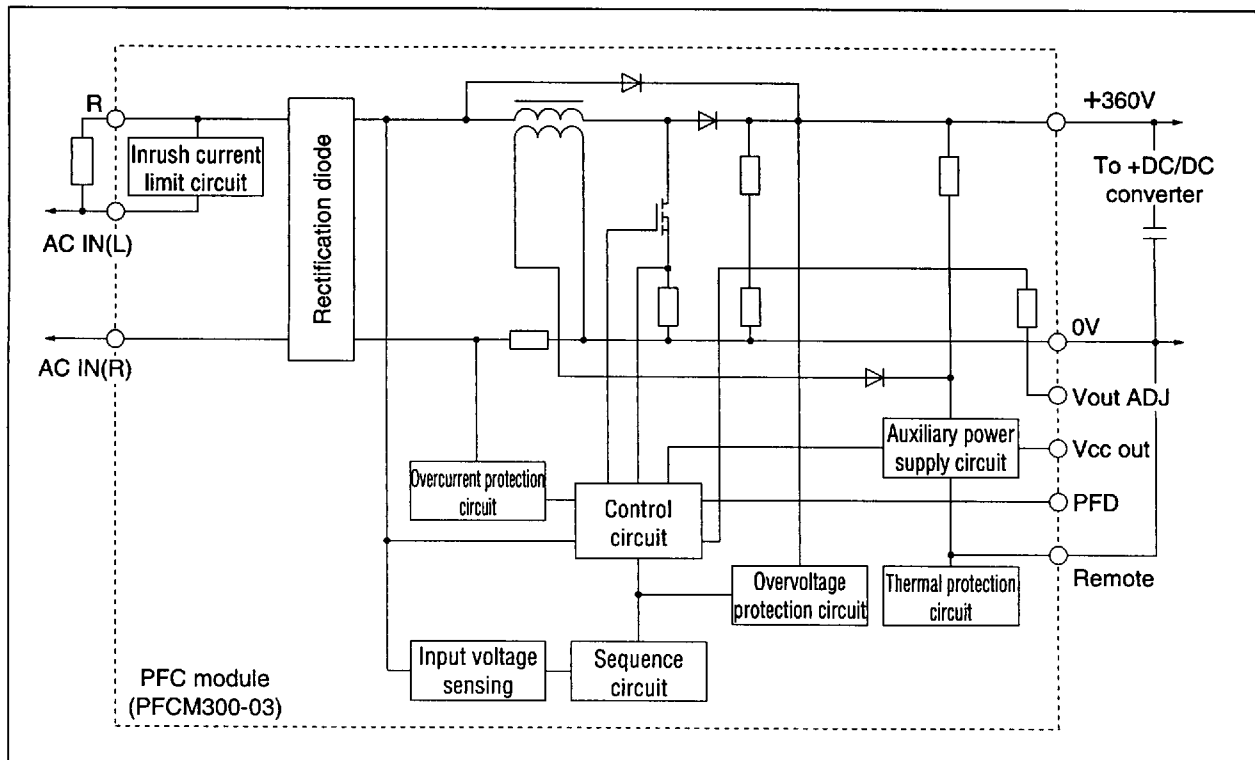



**Electrical characteristics of PFC modules**

Item	PFCM300-03	Remarks
Input voltage	AC85V~AC264V	Operation startup voltage : AC60~70V
Output voltage	DC360V±2%	
Output power	300Wmax./600Wmax.	100V/200V systems
Output voltage variation	±2%	Line regulation Load regulation
Output ripple	8V/16V	100V/200V systems
Efficiency	90%typ./94%typ.	100V/200V systems
Power factor	0.95Vmin.	
Overvoltage protection	390V±5V	
Thermal protection	100°C	Aluminum substrate surface temperature
Auxiliary power supply output	12V~18V 10mAmax.	
Isolation resistance	100MΩmin.	Terminal-to-casing when DC 500V
Isolation withstand voltage	AC1500V for 1 min.	Terminal-to-casing

**Shape and dimensions**

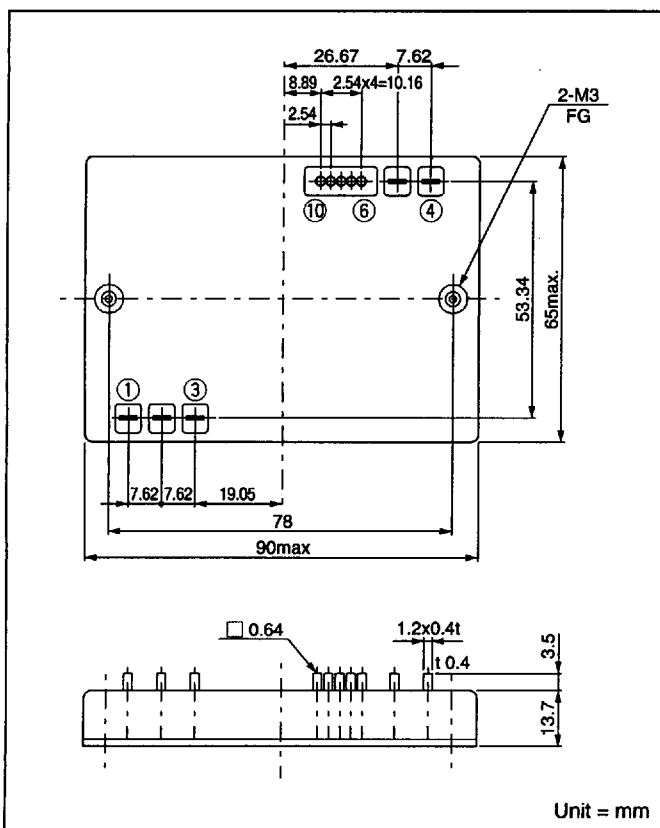

**Terminal name and function**

Pin No.	Terminal code	Function
①	AC IN (L)	AC input terminal (L)
②	R	Terminal for connecting an inrush prevention resistance
③	AC IN (R)	AC input terminal (N)
④	360V (+)	+360V output terminal
⑤	0V	+360V return
⑥	Remote	Remote control terminal
⑦	Vout Adj	Terminal for output voltage adjustment
⑧	Vcc Out	Output terminal of auxiliary power supply
⑨	PFD	Operation confirmation signal output terminal
⑩	GND	Grounding

Made to order

# PFC control hybrid ICs

By adopting a continuous current formula, these PFC circuit control ICs minimize the amount of the rated current required by peripheral circuit components, thereby enabling the host equipment to meet the harmonic wave regulations. They are designed for power supplies of up to several kW capacity.

## Features

- Compatible with a wide range of output power thanks to the large drive output current ( $I_o = \pm 2A$ )
- ON/OFF control possible by using external signals

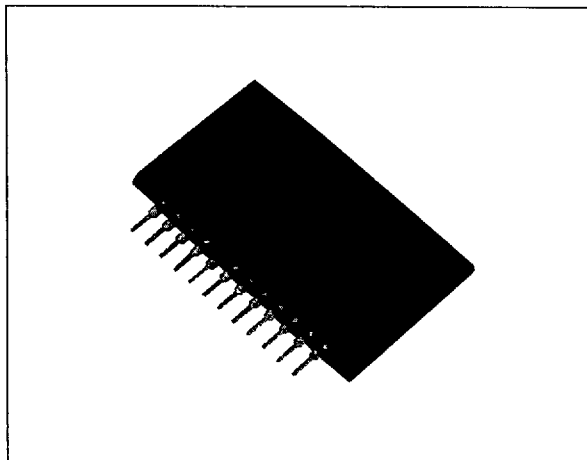

## Example of PFC control hybrid IC application

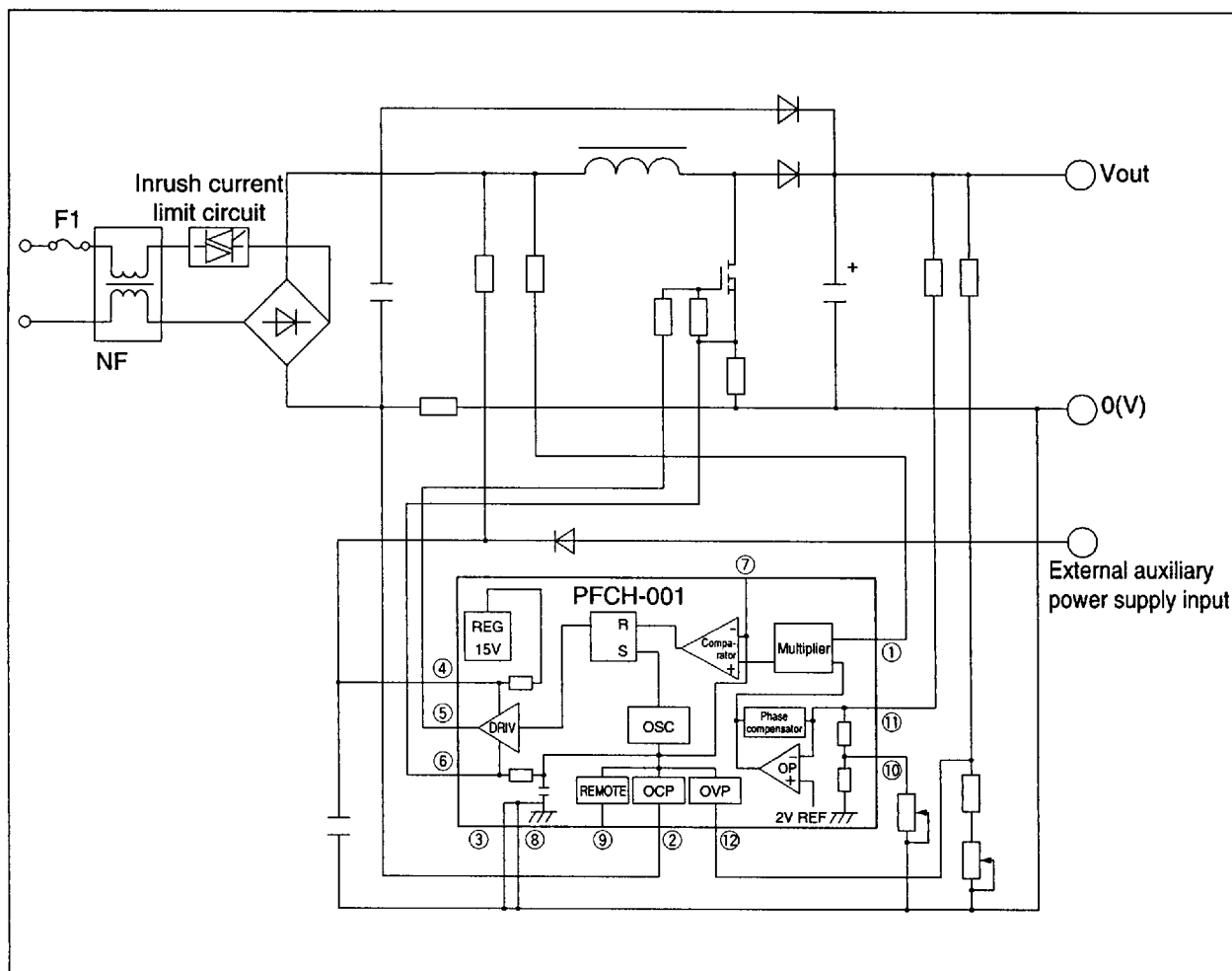

**Absolute maximum rating of PFC control hybrid ICs**

Item	Symbol	Min. value	Max. value	Unit
Supplied voltage	Vcc	—	18	V
Comparator input voltage	ISENSE1,2	-0.3	20	V
Control amplifier input	VSENSE	-0.3	6	V
Multiplier input current	I in SENSE	—	100	mA
Overvoltage protection input	Vovp	-0.3	7	V
Overcurrent protection input	Vocp	—	-1	V
Drive circuit output current	Io	—	±2	A
Operating temperature	Topr	-25	85	°C
Non-operating temperature	Tsts	-30	105	°C

**Recommended operating conditions**

Item	Symbol	Min. value	Max. value	Unit
Supplied voltage	Vcc	12	15	V
Comparator input	ISENSE1,2	0	3.5	V
Control amplifier input	V SENSE	0	3.5	V
Multiplier input	V in SENSE	0	1.6	V

**Shape and dimensions**

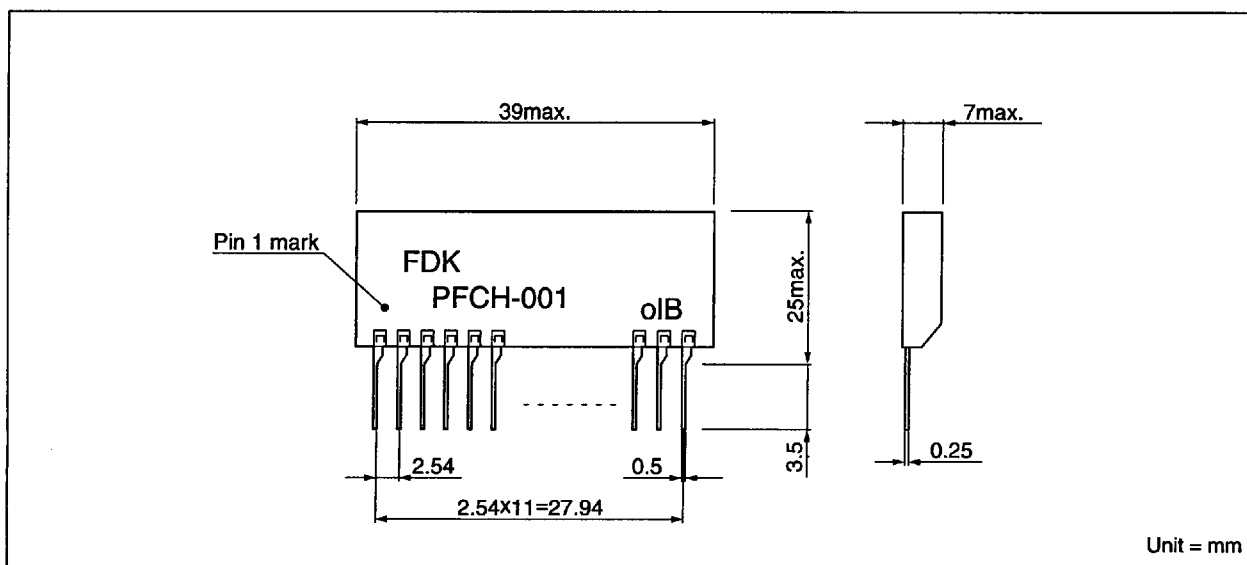

**Terminal name and function**

Pin No.	Name	Function
①	V in sense	Multiplier input
②	OCP	Overcurrent detection input
③	GND 1	Ground
④	Vcc	Auxiliary power supply input
⑤	OUT	Switching element drive output
⑥	I sense 1	Current comparator input 1
⑦	I sense 2	Current comparator input 2
⑧	GND 2	Ground
⑨	REMOTE	ON/OFF control input
⑩	V out adj.	Output voltage adjustment by external resistor
⑪	V sense	Output voltage detection input
⑫	OVP	Overvoltage detection input

Made to order

## High-efficiency intensive-packaging technology

As electronic equipment is downsized, switching power supplies and DC-DC converters must be made more compact, lightweight and flat. Surface packaging technology is utilized for higher-density packaging. In addition, the internal loss and heat release of the switching power supply must be improved.

- ① FDK adopts a synchronized rectification method so as to boost efficiency, which in turn improves the internal loss.
- ② FDK uses single-surface or double-surface metallic boards to enhance the heat release performance.

We recommend various combinations of these steps to our customers, so that the best overall balance is achieved as a total electronic system.

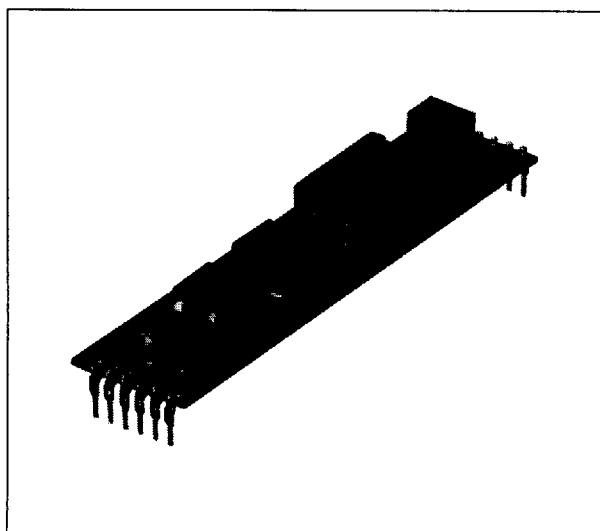

Example of intensive packaging by using a double-surface metallic circuit board

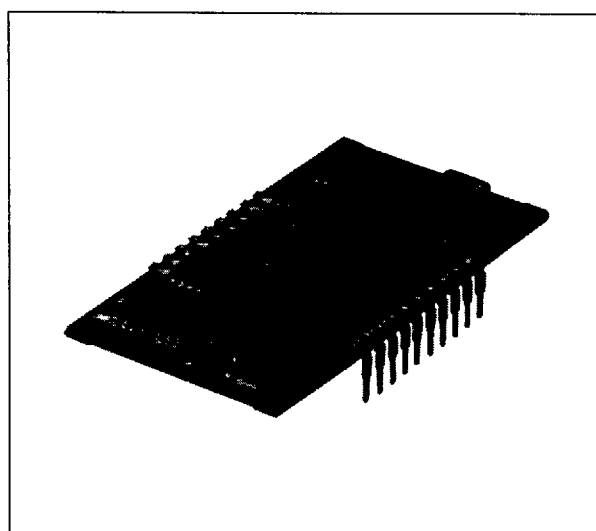

Example of high-efficiency packaging through the synchronized rectification method

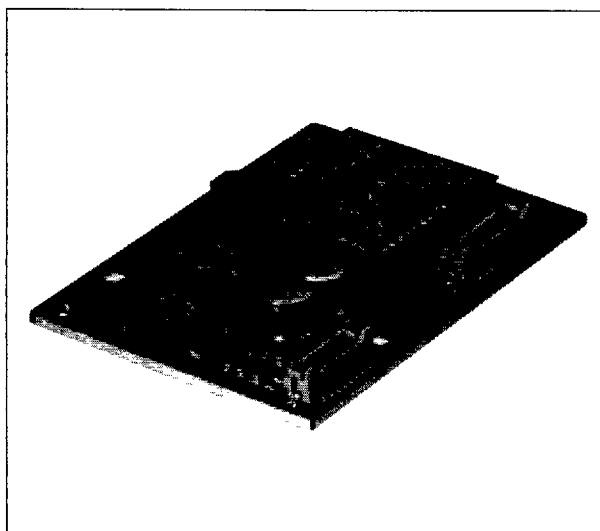

Example of intensive packaging by using a single-surface metallic circuit board

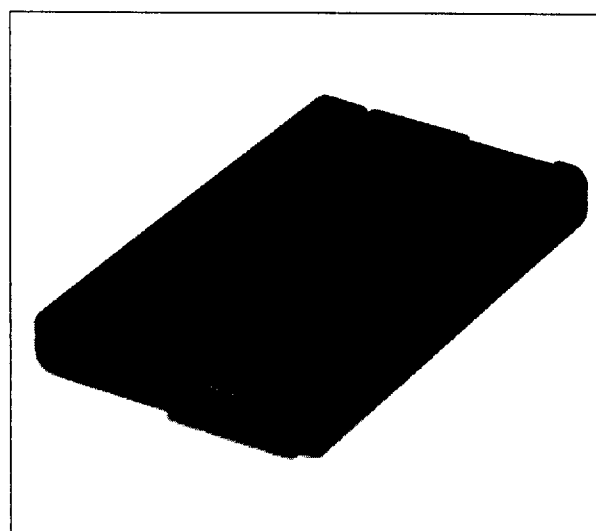

Example of intensive packaging by using a double-surface metallic circuit board

# Customized switching power supplies

## ■ Customized switching power supplies for personal computers

Designed for desk-top PCs that automatically adjust input voltage in order to meet the harmonic wave regulations, these power supplies have a 150W-4ch output and provide separate 100V and 200V input voltage options.

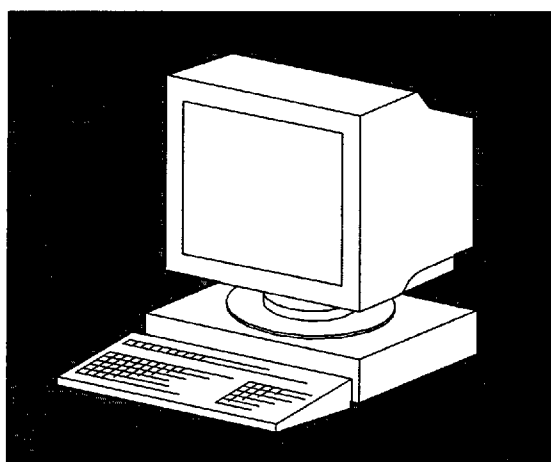

### Characteristics (examples)

Item		Rated value			
Input	Input voltage	AC 100V/200V (AC 90~132V or AC 187~276V)			
	Frequency	50/60Hz (48~62Hz)			
	Inrush current	42Amax.			
	Efficiency	60%min.			
	Power factor	IEC 100-3-2			
Output	Channels	ch1	ch2	ch3	ch4
	Output voltage	+5.0V	+12.0V	-12.0V	-5.0V
	Rated current	13A	3.5A	0.3A	0.3A
	Current range	1.5~18A	0~4.2A	0~0.5A	0~0.5A
	Ripple/noise	150mV	360mV	360mV	150mV
	Overall regulation	+5%~4%	±5%	±10%	+10%~8%
	Overvoltage protection	+5.6~+6.8V	+13.6~+15.6V	—	—
	Overcurrent protection	Short circuit protection	Short circuit protection	Short circuit protection	Short circuit protection
Ambient conditions	Operating temp./humidity	0~+50°C, 20~80%RH (No dew deposit)			
	Non-operating temp./humidity	-10~+70°C, 10~90%RH (No dew deposit)			
	Vibration	0.5G, 1~100~1Hz/60sec, XYZ directions, 10 min. each			
	Shock	40G, 10msec, XYZ directions, 3 times each			
Construction, dimensions	Dimensions	150 × 140 × 86mm			
	Casing	Encased			
	Thermal radiation	Built-in fan			
	Thermal protection	—			
Standards	Noise standards	VCCI class II, FCC-B, VDE-B			
	Safety standards	UL1950, IEC950, CSA C22.2 950, Denki Yohin (JAPAN)			

**Customized switching power supplies for work stations**

These are 150W-3ch switching power supplies for work stations with built-in active filters, and conform to worldwide input voltage or harmonic wave regulations.

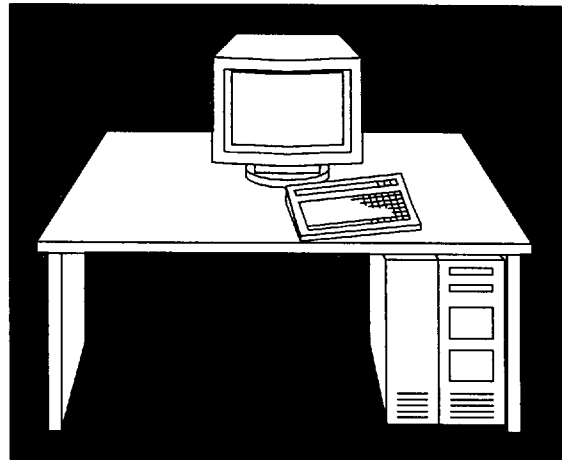

**Characteristics (examples)**

Item		Rated value		
Input	Input voltage	AC 100V/200V (AC 87~264V)		
	Frequency	50/60Hz (47~66Hz)		
	Inrush current	60Amax.		
	Efficiency	65%min.		
	Power factor	0.95 or more (with a built-in active filter)		
Output	Channels	ch1	ch2	ch3
	Output voltage	+5.0V	+12.0V	-12.0V
	Rated current	25A	2.0A	0.1A
	Current range	2.0~25A	0.2~3.5A	0~0.4A
	Ripple/noise	50mV	100mV	100mV
	Overall regulation	±3%	±5%	±5%
	Overvoltage protection	6.0~7.0V	13.0~16.0V	—
	Overcurrent protection	29.0~35.0A	8.0~12.0A	0.5~2.0A
Ambient conditions	Operating temp./humidity	0~+50°C, 10~90%RH (No dew deposit)		
	Non-operating temp./humidity	-40~+70°C, 0~95%RH (No dew deposit)		
	Vibration	1.0G, 5~300~5Hz, XYZ directions, 30 min. each		
	Shock	40G, 11msec, XYZ directions, 3 times each		
Construction, dimensions	Dimensions	200 × 100 × 70mm		
	Casing	Encased		
	Thermal radiation	Built-in fan		
	Thermal protection	—		
Standards	Noise standards	VCCI class II, FCC-A, VDE-A		
	Safety standards	UL1950, IEC950, CSA C22.2 950, Denki Yohin (JAPAN)		

**■ Customized switching power supplies for word processors**

Intended for laptop word processors, these are small-capacity and multi-output (27W-6ch) power supplies for driving stepper motors, thermal printing heads, etc.

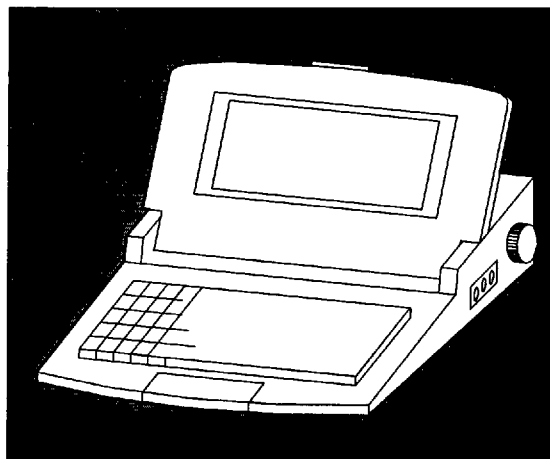

**Characteristics (examples)**

Item		Rated value					
Input	Input voltage	AC 100V (AC 90~110V)					
	Frequency	50/60Hz (48~62Hz)					
	Inrush current	35Amax.					
	Efficiency	65%min.					
	Power factor	—					
Output	Channels	ch1	ch2	ch3	ch4	ch5	ch6
	Output voltage	+5.0V	+12.0V	-12.0V	-24.0V	+24.0V	+44.0V
	Rated current	0.55A	0.5A	0.05A	0.01A	0.7A	0.02A
	Current range	0.2~1.7A	0.01~1.3A	0.01~0.1A	0~0.1A	0.15~2.2A	0~0.12A
	Ripple	50mV	200mV	200mV	100mV	300mV	100mV
	Overall regulation	±5%	±10%	±10%	±10%	-7%+35%	±5V
	Overvoltage protection	—	—	—	—	—	—
	Overcurrent protection	Short circuit protection	Short circuit protection	Short circuit protection	—	—	—
Ambient conditions	Operating temp./humidity	0~+50°C, 10~95%RH (No dew deposit)					
	Non-operating temp./humidity	-20~+70°C, 10~95%RH (No dew deposit)					
	Vibration	1.5G, 10~100~10Hz/6min., XYZ directions, 1 hr. each					
	Shock	Packaged drop from 90cm height, 10 times					
Construction, dimensions	Dimensions	98 × 190 × 34mm					
	Casing	Open frame					
	Thermal radiation	Natural cooling					
	Thermal protection	—					
Standards	Noise standards	VCCI class II					
	Safety standards	Denki Yohin (JAPAN)					

**■ Customized switching power supplies for fax machines**

These switching power supplies are suited for compact fax machines using A4 thermo-sensitive papers. They provide separate 100V and 200V input voltage options, and they have +5V, +24V and ±12 output channels, a 30W rated output, and a 130W peak output.

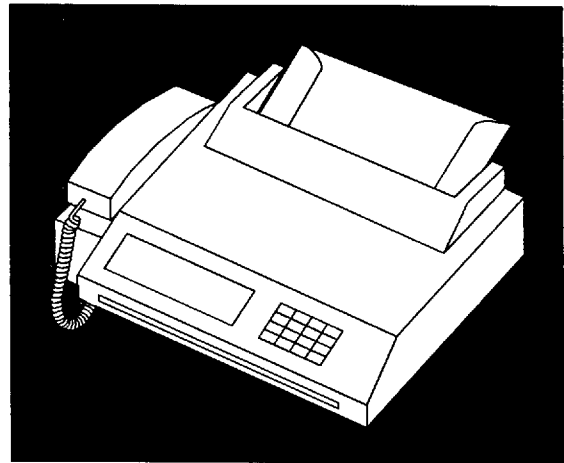

**Characteristics (examples)**

Item		Rated value			
Input	Input voltage	AC 100V/200V (AC 90~132V or AC 180~264V)			
	Frequency	50/60Hz (48~62Hz)			
	Inrush current	40Amax.			
	Efficiency	65%min.			
	Power factor	—			
Output	Channels	ch1	ch2	ch3	ch4
	Output voltage	+5.0V	+12.0V	-12.0V	+24.0V
	Rated current	0.6A	0.05A	0.05A	1.0A
	Current range	0.2~1.0A	0.01~0.1A	0.01~0.1A	5.0A
	Ripple/noise	200mV	300mV	300mV	700mV
	Overall regulation	±5%	±10%	±10%	±5%
	Overvoltage protection	—			
	Overcurrent protection	Short circuit protection			
Ambient conditions	Operating temp./humidity	0~+50°C, 10~90%RH (No dew deposit)			
	Non-operating temp./humidity	-20~+70°C, 0~95%RH (No dew deposit)			
	Vibration	2G, 10~55~10Hz/min., XYZ directions, 30 min. each			
	Shock	30G, 11ms, XYZ directions, 3 times each			
Construction, dimensions	Dimensions	60 × 175 × 39mm			
	Casing	Open frame			
	Thermal radiation	Natural cooling			
	Thermal protection	—			
Standards	Noise standards	VCCI class II, FCC-B, VDE-B			
	Safety standards	UL1950, IEC950, CSA C22.2 950, Denki Yohin (JAPAN)			



## ■ Customized switching power supplies for photocopiers

Intended for compact and medium to high-speed photocopiers, these switching power supplies have two output channels (+5V, +24V), a 160W rated power, and a 250W peak power. They provide 100V and 200V input voltage options.

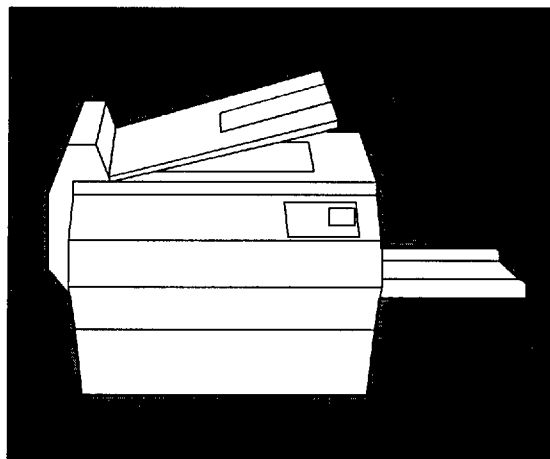

### Characteristics (examples)

Item		Rated value	
Input	Input voltage	AC 100V/200V (AC 85~138V or AC 187~276V)	
	Frequency	50/60Hz (45~65Hz)	
	Inrush current	50Amax.	
	Efficiency	70%min.	
	Power factor	—	
Output	Channels	ch1	ch2
	Output voltage	+5.0V	+24.0V
	Rated current	0.5A~1.5A	0.05A~6.5A
	Current range	0.5~2.0A	0.05~10A
	Ripple/noise	100mV	480mV
	Overall regulation	±5%	±10%
	Overvoltage protection	5.5~7.0V	27~33V
	Overcurrent protection	1.7~5.0A	10.1~15.0A
Ambient conditions	Operating temp./humidity	0~+55°C, 10~95%RH (No dew deposit)	
	Non-operating temp./humidity	-40~+70°C, 10~95%RH (No dew deposit)	
	Vibration	2mm amplitude, constant 16Hz, XYZ directions, 30 min. each	
	Shock	30G, 11msec, XYZ directions, 3 times each	
Construction, dimensions	Dimensions	100 × 240 × 50mm	
	Casing	Open frame	
	Thermal radiation	Natural cooling	
	Thermal protection	—	
Standards	Noise standards	VCCI class II, FCC-A, VDE-A	
	Safety standards	UL114, IEC950, CSA C22.2 950, Denki Yohin No. 8 (JAPAN)	

**Customized switching power supplies for control equipment**

We offer compact, highly reliable switching power supplies for programmable controllers. Input voltages come in 100V and 200V types, while their two-channel outputs are +5V and +24V (30W-2ch).

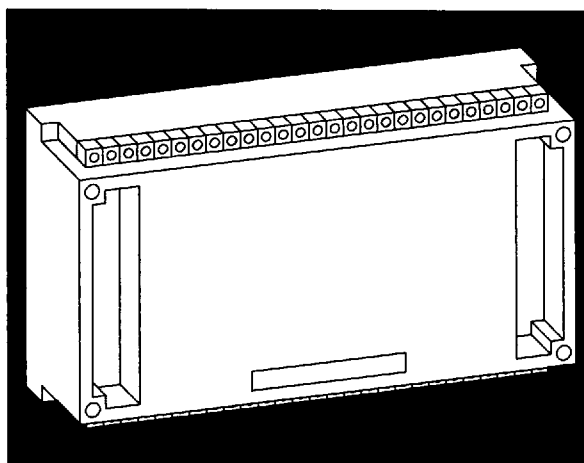

**Characteristics (examples)**

Item		Rated value	
Input	Input voltage	AC 100V/200V (AC 85~132V / AC 170~264V)	
	Frequency	50/60Hz (47Hz~63Hz)	
	Inrush current	20Amax.	
	Efficiency	65%	
Output	Channels	ch1	ch2
	Output voltage	+5.0V	+24.0V
	Rated current	3.0A	0.6A
	Current range	0~3.0A	0~0.6A
	Ripple/noise	200mVp-p	500mVp-p
	Overall regulation	±3%	±9%
	Overvoltage protection	5.5~6.5V	—
	Overcurrent protection	3.3~9.0A	0.66~1.88A
	Remote control	—	—
Ambient conditions	Operating temp./humidity	0~+55°C, 10~90%RH (No dew deposit)	
	Non-operating temp./humidity	-20~+80°C, 10~95%RH (No dew deposit)	
	Vibration	JIS C0911 10~55Hz 2G	
	Shock	JIS C0912 15G XYZ directions, 3 times each	
Construction, dimensions	Dimensions	88 × 125 × 47mm	
	Casing	Open frame	
	Thermal radiation	Natural cooling	
	Thermal protection	—	
Standards	Noise terminal voltage	FCC-A	
	Safety standards	UL508 CSA NO. 142/E.B.1402C	

**■ Plug-in AC adapters for note-sized PCs**

These plug-in AC adapters for note-sized PCs feature external dimensions that are identical with battery packs, so these adapters can be easily placed inside the PC body.

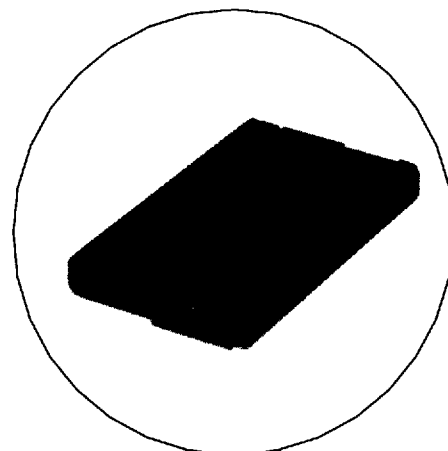

**Characteristics (examples)**

Item		Rated value	
Input	Input voltage	AC 100V/200V (AC 90~264V)	
	Frequency	50/60Hz (47~63Hz)	
	Inrush current	40Amax.	
	Efficiency	60%min.	
Output	Type	Type 1	Type 2
	Output voltage	DC+18V	DC+20V
	Rated current	1.7A	1.5A
	Current range	0~2.0A	0~1.8A
	Ripple/noise	180mVp-p	200mVp-p
	Overall regulation	±0.9V	±1V
	Overvoltage protection	-DC+24V	-DC+27V
	Overcurrent protection	-3.0A (Latch)	-2.7A (Latch)
Ambient conditions	Operating temp./humidity	0~+40°C, 10~90%RH (No dew deposit)	
	Non-operating temp./humidity	-20~+60°C, 0~95%RH (No dew deposit)	
	Vibration	5G, 10~55~10Hz/min., XYZ directions, 1 hr. each	
	Shock	75G, 11ms, XYZ directions, 3 times each	
Construction, dimensions	Dimensions	148.85 × 89 × 19.4mm	
	Casing	Plastic casing	
	Thermal radiation	Natural cooling	
	Thermal protection	—	
Standards	Noise standards	VCCI class II, FCC-B, VDE-B	
	Safety standards	UL1950, IEC950, CSA C22.2 950, Denki Yohin (JAPAN)	

**■ Super compact 50W AC adapters**

These plug-in adapters have achieved a remarkable 3.6cc/W miniaturization to realize the convenient use of notebook PCs and other portable electronic equipment.

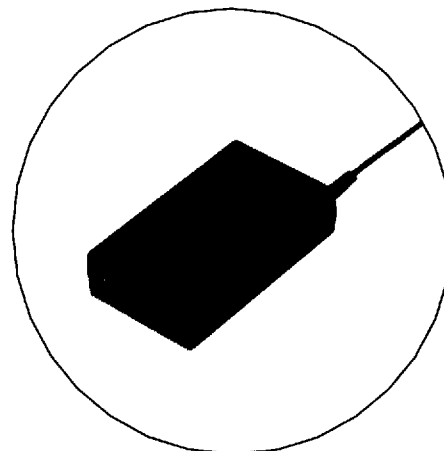

**Characteristics (examples)**

Item		Rated value
Input	Input voltage	AC 100V/200V (AC 90~264V)
	Frequency	50/60Hz (47~63Hz)
	Inrush current	30Amax. (100V) 60Amax. (200V)
	Efficiency	83%typ.
Output	Type	Type 1
	Output voltage	DC+16V
	Rated current	2.8A
	Current range	0~2.8A
	Ripple/noise	180mVp-p
	Overall regulation	+10% -5%
	Overvoltage protection	Provided (~DC+28V)
	Overcurrent protection	Provided (3.0A~)
Ambient conditions	Operating temp./humidity	0~+35°C, 10~90%RH (No dew deposit)
	Non-operating temp./humidity	-20~+60°C, 0~95%RH (No dew deposit)
	Vibration	5G, 10~55~10Hz/min., XYZ directions, 1 hr. each
	Shock	75G, 11ms, XYZ directions, 3 times each
Construction, dimensions	Dimensions	105 × 60 × 25.4mm
	Casing	Plastic casing
	Thermal radiation	Natural cooling
	Thermal protection	—
Standards	Noise standards	VCCI class II, FCC-B, CISPR22B, EN55022-B
	Safety standards	UL1950, IEC950, CSA C22.2 950, Denki Yohin - Kosyu (JAPAN)

**How to order customized switching power supplies**

FDK designs and manufactures customized switching power supplies on the basis of the specifications provided by the customer. When placing orders, please consider the following recommendations:

- ① We are willing to shorten the development period for you. Please feel free to discuss your schedule with us.
- ② In order to indicate the specifications you desire, please enter all information in the righthand table.
- ③ Please explain the intended aim of the switching power supplies you are looking for and the conditions under which they will be used.
- ④ If you have any questions or requests before placing an order, we welcome your early contact.

**Development steps**

Step	Flow chart	Customer	F D K	Ave. days Required
Engineering sample production	Inquiry	Prepare rough specifications and design requests		
	Consulting	Consultation on specifications		1 day
	Cost estimate	Draw up a circuit and parts plan, and produce a cost estimate: • Engineering sample cost • Mass product cost • Development cost	circuit & system design engineering sample evaluation PCB metal mold cost parts metal mold cost • Safety approval acquisition cost • Reliability evaluation cost	8 days
	Development scheduling	Decide specifications, development date, number of samples, mass production schedule, development cost, etc.		1 day
	Circuit design; System design		① Circuit design ② System design ③ Assembly plan ④ Parts selection ⑤ Parts list ⑥ Parts procurement	20 days
	Consultation on samples	Production of samples: • Engineering samples 1 • Engineering samples 2 • Pre-production samples		30 days
	Evaluation	Evaluation of actual operation in host equipment	Confirmation of characteristics, reliability, quality	60 days
	Final consultation	Finalize specifications in view of evaluation results		1 day
	Mass Production	Mass production		60 days from required

Note: The dates of engineering sample production, evaluation, and mass production sometimes overlap. Please check with our marketing division for exact schedules.

**Setting specifications**

Electrical characteristics	Rated output	Input voltage	<input type="checkbox"/> V ± <input type="checkbox"/> % (V)
		Frequency/phase	50/60 ± <input type="checkbox"/> Hz <input type="checkbox"/> ∅ Distortion factor <input type="checkbox"/> %
		Power consumption	<input type="checkbox"/> VAm <sub>ax</sub> . ( <input type="checkbox"/> V <input type="checkbox"/> Hz. rated load)
		Power factor	<input type="checkbox"/>
		Efficiency	<input type="checkbox"/> %min.
		Inrush current	<input type="checkbox"/> Am <sub>ax</sub> .
		Instantaneous shut time	1. None 2. <input type="checkbox"/> msec. ( <input type="checkbox"/> Hz) max.
		Output voltage	<input type="checkbox"/> V <input type="checkbox"/> V <input type="checkbox"/> V <input type="checkbox"/> V <input type="checkbox"/> V <input type="checkbox"/> V <input type="checkbox"/> V
		Output current	<input type="checkbox"/> A <input type="checkbox"/> A <input type="checkbox"/> A <input type="checkbox"/> A <input type="checkbox"/> A <input type="checkbox"/> A <input type="checkbox"/> A
		Voltage regulation	<input type="checkbox"/> % <input type="checkbox"/> % <input type="checkbox"/> % <input type="checkbox"/> % <input type="checkbox"/> % <input type="checkbox"/> % <input type="checkbox"/> %
		Voltage variable range	<input type="checkbox"/> % <input type="checkbox"/> % <input type="checkbox"/> % <input type="checkbox"/> % <input type="checkbox"/> % <input type="checkbox"/> % <input type="checkbox"/> %
		Ripple/noise voltage	<input type="checkbox"/> V <input type="checkbox"/> V <input type="checkbox"/> V <input type="checkbox"/> V <input type="checkbox"/> V <input type="checkbox"/> V <input type="checkbox"/> V
		Spike noise voltage	<input type="checkbox"/> V <input type="checkbox"/> V <input type="checkbox"/> V <input type="checkbox"/> V <input type="checkbox"/> V <input type="checkbox"/> V <input type="checkbox"/> V
		Total variation	<input type="checkbox"/> % <input type="checkbox"/> % <input type="checkbox"/> % <input type="checkbox"/> % <input type="checkbox"/> % <input type="checkbox"/> % <input type="checkbox"/> %
		Over shoot	<input type="checkbox"/> % <input type="checkbox"/> % <input type="checkbox"/> % <input type="checkbox"/> % <input type="checkbox"/> % <input type="checkbox"/> % <input type="checkbox"/> %
Protection	Overvoltage protection		
	Overcurrent protection		
	Thermal protection		
Added function	Remote sensing		
	Output sequence		
	Remote control	1. None 2. As per attached paper	
Isolation	Blackout sensing signal	1. None 2. As per attached paper	
	Withstand voltage	<input type="checkbox"/> V AC/DC 1 min.	
	Isolation resistance	V DC <input type="checkbox"/> MΩmin. at leak current <input type="checkbox"/> mA max.	
Noise	External noise resistance	Pulse width <input type="checkbox"/> ns, Peak value <input type="checkbox"/> V	
	Audible noise	<input type="checkbox"/> dB max. <input type="checkbox"/> m distance	
Ambience	Operating temp./humidity	<input type="checkbox"/> °C~ <input type="checkbox"/> °C/ <input type="checkbox"/> %~→ <input type="checkbox"/> %RH	
	Non-operating temp./humidity	<input type="checkbox"/> °C~ <input type="checkbox"/> °C/ <input type="checkbox"/> %~→ <input type="checkbox"/> %RH	
	Temperature rise	<input type="checkbox"/> °C max.	
Anti-vibration	Cooling method	1. Natural cooling 2. Forced cooling Wind direction, volume <input type="checkbox"/> ℓ/min.	
	Vibration resistance	<input type="checkbox"/> Hz~ <input type="checkbox"/> Hz <input type="checkbox"/> G/mm <input type="checkbox"/> hr.	
	Shock resistance	<input type="checkbox"/> m sec. <input type="checkbox"/> G <input type="checkbox"/> times	
Construction	Surface treatment		
	Weight	<input type="checkbox"/> kg max.	
	Dimensions	Mainframe <input type="checkbox"/> cm × <input type="checkbox"/> cm × <input type="checkbox"/> cm	
	Installation area/position		
Load	Safety regulation		
	Casing	With casing, Open frame	
	Load electrostatic capacity		
Reliability	No-load excitation		
	Derating		
	MTBF/MTTR		
Other	Noise regulation	VCCI I/II, FCC A/B, VDE A/B	
	Applications		
	Nos. of samples/mass products		
	Date of mass production		

# Customized DC-DC converters

## ■ Customized DC-DC converters for microprocessors

These onboard DC-DC converters designed for microprocessors have been remarkably downsized through the use of metallic circuit boards. They feature a free choice of a precise output voltage in the 4.7-5.3V range by attaching an external resistor.

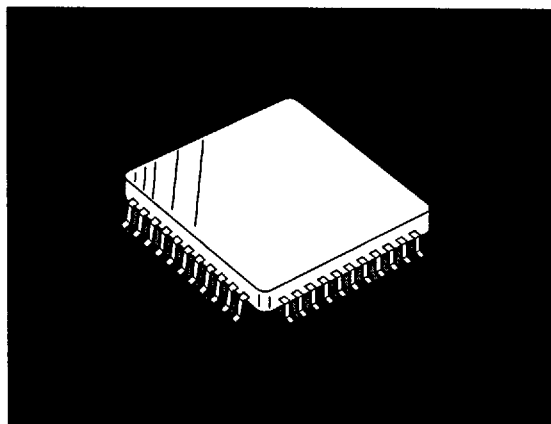

### Characteristics (examples)

Item		Rated value
Input	Input voltage	DC+5.0V (DC+4.75V~DC5.25V)
	Inrush current	—
	Efficiency	80% min (with rated input)
	Input current	5.5Amax. ( *)
Output	Channels	ch 1
	Output voltage	+4.7V~+5.3V variable (using an external resistor)
	Permissible output	22wmax.
	Permissible current range	1.0~4.5A
	Ripple/noise	50mv/150mV p-p
	Output voltage regulation	±50mV
	Overvoltage protection	+5.7~6.5V
	Overcurrent protection	Short circuit protection
	Rise time	100msec. or less
	Remote ON/OFF	—
Ambient conditions	Operating temp./humidity	0~+45°C, 5~95%RH (No dew deposit)
	Non-operating temp./humidity	-40~+75°C, 0~95%RH (No dew deposit)
	Vibration	5G, 5~500~5Hz/min., XYZ directions, 10 min. each
	Shock	50G, 11ms, XYZ directions, 3 times each
Construction, dimensions	Dimensions	72 × 25.4 × 12.7mm
	Construction	Open frame
	Thermal radiation	Forced air cooling (conditions specified separately)
	Connection method	Lead frame (flow-soldering)

## ■ Customized DC-DC converters for switchboards

These onboard DC-DC converters for switchboards feature compatibility with plug-in cards and an impressively compact size through the use of metallic circuit boards. Their input voltage is 48V, while their output is either 5V or 3.3V with a 8.0A current.

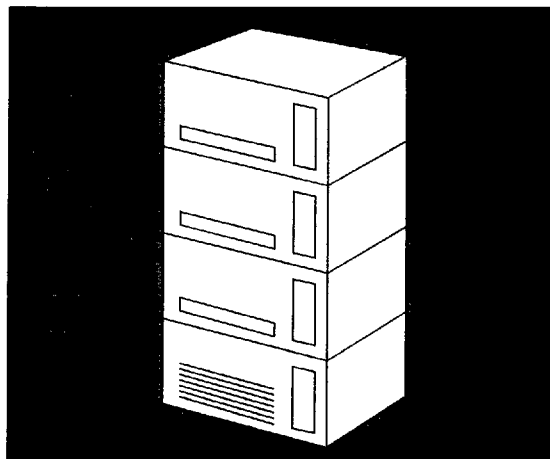

### Characteristics (examples)

Item		Rated value
Input	Input voltage	DC+48V (DC+38.4~72V)
	Inrush current	—
	Efficiency	75%min.
	Input current	0.86
Output	Channels	ch 1
	Output voltage	5V or 3.3V
	Rated current	7.5A
	Current range	0~7.5A
	Ripple/noise	50mV/120mVP-P
	Total variation	±5%
	Overvoltage protection	3.8~4.6V (shut down)
	Overcurrent protection	8.5~11.0A (self-resumption)
	Rise time	—
	Isolation withstand voltage	Input-to-output, DC500V, 60 sec.
Ambient conditions	Operating temp./humidity	0~+70°C, 10~90%RH (No dew deposit)
	Non-operating temp./humidity	-40~+70°C, 0~95%RH (No dew deposit)
	Vibration	5G, 5~500~5Hz/min., XYZ directions, 10 min. each
	Shock	50G, 11ms, XYZ directions, 3 times each
Construction, dimensions	Dimensions	56.5 × 55.9 × 13.0mm
	Construction	Open frame
	Thermal radiation	Forced air cooling (90m/min.)
	Connection method	Lead frame (flow-soldering)

**Customized DC-DC converters for notebook PCs**

Intended for use in notebook PCs, these DC-DC converters provide a constant output current for recharging the PC's batteries. A constant output voltage is supplied by the main superb 90% efficiency rating, thus ensuring stable PC operation by battery power.

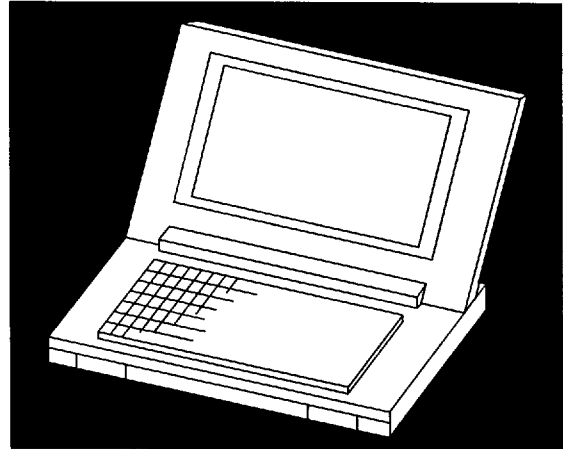

**Characteristics (examples)**

Item		Rated value					
Input	Input voltage	DC+7.2V (DC+6.0~+17.0V)			DC+3.6V (DC+2.7~+4.2V)		DC15V
	Efficiency (type load)	90%min.			60%min.		70%min.
	Input current	2.7A (type input, type load) min.			—		—
Output	Output current	Constant voltage output (main)			Constant voltage output (sub)		Constant current output
	Channels	ch1	ch2	ch3	ch4	ch5	ch6
	Output voltage	+5.0V	+3.3V	+12V	+5.0V	+3.3V	5~10V
	Rated current	0.6A	0.65A	0.05A	0.01A	0.001A	0.35A
	Current range	0.003~2.0A	0.005~2.0A	0.0001~0.06A	0.003~0.015A	—	0.32~0.38A
	Ripple	100mVp-p	100mVp-p	100mVp-p	100mVp-p	100mVp-p	100mVp-p
	Total variation	±0.25V	±0.2V	±0.6V	±0.3V	±0.3V	—
	Oversvoltage protection	~6.5V	~4.5V	~14.0V	—	—	—
	Overcurrent protection	Short circuit protection	Short circuit protection	Short circuit protection	—	—	Short circuit protection
	Rise time	15ms	15ms	50ms	10ms	10ms	—
	Remote ON/OFF	Provided	Provided	Provided	—	—	Provided
	Ambient conditions	Operating temp./humidity	0~+50°C, 10~80%RH (No dew deposit)				
Non-operating temp./humidity		-20~+70°C, 0~95%RH (No dew deposit)					
Vibration		0.5G, 10~100~10Hz/min. XYZ directions, 10 min. each					
Shock		50G, 11ms, XYZ directions, 3 times each					
Construction, dimensions	Dimensions	80 × 48 × 14mm					
	Construction	Open frame					
	Thermal radiation	Forced air cooling					
	Connection method	Lead frame (flow or manual soldering)					



**General-purpose compact DC-DC converters (MX Series)**

These DC-DC converters, which are very flat with a height of only 8.5mm, are packed inside metallic casing in order to prevent radiation noise from affecting the surrounding components. Their floating input-output system allows both single- and dual-output options, and are usable without attaching any external components.

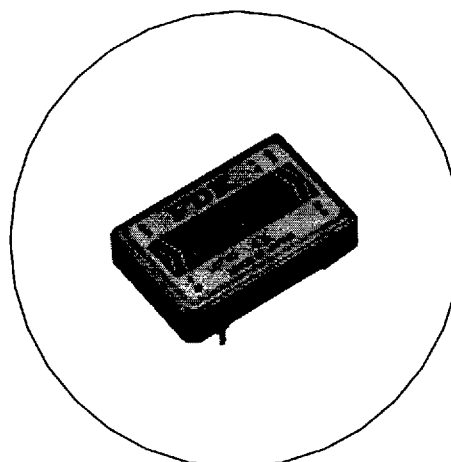

**Characteristics (examples)**

Model No.	MX0505S250	MX0506S210	MX0512S120	MX0509S150	MX0505F100	MX0512F060	MX0515F050	MX1205S300	MX2405S300	MX4805S300
Input voltage	DC4.5V~6.0V							DC10.0V-16.0V	DC20.0V-30.0V	DC36.0V-56.0V
Output voltage	5V	6V	12V	9V	±5V	±12V	±15V	5V	5V	5V
Overall regulation	±5%	±5%	±5%	±5%	±5% each	±5% each	±5% each	±5%	±5%	±5%
Output current	0-250mA	0-210mA	0-120mA	0-150mA	0-100mA	(0-60) mA × 2	(0-50) mA × 2	0-300mA	0-300mA	0-300mA
Output capacity	1.25W	1.25W	1.44W	1.35W	1.00W	1.44W	1.5W	1.5W	1.5W	1.5W
Ripple/noise	120mVp-p	120mVp-p	120mVp-p	120mVp-p	120mVp-p	120mVp-p	120mVp-p	120mVp-p	120mVp-p	120mVp-p
Overcurrent protection	Short protection (self-resumption)									
Efficiency (Typ. input, Max. load)	62%				45%	62%		70%		
Isolation	Primary-to-secondary, AC 500V, 1 min.									
Shielding	Metallic casing, five-surface shielding									
Operating temperature	-10°C~+70°C (see the derating curve for 50°C or over)									
Non-operating temp.	-20°C~+85°C									
Humidity	95%max. (MAX wet-bulb temp. 38°C)									
Dimensions	33 × 22 × 8.5									
Vibration	10Hz~56.7Hz Vibration 1.5mmP-P					} No abnormality after 1 min. intermittent vibrations for 2 hr. in each of XYZ directions				
	56.8Hz~350Hz 10G									
	351Hz~500Hz 2G									
Shock	100G, 6msec, XYZ directions, 3 times each									
Weight	15g									

Made to order

**Derating curve**

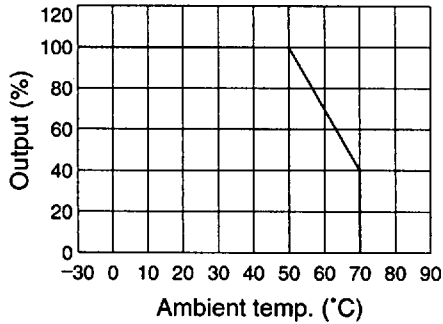

**Precautions**

1. The ripple and noise contained in the input voltage must not exceed +1%p-p of the rated input voltage.
2. Do not connect the output of the DC-DC converters in parallel to boost the output current or for any other purpose.
3. Because these DC-DC converters are packed in metallic casings, they should be insulated from the surrounding components and patterns.
4. We recommend that our customers install a protective fuse in the input line of their equipment.

**Connection diagram**

(1) Single-output type

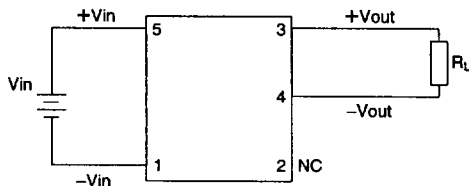

(2) Dual-output type

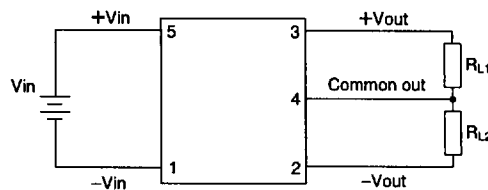

**Shape and dimensions**

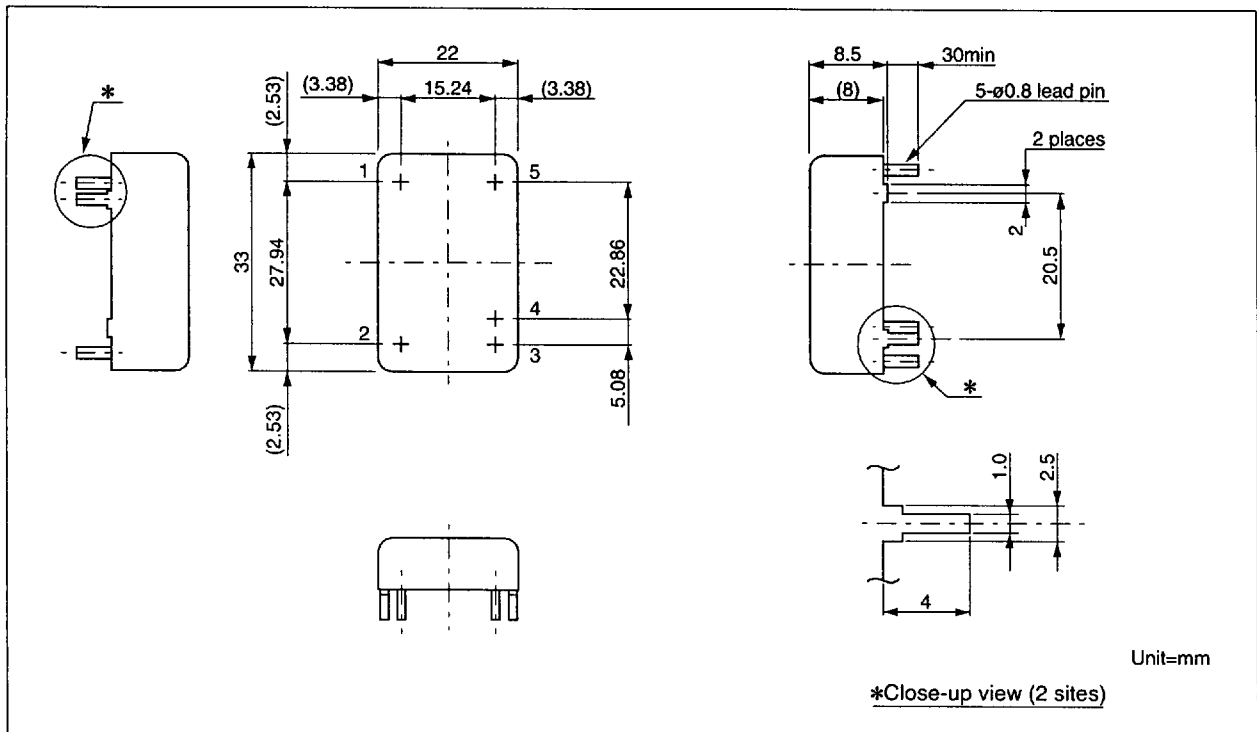

## How to order customized DC-DC converters

FDK always stand ready to receive orders for custom-design DC-DC converters. When placing orders, please enter your desired design in the specification table below.

### Setting specifications

Electrical characteristics	Rated output	Input voltage	<input type="checkbox"/> V ± <input type="checkbox"/> % (V)						
		Efficiency	<input type="checkbox"/> %min.						
		Output voltage	<input type="checkbox"/> V	<input type="checkbox"/> V	<input type="checkbox"/> V	<input type="checkbox"/> V	<input type="checkbox"/> V	<input type="checkbox"/> V	<input type="checkbox"/> V
		Output current	<input type="checkbox"/> A	<input type="checkbox"/> A	<input type="checkbox"/> A	<input type="checkbox"/> A	<input type="checkbox"/> A	<input type="checkbox"/> A	<input type="checkbox"/> A
		Voltage regulation	<input type="checkbox"/> %	<input type="checkbox"/> %	<input type="checkbox"/> %	<input type="checkbox"/> %	<input type="checkbox"/> %	<input type="checkbox"/> %	<input type="checkbox"/> %
		Voltage variable range	<input type="checkbox"/> %	<input type="checkbox"/> %	<input type="checkbox"/> %	<input type="checkbox"/> %	<input type="checkbox"/> %	<input type="checkbox"/> %	<input type="checkbox"/> %
		Ripple/noise voltage	<input type="checkbox"/> V	<input type="checkbox"/> V	<input type="checkbox"/> V	<input type="checkbox"/> V	<input type="checkbox"/> V	<input type="checkbox"/> V	<input type="checkbox"/> V
	Spike noise voltage	<input type="checkbox"/> V	<input type="checkbox"/> V	<input type="checkbox"/> V	<input type="checkbox"/> V	<input type="checkbox"/> V	<input type="checkbox"/> V	<input type="checkbox"/> V	
	Protection	Overvoltage protection							
		Overcurrent protection							
Added function	Output sequence								
	Remote control	1. None 2. As per attached paper							
Isolation	Withstand voltage	<input type="checkbox"/> V AC/DC, 1 min.							
	Isolation resistance	V DC <input type="checkbox"/> MΩmin. at leak current <input type="checkbox"/> mA max.							
Ambience	Operating temp./humidity	<input type="checkbox"/> °C~ <input type="checkbox"/> °C/ <input type="checkbox"/> %~→ <input type="checkbox"/> %RH							
	Non-operating temp./humidity	<input type="checkbox"/> °C~ <input type="checkbox"/> °C/ <input type="checkbox"/> %~→ <input type="checkbox"/> %RH							
	Cooling Method	1. Natural Cooling      Window direction 2. Forced cooling      Wind volume <input type="checkbox"/> ℓ /min.							
Anti-vibration	Vibration	<input type="checkbox"/> Hz~ <input type="checkbox"/> Hz, <input type="checkbox"/> G/mm, <input type="checkbox"/> hr.							
	Shock	<input type="checkbox"/> m sec., <input type="checkbox"/> G, <input type="checkbox"/> times							
Construction	Weight	<input type="checkbox"/> kg max.							
	Dimensions	<input type="checkbox"/> cm × <input type="checkbox"/> cm × <input type="checkbox"/> cm							
	Installation area/position								
	Casing	Encased, None							
	Casing material								
Other	Applications								
	Nos. of samples/mass products								
	Date of mass production								

\* Please feel free to consult us for delivery of DC-DC converters in a very short period.

## Precautions Before Use

---

Switching power supplies and DC-DC converters are designed generally as components to be incorporated into equipment. FDK therefore recommends the use of its power supplies and DC-DC converters as components to be safely installed in relation to other components inside the host equipment.

### ● Safety

1. Rated input voltage      A suitable input voltage range is designated for each model.  
To prevent breakdown and other hazards, do not apply a voltage outside this range to power supplies and DC-DC converters; also, do not apply an inverse voltage to DC-DC converters.
2. Leakage current      A leakage current within a designated safety limit flows in each power supply. When more than one power supplies are used in the same system, their leakage currents are added on. The combined leakage current must not exceed safety levels.
3. Grounding      To prevent electric shocks and noise interferences, connect the grounding terminal of the switching power supply or DC-DC converter with the host equipment body, using a thick and short wire.
4. Wiring      For the wiring of the switching power supply in the host equipment, use thick wires that match the rated input and output currents of the power supply.
5. When the fuse has blown      In most cases, the blowing of the fuse is accompanied by the breakdown of an internal circuit. Because just replacing the fuse will not be sufficient, contact FDK for repair.
6. Watch out for high voltage      Each switching power supply has high-voltage areas inside. To avoid an electric shock, do not touch it by bare hand.

### ● Operating environment

7. Temperature      The service life of a power supply varies widely according to its ambient temperature. For a longer life, keep the temperature inside the host equipment as low as possible. Users who operate power supplies continuously for a long time are advised to overhaul their power supplies at intervals.
8. Water and humidity      To prevent the breakdown of a circuit inside the power supply, do not operate in an environment where the power supply is liable to be wetted by splash water or by dew.
9. Dust      The use of a power supply or a DC-DC converter often results in the breakdown of the fan and/or the shorting of an internal circuit. For operation in a dusty environment, take a dust blocking step.
10. Vibration and shock      In case of using a power supply or a DC-DC converter in an environment with continual vibrations and physical shocks, take an impact absorbing step.



## **FDK CORPORATION**

### **International Div. Office**

6-1-11, Shinbashi, Minato-ku, Tokyo 105-0004, Japan (Shuwaonarimon Bldg.)  
TEL: (81)-3-3434-1018 FAX: (81)-3-3431-9436

### **U.S.A. FDK AMERICA, INC. CORPORATE OFFICE**

2270 North First Street, San Jose, California 95131, U.S.A.  
TEL: (1)-408-432-8331 FAX: (1)-408-435-7478

### **FDK AMERICA, INC. BOSTON OFFICE**

404 Wyman Street, Suite 300, Waltham, Massachusetts 02154, U.S.A.  
TEL: (1)-781-487-3198 FAX: (1)-781-487-3199

### **FDK AMERICA, INC. DALLAS OFFICE**

Los Colinas Executive Suites 320 Decker Drive, Suite 140 Irving,  
Texas 75062, U.S.A.

TEL: (1)-972-719-2536 FAX: (1)-972-719-2591

### **FDK AMERICA, INC. SAN DIEGO OFFICE**

6540 Lusk Blvd Suite C263 San Diego,  
California 92121, U.S.A.

TEL: (1)-619-558-8368 FAX: (1)-619-558-6005

### **Europe FDK ELECTRONICS GMBH**

Hansaallee 177C, 40549 Düsseldorf, Germany  
TEL: (49)-211-591574 FAX: (49)-211-593549

### **Asia FDK HONG KONG LTD.**

Unit 18, 15/F., Chevalier Commercial Centre, 8 Wang Hoi Road,  
Kowloon Bay, Hong Kong  
TEL: (852)-27999773 FAX: (852)-27554635

### **FDK SINGAPORE PTE., LTD.**

4, Leng Kee Road, #06-07/08 SiS Building, Singapore. 159088,  
Republic of Singapore  
TEL: (65)-472-2328 FAX: (65)-472-5761