

GaAs IC 4 Bit Digital Attenuator

2 dB LSB Positive Control 0.5–2 GHz



AA264-87

Features

- Attenuation 2 dB Steps to 30 dB with High Accuracy
- Single Positive Control for Each Bit
- Low DC Power Consumption
- Small Low Cost TSSOP-16 Plastic Package

Description

The AA264-87 is a 4 bit, single positive control GaAs IC FET digital attenuator in a low cost TSSOP-16 package. The attenuator requires external DC blocking capacitors, positive supply voltage (V_S) and four individual positive control voltages (V_1 – V_4). The AA264-87 is particularly suited where high attenuation accuracy, low insertion loss and low intermodulation products are required. Typical applications include base station, wireless data and wireless local loop gain control circuits.

TSSOP-16

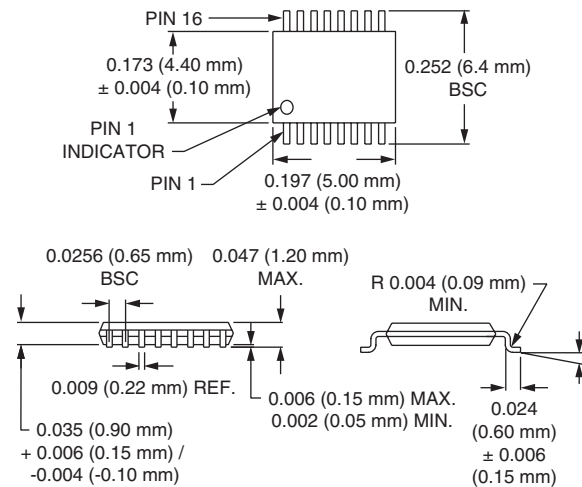

Electrical Specifications at -40°C to +85°C (0, +5 V)

Parameter ¹	Condition	Frequency	Min.	Typ.	Max.	Unit
Insertion Loss		0.5–1.0 GHz		1.6	2.0	dB
		0.5–2.0 GHz		1.8	2.4	dB
Attenuation Range				30		dB
Attenuation Accuracy ²		0.5–1.0 GHz	± (0.2 + 3% of Attenuation Setting in dB)			dB
		0.5–2.0 GHz	± (0.3 + 5% of 2–24 dB Setting)			dB
		0.5–2.0 GHz	± (0.3 + 6% of 26–30 dB Setting)			dB
VSWR (I/O) ³		0.5–0.8 GHz		1.8:1	2.2:1	
		0.8–2.0 GHz		1.5:1	2.0:1	
Switching Characteristics ⁴	Rise, Fall (10/90% or 90/10% RF) On, Off (50% CTL to 90/10% RF) Video Feedthru			150		ns
				300		ns
				70		mV
Input Power for 1 dB Compression	$V_S = +3$ V	0.5–2.0 GHz	+15	+21		dBm
	$V_S = +5$ V	0.5–2.0 GHz	+21	+27		dBm
Intermodulation Intercept Point (IP3)	For Two-tone Input Power +5 dBm $V_S = +3$ V $V_S = +5$ V	0.5–2.0 GHz	+36	+44		dBm
		0.5–2.0 GHz	+37	+45		dBm
Control Voltages	$V_{Low} = 0$ to 0.2 V @ 20 μ A Max. $V_{High} = +3$ V @ 100 μ A Max. to +5 V @ 200 μ A Max. $V_S = V_{High} \pm 0.2$ V					

1. All measurements made in a 50 Ω system, unless otherwise specified.
2. Attenuation referenced to insertion loss.

3. Input/output.
4. Video feedthru measured with 1 ns risetime pulse and 500 MHz bandwidth.

Typical Performance Data (0, +5 V)

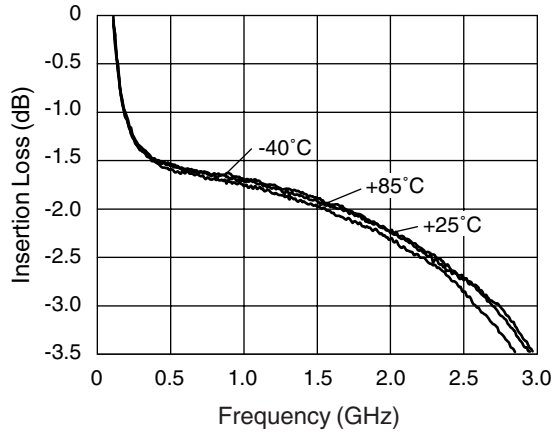

Insertion Loss vs. Frequency

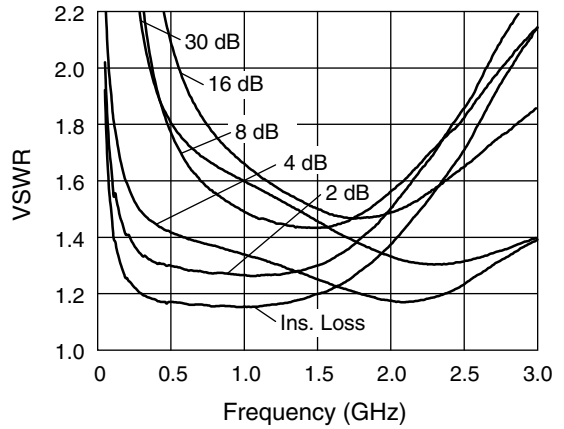

VSWR vs. Frequency (25°C)

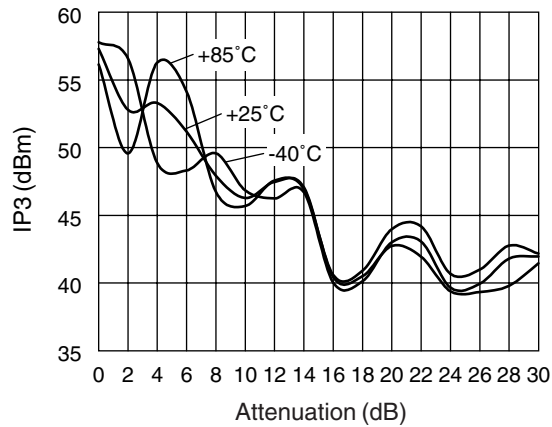

IP3 vs. Attenuation and Temperature (500 MHz)

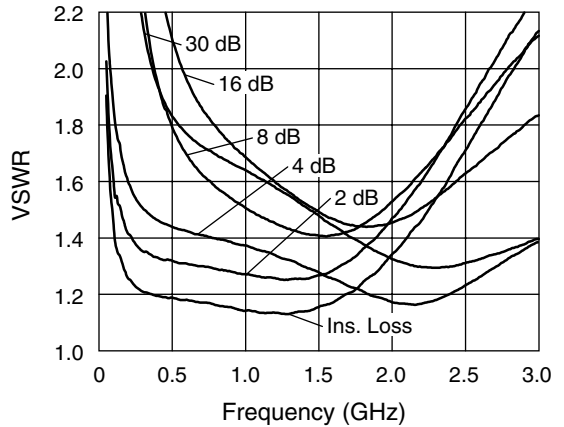

VSWR vs. Frequency (85°C)

Compression Point vs. Attenuation, Voltage, and Temperature

Attenuation State	Control Voltage (V)	Input Power @ 1 dB Compression		
		+25°C (dBm)	+85°C (dBm)	-40°C (dBm)
Ins. Loss	5	29.0	28.9	29.0
2 dB	5	28.3	28.1	28.1
4 dB	5	35.2	34.7	35.0
8 dB	5	25.8	25.3	25.4
16 dB	5	21.7	21.3	21.6
30 dB	5	24.4	23.2	27.2

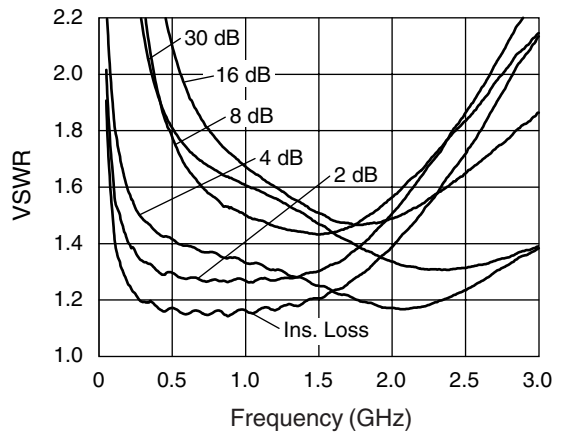

VSWR vs. Frequency (-40°C)

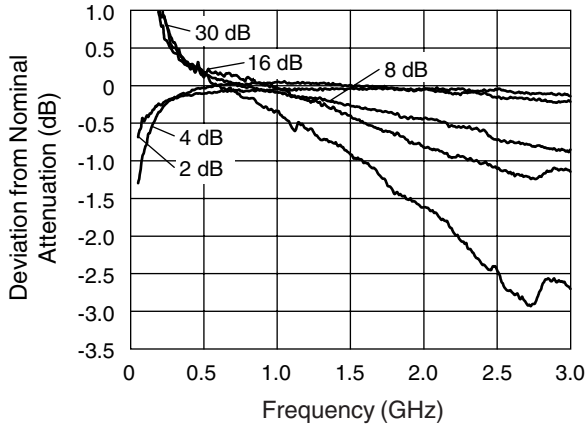

Attenuation Accuracy vs. Frequency (25°C)

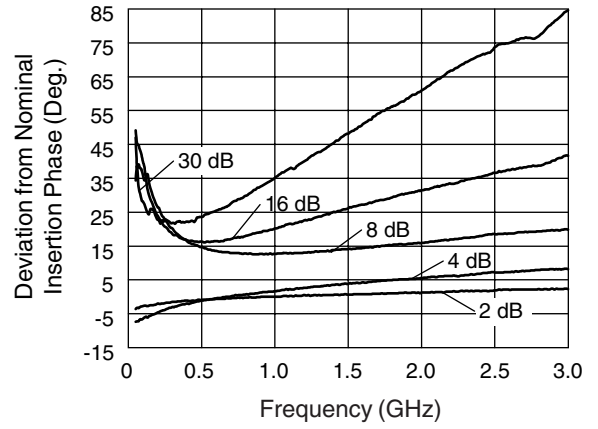

Attenuation Phase Accuracy vs. Frequency (25°C)

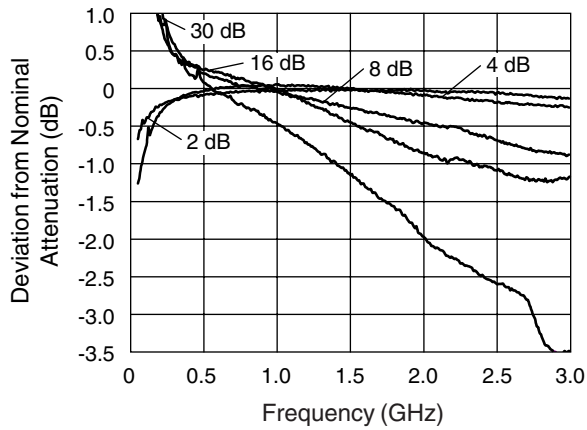

Attenuation Accuracy vs. Frequency (85°C)

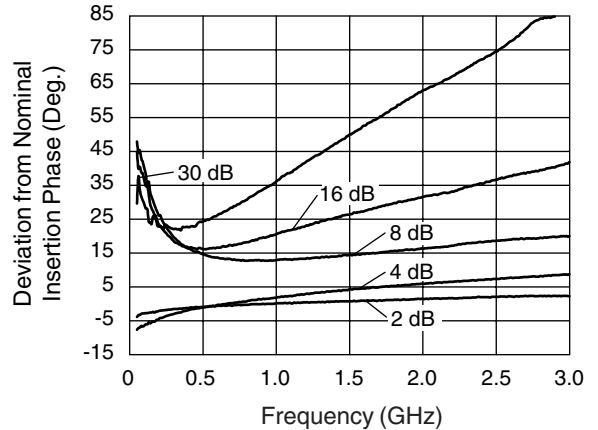

Attenuation Phase Accuracy vs. Frequency (85°C)

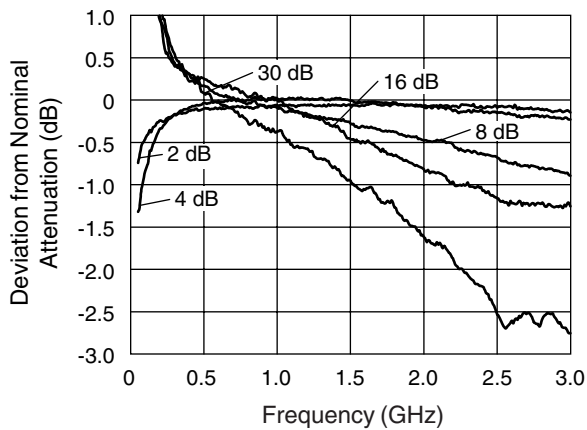

Attenuation Accuracy vs. Frequency (-40°C)

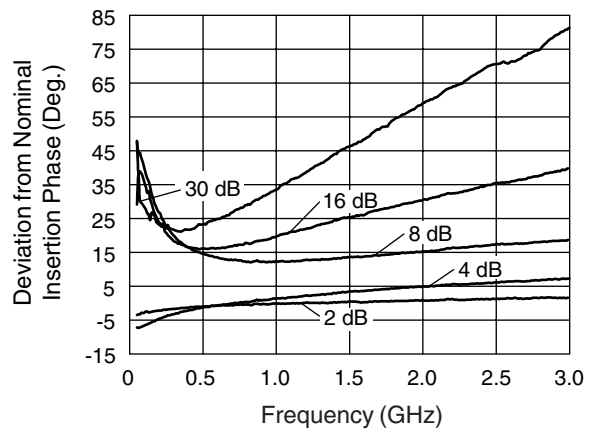

Attenuation Phase Accuracy vs. Frequency (-40°C)

Typical Performance Data (0, +3 V)

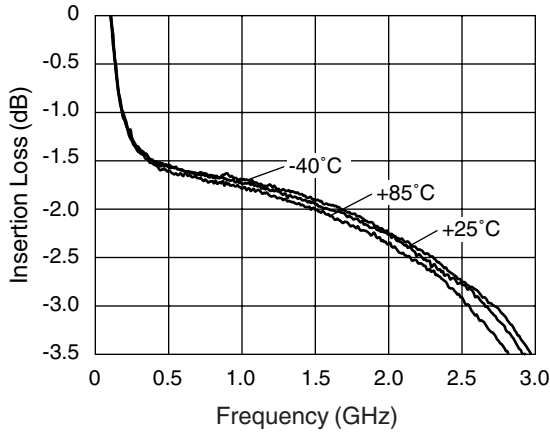

Insertion Loss vs. Frequency

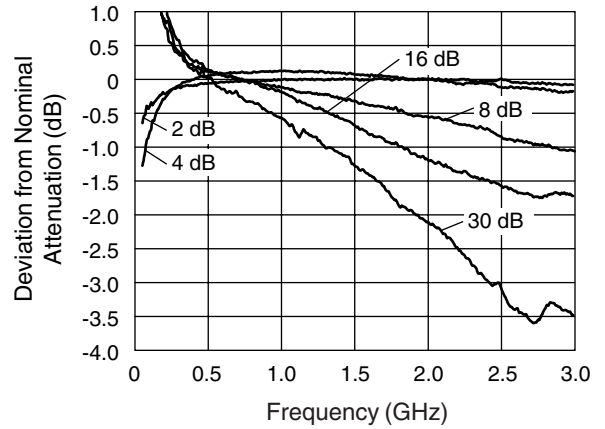

Attenuation Accuracy vs. Frequency (25°C)

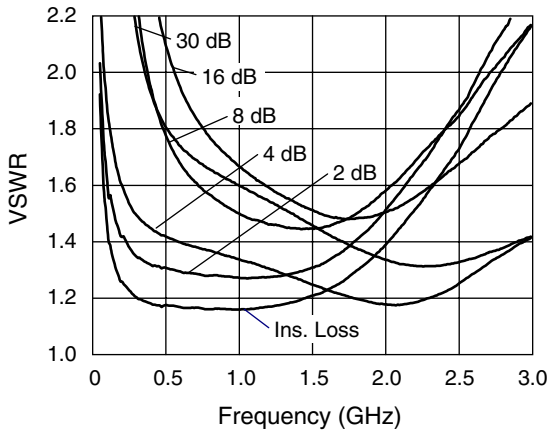

VSWR vs. Frequency (25°C)

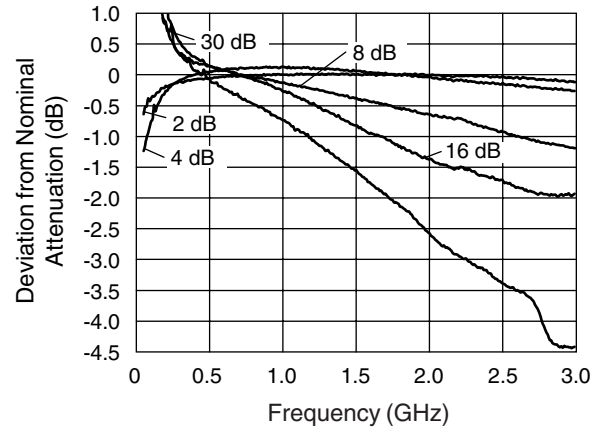

Attenuation Accuracy vs. Frequency (85°C)

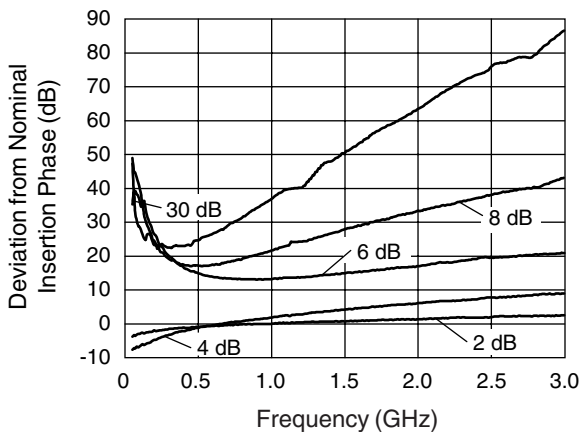

Attenuation Phase Accuracy vs. Frequency (25°C)

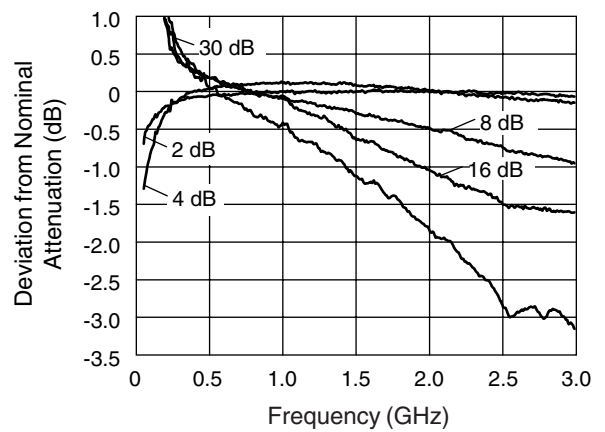

Attenuation Accuracy vs. Frequency (-40°C)

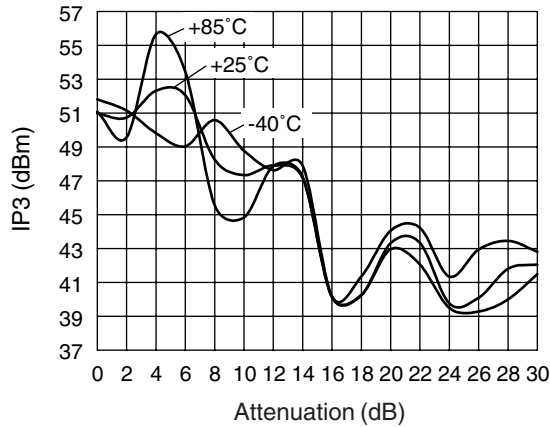

IP3 vs. Attenuation and Temperature (500 MHz)

Compression Point vs. Attenuation, Voltage, and Temperature

Attenuation State	Control Voltage (V)	Input Power @ 1 dB Compression		
		+25°C (dBm)	+85°C (dBm)	-40°C (dBm)
Ins. Loss	3	21.7	21.6	22.6
2 dB	3	21.2	20.7	21.4
4 dB	3	34.3	31.0	34.3
8 dB	3	33.6	23.0	32.9
16 dB	3	18.0	17.0	21.4
30 dB	3	22.4	21.2	24.1

Truth Table

V ₁	V ₂	V ₃	V ₄	Attenuation
16 dB	8 dB	4 dB	2 dB	J ₁ –J ₂
V _{High}	V _{High}	V _{High}	V _{High}	Reference I.L.
V _{High}	V _{High}	V _{High}	0	2 dB
V _{High}	V _{High}	0	V _{High}	4 dB
V _{High}	0	V _{High}	V _{High}	8 dB
0	V _{High}	V _{High}	V _{High}	16 dB
0	0	0	0	30 dB Max. Atten.

V_{High} = +3 to +5 V (V_S = V_{High} ± 0.2 V).

Absolute Maximum Ratings

Characteristic	Value
RF Input Power	1 W > 500 MHz 0/8 V 0.5 W @ 50 MHz 0/8 V
Supply Voltage	+8 V
Control Voltage	-0.2 V, +8 V
Operating Temperature	-40°C to +85°C
Storage Temperature	-65°C to +150°C

Note: Exceeding these parameters may cause irreversible damage.

Pin Out

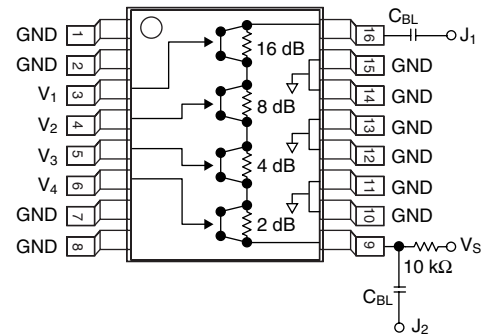

DC blocking capacitors (C_{BL}) and biasing resistor must be supplied externally for positive voltage operation.
C_{BL} = 47 pF for operation >500 MHz.

This datasheet has been download from:

www.datasheetcatalog.com

Datasheets for electronics components.