

Dual octal transceiver/registers, non-inverting (3-State)

MB2652

FEATURES

- Independent registers for A and B buses
- Multiple V_{CC} and GND pins minimize switching noise
- Live insertion/extraction permitted
- Power-up 3-State
- Power-up reset
- Multiplexed real-time and stored data
- Output capability: +64mA/-32mA

- Latch-up protection exceeds 500mA per Jedec JC40.2 Std 17
- ESD protection exceeds 2000V per MIL STD 883 Method 3015 and 200V per Machine Model

power dissipation with high speed and high output drive.

The MB2652 transceiver/register consists of two sets of bus transceiver circuits with 3-State outputs, D-type flip-flops, and control circuitry arranged for multiplexed transmission of data directly from the input bus or the internal registers. Data on the A or B bus will be clocked into the registers as the appropriate clock pin goes High. Output Enable (\overline{nOEAB} , \overline{nOEBA}) and Select (\overline{nSAB} , \overline{nSBA}) pins are provided for bus management.

DESCRIPTION

The MB2652 high-performance BiCMOS device combines low static and dynamic

QUICK REFERENCE DATA

SYMBOL	PARAMETER	CONDITIONS $T_{amb} = 25^{\circ}C$; $GND = 0V$	TYPICAL	UNIT
t_{PLH} t_{PHL}	Propagation delay nAx to nBx	$C_L = 50pF$; $V_{CC} = 5V$	3.3	ns
C_{IN}	Input capacitance	$V_I = 0V$ or V_{CC}	4	pF
$C_{I/O}$	I/O capacitance	$V_O = 0V$ or V_{CC} ; 3-State	7	pF
I_{CCZ}	Total supply current	Outputs disabled; $V_{CC} = 5.5V$	120	μA

ORDERING INFORMATION

PACKAGES	TEMPERATURE RANGE	ORDER CODE	DRAWING NUMBER
52-pin plastic Quad Flat Pack (QFP)	$-40^{\circ}C$ to $+85^{\circ}C$	MB2652BB	1418B

PIN CONFIGURATION

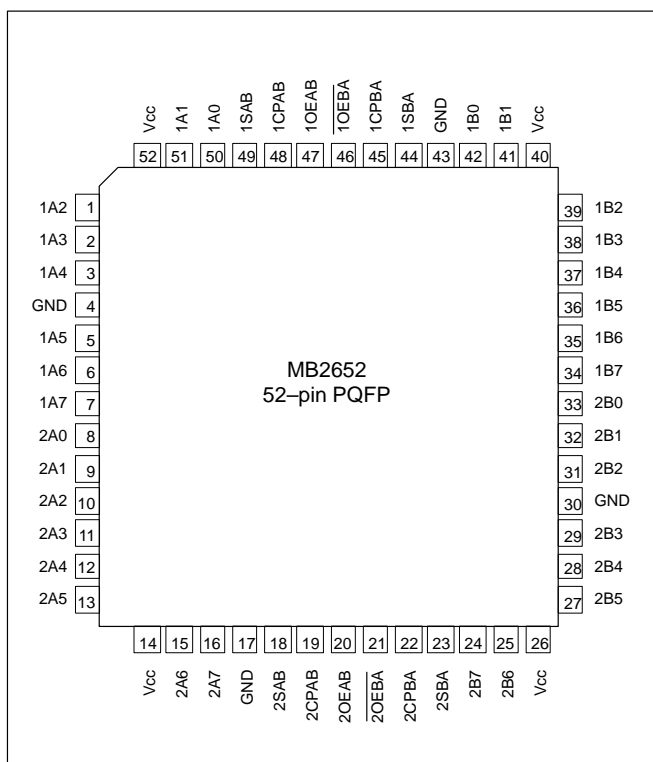

LOGIC SYMBOL

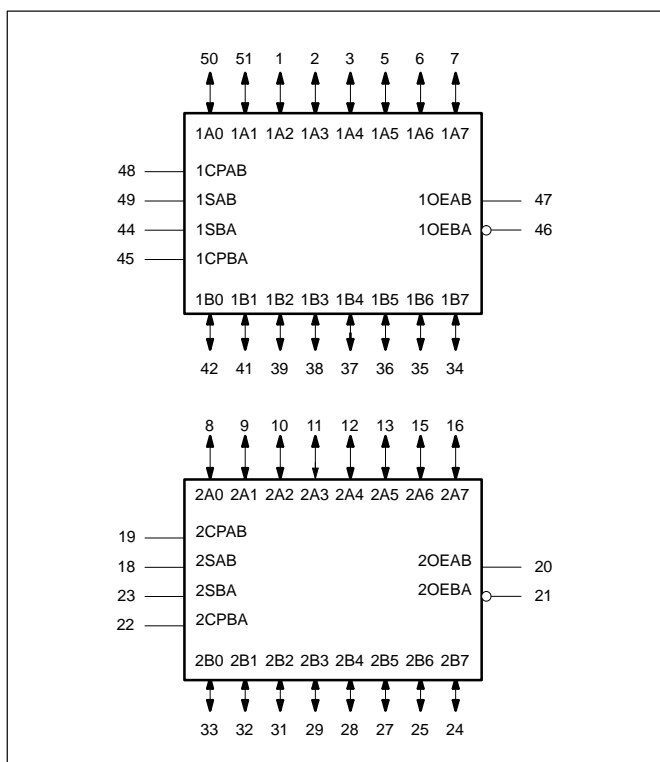

Dual octal transceiver/registers, non-inverting (3-State)

MB2652

LOGIC SYMBOL (IEEE/IEC)

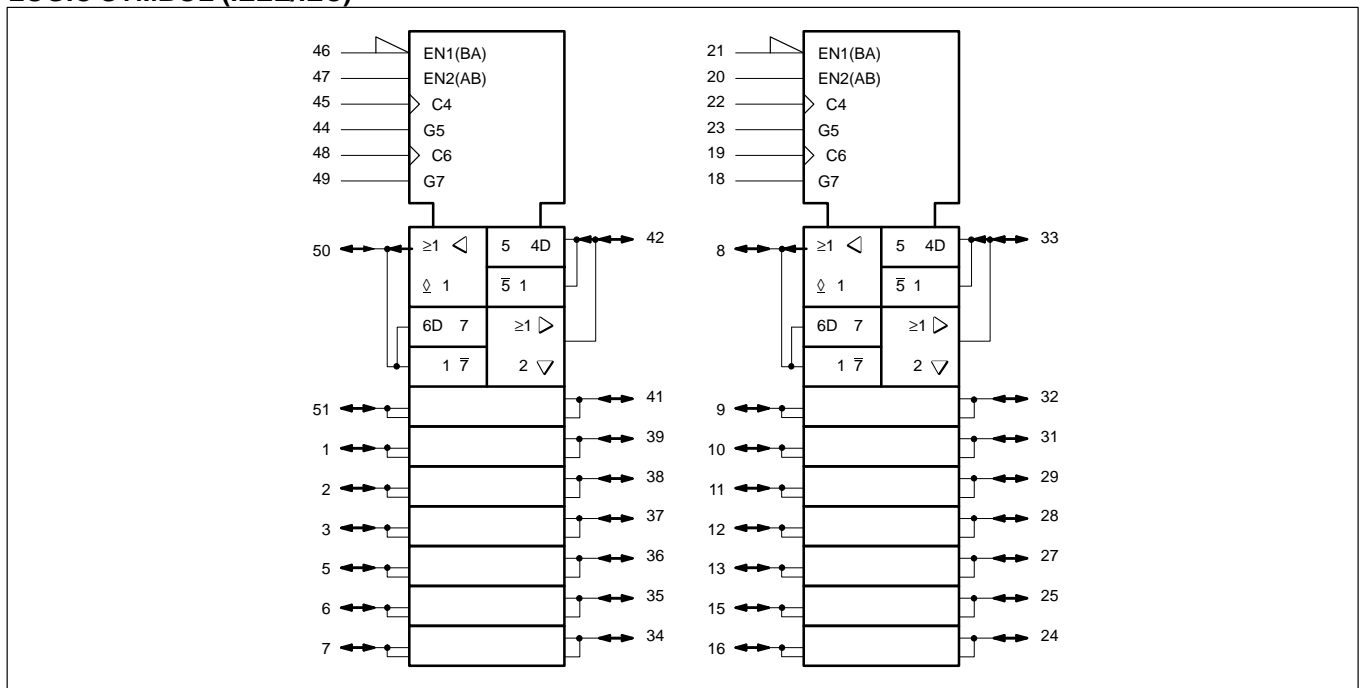

Dual octal transceiver/registers, non-inverting (3-State)

MB2652

LOGIC DIAGRAM

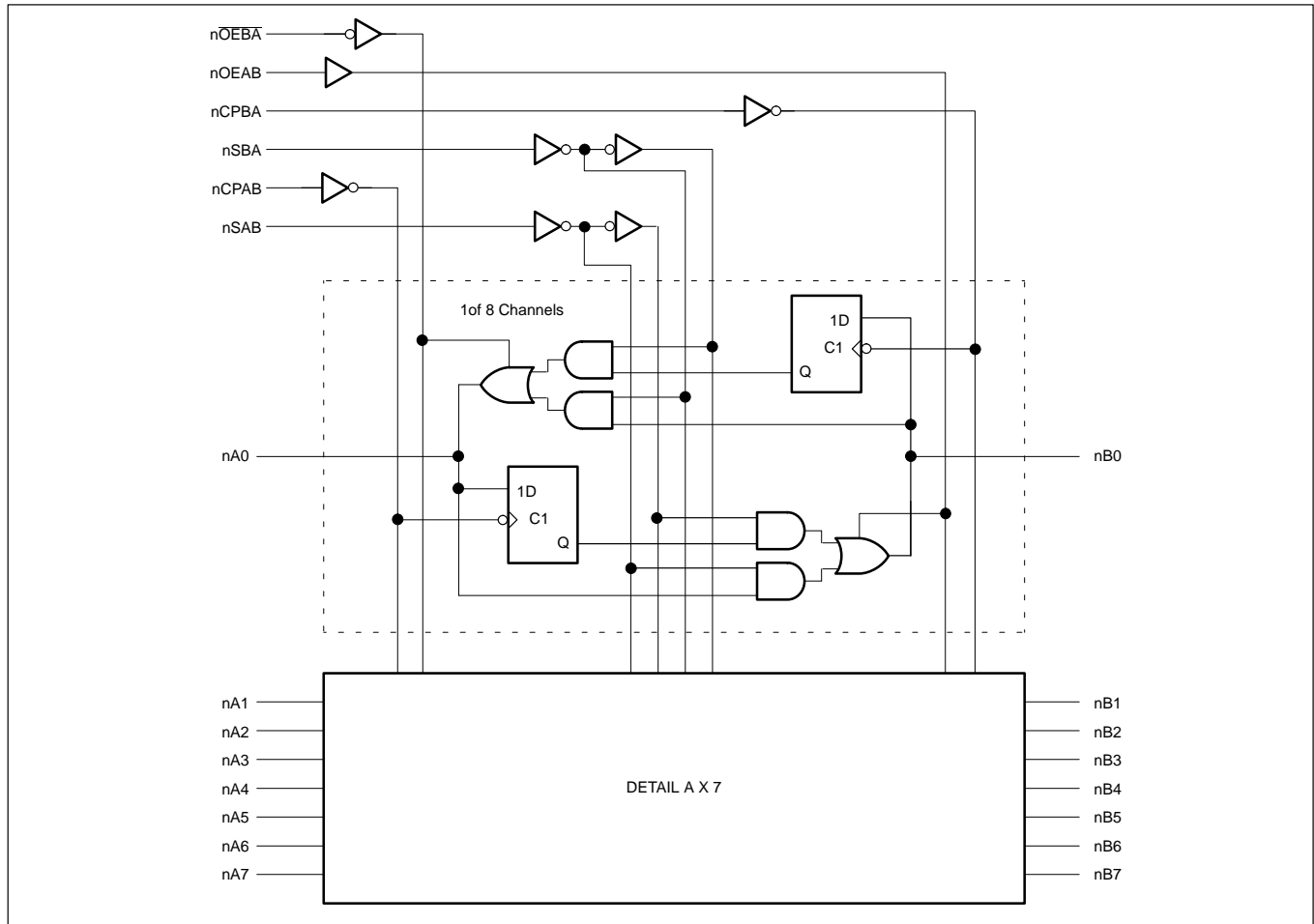

FUNCTION TABLE

INPUTS						DATA I/O		OPERATING MODE
nOEAB	nOEBA	nCPAB	nCPBA	nSAB	nSBA	nAx	nBx	
L	H	H or L	H or L	X	X	Input	Input	Isolation Store A and B data
L	H	↑	↑	X	X	Input	Input	Store A, Hold B Store A in both registers
X	H	↑	H or L	X	X	Input	Unspecified output*	Store A, Hold B Store A in both registers
H	H	↑	↑	**	X	Input	Unspecified output*	Store A, Hold B Store A in both registers
L	X	H or L	↑	X	X	Unspecified output*	Input	Hold A, Store B Store B in both registers
L	L	X	X	X	L	Output	Input	Real time B data to A bus Stored B data to A bus
L	L	X	H or L	X	H	Output	Input	Real time B data to A bus Stored B data to A bus
H	H	X	X	L	X	Input	Output	Real time A data to B bus Store A data to B bus
H	H	H or L	X	H	X	Input	Output	Real time A data to B bus Store A data to B bus
H	L	H or L	H or L	H	H	Output	Output	Stored A data to B bus Stored B data to A bus

H = High voltage level

L = Low voltage level

X = Don't care

↑ = Low-to-High clock transition

* The data output function may be enabled or disabled by various signals at the nOEBA and nOEAB inputs. Data input functions are always enabled, i.e., data at the bus pins will be stored on every Low-to-High transition of the clock.

** If both Select controls (nSAB and nSBA) are Low, then clocks can occur simultaneously. If either Select control is High, the clocks must be staggered in order to load both registers.

Dual octal transceiver/registers, non-inverting (3-State)

MB2652

The following examples demonstrate the four fundamental bus-management functions that can be performed with the MB2652. The

select pins determine whether data is stored or transferred through the device in real

time. The output enable pins determine the direction of the data flow.

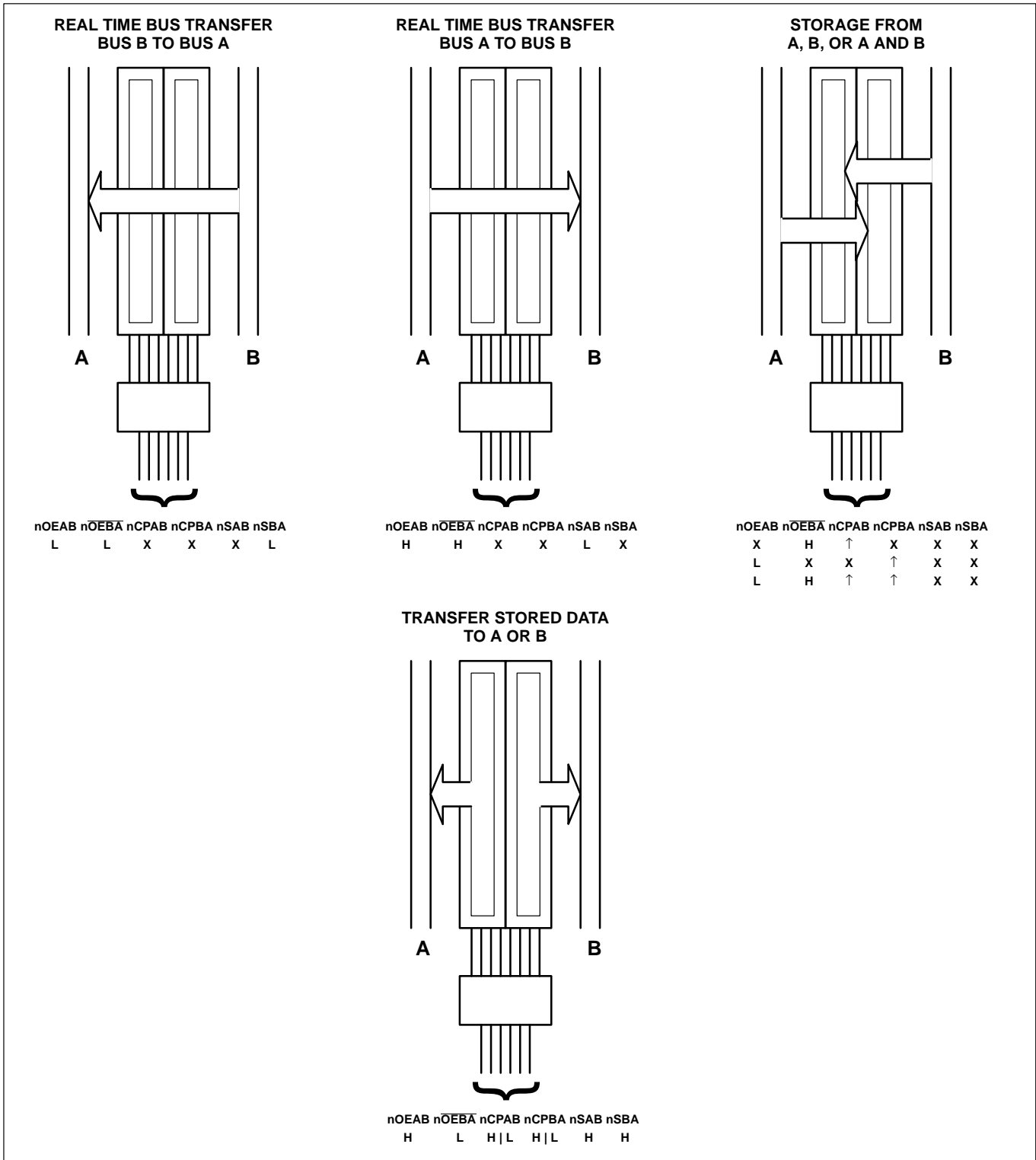

Dual octal transceiver/registers, non-inverting (3-State)

MB2652

ABSOLUTE MAXIMUM RATINGS^{1, 2}

SYMBOL	PARAMETER	CONDITIONS	RATING	UNIT
V_{CC}	DC supply voltage		-0.5 to +7.0	V
I_{IK}	DC input diode current	$V_I < 0$	-18	mA
V_I	DC input voltage ³		-1.2 to +7.0	V
I_{OK}	DC output diode current	$V_O < 0$	-50	mA
V_{OUT}	DC output voltage ³	output in Off or High state	-0.5 to +5.5	V
I_{OUT}	DC output current	output in Low state	128	mA
T_{stg}	Storage temperature range		-65 to 150	°C

NOTES:

1. Stresses beyond those listed may cause permanent damage to the device. These are stress ratings only and functional operation of the device at these or any other conditions beyond those indicated under "recommended operating conditions" is not implied. Exposure to absolute-maximum-rated conditions for extended periods may affect device reliability.
2. The performance capability of a high-performance integrated circuit in conjunction with its thermal environment can create junction temperatures which are detrimental to reliability. The maximum junction temperature of this integrated circuit should not exceed 150°C.
3. The input and output voltage ratings may be exceeded if the input and output current ratings are observed.

RECOMMENDED OPERATING CONDITIONS

SYMBOL	PARAMETER	LIMITS		UNIT
		MIN	MAX	
V_{CC}	DC supply voltage	4.5	5.5	V
V_I	Input voltage	0	V_{CC}	V
V_{IH}	High-level input voltage	2.0		V
V_{IL}	Low-level Input voltage		0.8	V
I_{OH}	High-level output current		-32	mA
I_{OL}	Low-level output current		64	mA
$\Delta t/\Delta v$	Input transition rise or fall rate	0	10	ns/V
T_{amb}	Operating free-air temperature range	-40	+85	°C

Dual octal transceiver/registers,
non-inverting (3-State)

MB2652

DC ELECTRICAL CHARACTERISTICS

SYMBOL	PARAMETER	TEST CONDITIONS	LIMITS					UNIT
			T _{amb} = +25°C			T _{amb} = -40°C to +85°C		
			MIN	TYP	MAX	MIN	MAX	
V _{IK}	Input clamp voltage	V _{CC} = 4.5V; I _{IK} = -18mA		-0.9	-1.2		-1.2	V
V _{OH}	High-level output voltage	V _{CC} = 4.5V; I _{OH} = -3mA; V _I = V _{IL} or V _{IH}	2.5	2.9		2.5		V
		V _{CC} = 5.0V; I _{OH} = -3mA; V _I = V _{IL} or V _{IH}	3.0	4.0		3.0		V
		V _{CC} = 4.5V; I _{OH} = -32mA; V _I = V _{IL} or V _{IH}	2.0	2.4		2.0		V
V _{OL}	Low-level output voltage	V _{CC} = 4.5V; I _{OL} = 64mA; V _I = V _{IL} or V _{IH}		0.42	0.55		0.55	V
V _{RST}	Power-up output low voltage ³	V _{CC} = 5.5V; I _{OL} = 1mA; V _I = GND or V _{CC}		0.13	0.55		0.55	V
I _I	Input leakage current	Control pins		±0.01	±1.0		±1.0	µA
		Data pins		±5	±100		±100	µA
I _{OFF}	Power-off leakage current	V _{CC} = 0V; V _O or V _I ≤ 4.5V		±5.0	±100		±100	µA
I _{PU/PD}	Power-up/down 3-State output current ⁴	V _{CC} = 2.0V; V _O = 0.5V; V _I = GND or V _{CC} ; V _{OE} = V _{OE} = Don't care		±5.0	±50		±50	µA
I _{IH} + I _{OZH}	3-State output High current	V _{CC} = 5.5V; V _O = 2.7V; V _I = V _{IL} or V _{IH}		5.0	50		50	µA
I _{IL} + I _{OZL}	3-State output Low current	V _{CC} = 5.5V; V _O = 0.5V; V _I = V _{IL} or V _{IH}		-5.0	-50		-50	µA
I _{CEX}	Output High leakage current	V _{CC} = 5.5V; V _O = 5.5V; V _I = GND or V _{CC}		5.0	50		50	µA
I _O	Output current ¹	V _{CC} = 5.5V; V _O = 2.5V	-50	-80	-180	-50	-180	mA
I _{CCH}	Quiescent supply current	V _{CC} = 5.5V; Outputs High, V _I = GND or V _{CC}		120	250		250	µA
I _{CCL}		V _{CC} = 5.5V; Outputs Low, V _I = GND or V _{CC}		38	60		60	mA
I _{CCZ}		V _{CC} = 5.5V; Outputs 3-State; V _I = GND or V _{CC}		120	250		250	µA
ΔI _{CC}	Additional supply current per input pin ²	V _{CC} = 5.5V; one input at 3.4V, other inputs at V _{CC} or GND		0.5	1.5		1.5	mA

NOTES:

- Not more than one output should be tested at a time, and the duration of the test should not exceed one second.
- This is the increase in supply current for each input at 3.4V.
- For valid test results, data must not be loaded into the flip-flops (or latches) after applying the power.
- This parameter is valid for any V_{CC} between 0V and 2.1V with a transition time of up to 10msec. From V_{CC} = 2.1V to V_{CC} = 5V ± 10% a transition time of up to 100µsec is permitted.

Dual octal transceiver/registers, non-inverting (3-State)

MB2652

AC CHARACTERISTICS

GND = 0V, $t_R = t_F = 2.5\text{ns}$, $C_L = 50\text{pF}$, $R_L = 500\Omega$

SYMBOL	PARAMETER	WAVEFORM	LIMITS					UNIT
			$T_{\text{amb}} = +25^\circ\text{C}$ $V_{\text{CC}} = +5.0\text{V}$			$T_{\text{amb}} = -40 \text{ to } +85^\circ\text{C}$ $V_{\text{CC}} = +5.0\text{V} \pm 0.5\text{V}$		
			MIN	TYP	MAX	MIN	MAX	
f_{MAX}	Maximum clock frequency	1	130	190		130		MHz
t_{PLH} t_{PHL}	Propagation delay nCPAB to nBx or nCPBA to nAx	1	2.1 2.7	3.9 4.4	5.3 5.7	2.1 2.7	5.8 6.3	ns
t_{PLH} t_{PHL}	Propagation delay nAx to nBx or nBx to nAx	2	1.4 1.4	3.2 3.3	4.3 4.7	1.4 1.4	4.8 5.3	ns
t_{PLH} t_{PHL}	Propagation delay nSAB to nBx or nSBA to nAx	3	1.3 2.1	3.6 3.8	5.0 5.3	1.3 2.1	5.6 5.8	ns
t_{PZH} t_{PZL}	Output enable time nOEBA to nAx	5 6	1.0 1.8	2.9 3.6	4.1 4.8	1.0 1.8	4.8 5.5	ns
t_{PHZ} t_{PLZ}	Output disable time nOEBA to nAx	5 6	1.0 1.6	3.8 3.2	5.0 4.5	1.0 1.6	5.5 5.1	ns
t_{PZH} t_{PZL}	Output enable time nOEAB to nBx	5 6	1.2 2.7	3.7 4.5	5.0 5.8	1.2 2.7	5.6 6.3	ns
t_{PHZ} t_{PLZ}	Output disable time nOEAB to nBx	5 6	1.0 1.2	3.4 3.1	4.7 4.2	1.0 1.2	5.3 4.9	ns

AC SETUP REQUIREMENTS

GND = 0V, $t_R = t_F = 2.5\text{ns}$, $C_L = 50\text{pF}$, $R_L = 500\Omega$

SYMBOL	PARAMETER	WAVEFORM	LIMITS			UNIT
			$T_{\text{amb}} = +25^\circ\text{C}$ $V_{\text{CC}} = +5.0\text{V}$		$T_{\text{amb}} = -40 \text{ to } +85^\circ\text{C}$ $V_{\text{CC}} = +5.0\text{V} \pm 0.5\text{V}$	
			MIN	TYP	MIN	
$t_s(\text{H})$ $t_s(\text{L})$	Setup time nAx to nCPBA, nBx to nCPAB	4	2.0 1.5	0.8 -0.1	2.0 1.5	ns
$t_h(\text{H})$ $t_h(\text{L})$	Hold time nAx to nCPBA, nBx to nCPAB	4	1.5 1.0	0.1 -0.7	1.5 1.0	ns
$t_w(\text{H})$ $t_w(\text{L})$	Pulse width, High or Low nCPAB or nCPBA	1	4.5 3.0	2.5 2.0	4.5 3.0	ns

Dual octal transceiver/registers, non-inverting (3-State)

MB2652

AC WAVEFORMS

$V_M = 1.5V, V_{IN} = GND \text{ to } 3.0V$

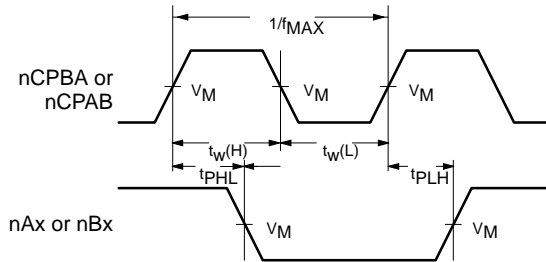

Waveform 1. Propagation Delay, Clock Input to Output, Clock Pulse Width, and Maximum Clock Frequency

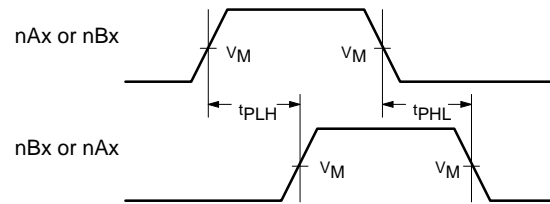

Waveform 2. Propagation Delay, nAx to nBx or nBx to nAx

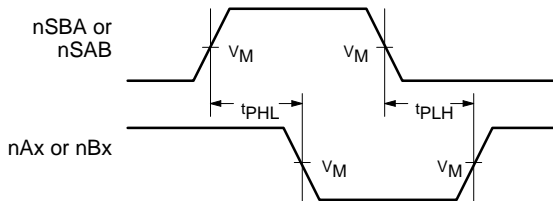

Waveform 3. Propagation Delay, SBA to nAx or SAB to nBx

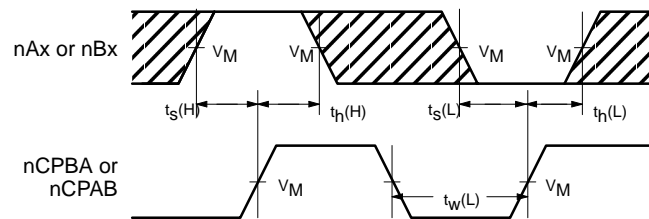

Waveform 4. Data Setup and Hold Times

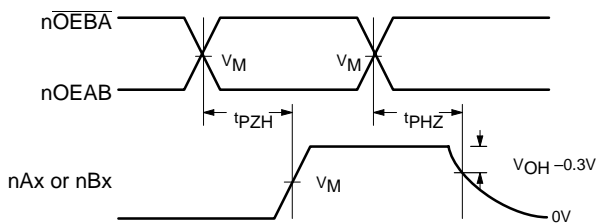

Waveform 5. 3-State Output Enable Time to High Level and Output Disable Time from High Level

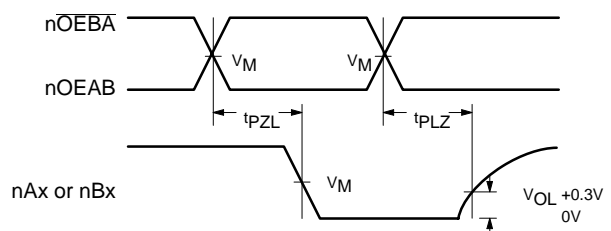

Waveform 6. 3-State Output Enable Time to Low Level and Output Disable Time from Low Level

NOTE: The shaded areas indicate when the input is permitted to change for predictable output performance.

PIN DESCRIPTION

PIN NUMBER	SYMBOL	NAME AND FUNCTION
48, 45, 19, 22	1CPAB, 1CPBA, 2CPAB, 2CPBA	Clock input A to B / Clock input B to A
49, 44, 18, 23	1SAB, 1SBA, 2SAB, 2SBA	Select input A to B / Select input B to A
50, 51, 1, 2, 3, 5, 6, 7, 8, 9, 10, 11, 12, 13, 15, 16	1A0 – 1A7, 2A0 – 2A7	Data inputs/outputs (A side)
42, 41, 39, 38, 37, 36, 35, 34, 33, 32, 31, 29, 28, 27, 25, 24	1B0 – 1B7, 2B0 – 2B7	Data inputs/outputs (B side)
47, 46, 20, 21	1OEAB, 1OEBA, 2OEAB, 2OEBA	Output enable inputs
4, 17, 30, 43	GND	Ground (0V)
14, 26, 40, 52	V _{CC}	Positive supply voltage

Dual octal transceiver/registers, non-inverting (3-State)

MB2652

TEST CIRCUIT AND WAVEFORMS

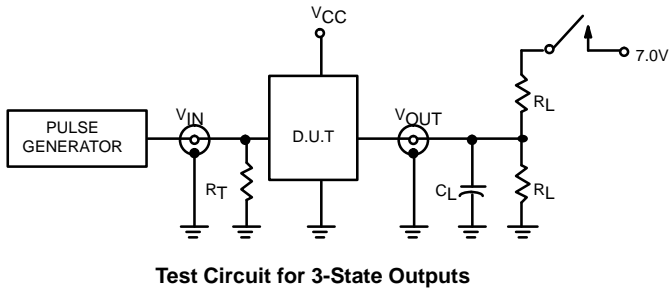

Test Circuit for 3-State Outputs

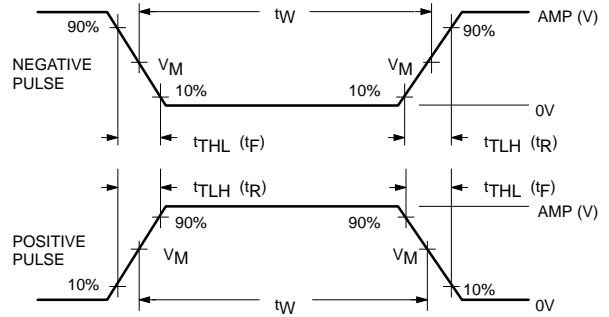

$V_M = 1.5V$
Input Pulse Definition

SWITCH POSITION

TEST	SWITCH
t_{PLZ}	closed
t_{pZL}	closed
All other	open

DEFINITIONS

- R_L = Load resistor; see AC CHARACTERISTICS for value.
- C_L = Load capacitance includes jig and probe capacitance; see AC CHARACTERISTICS for value.
- R_T = Termination resistance should be equal to Z_{OUT} of pulse generators.

FAMILY	INPUT PULSE REQUIREMENTS				
	Amplitude	Rep. Rate	t_W	t_R	t_F
MB	3.0V	1MHz	500ns	2.5ns	2.5ns

Dual octal transceiver/registers, non-inverting (3-State)

MB2652

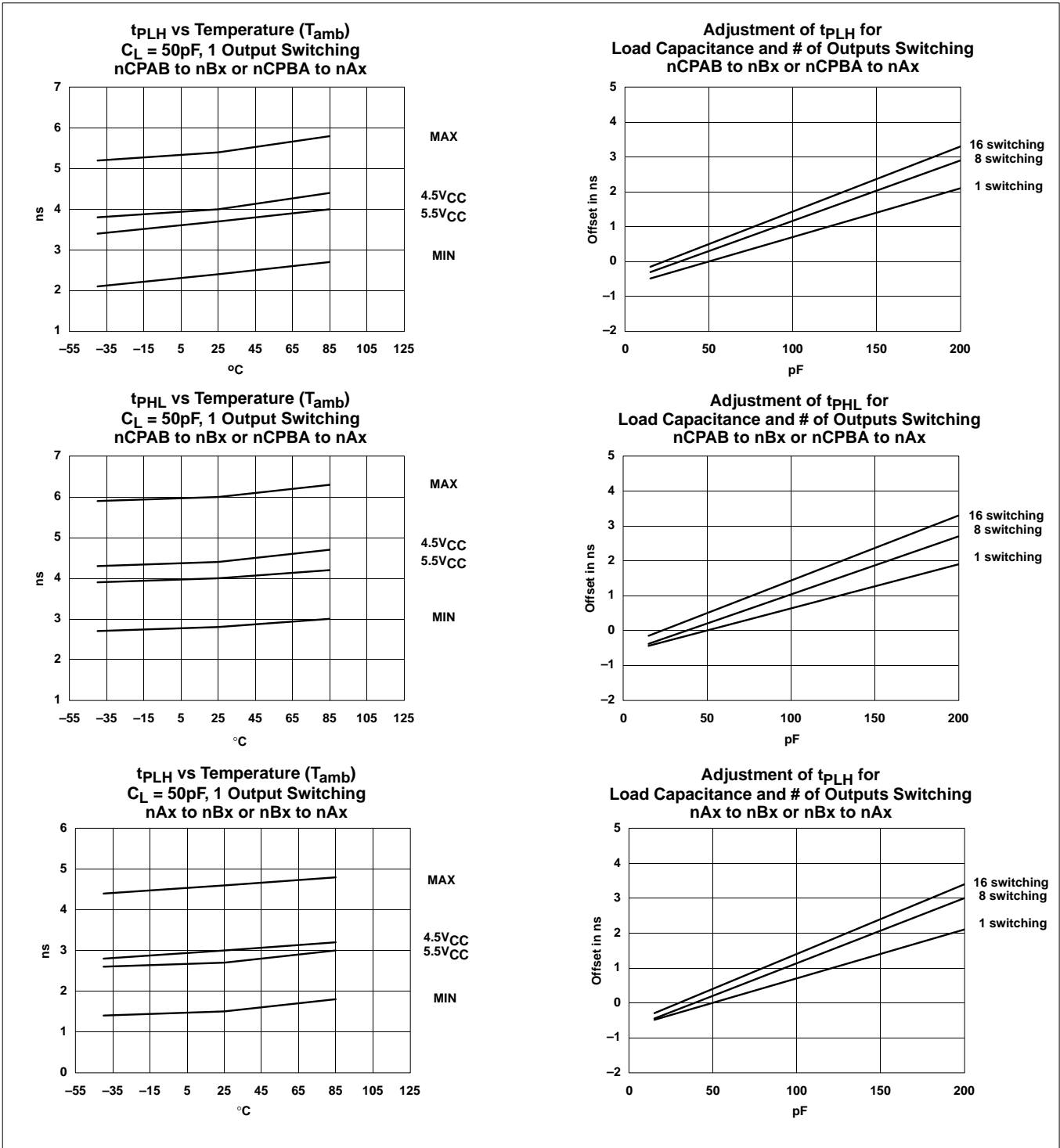

Dual octal transceiver/registers, non-inverting (3-State)

MB2652

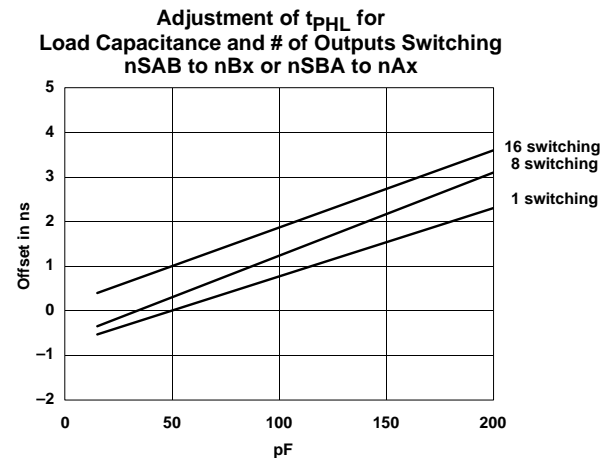
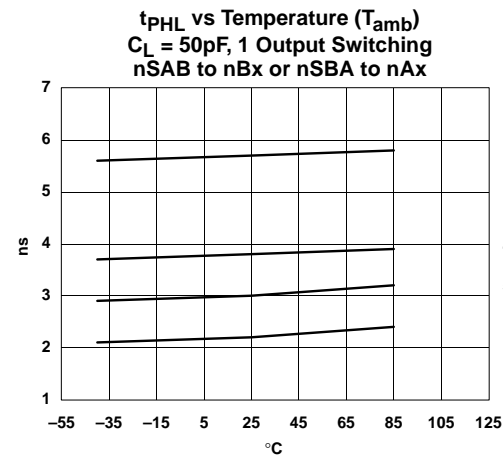
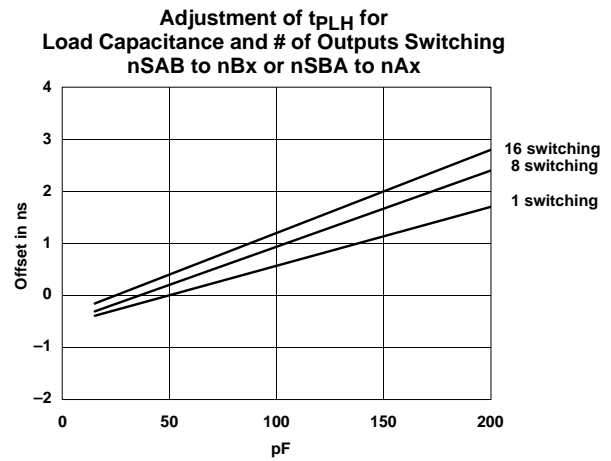
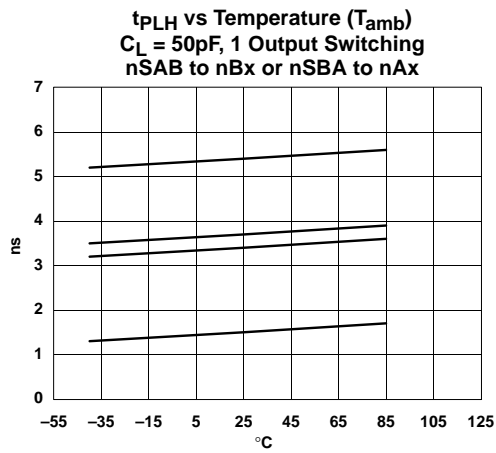
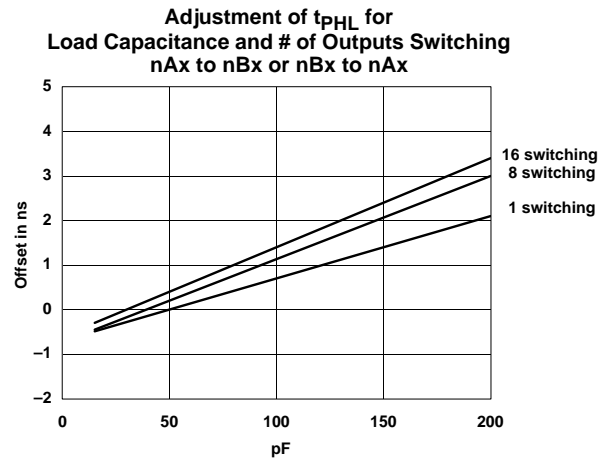
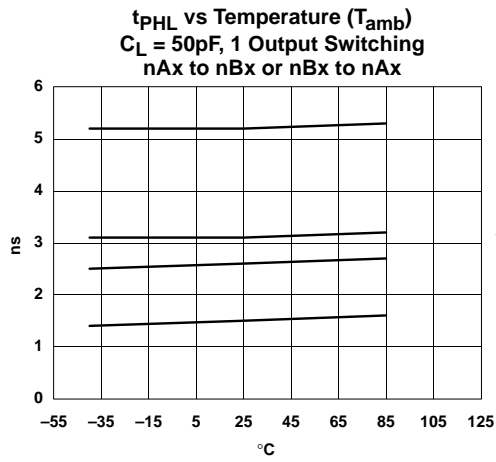

Dual octal transceiver/registers, non-inverting (3-State)

MB2652

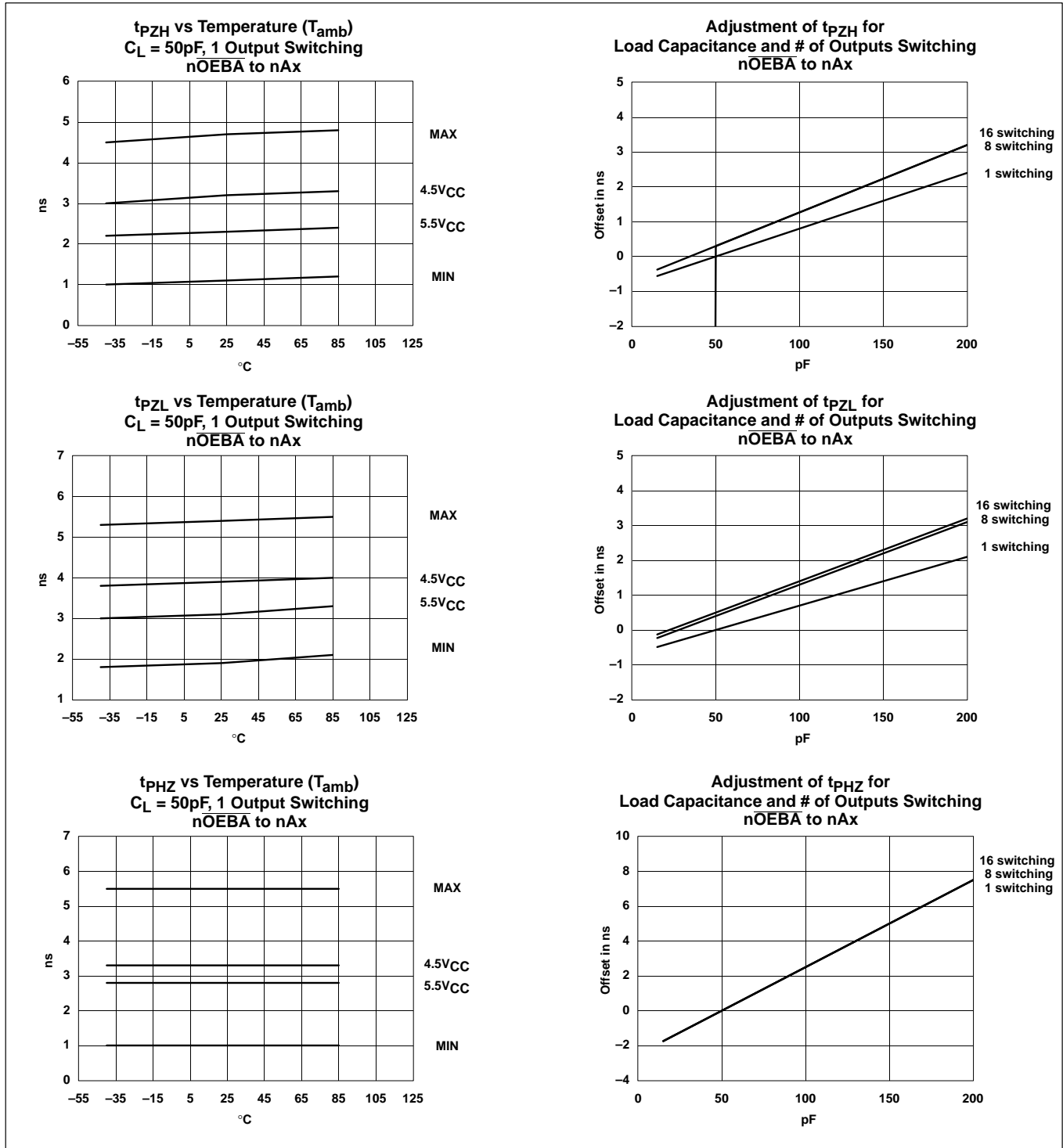

Dual octal transceiver/registers, non-inverting (3-State)

MB2652

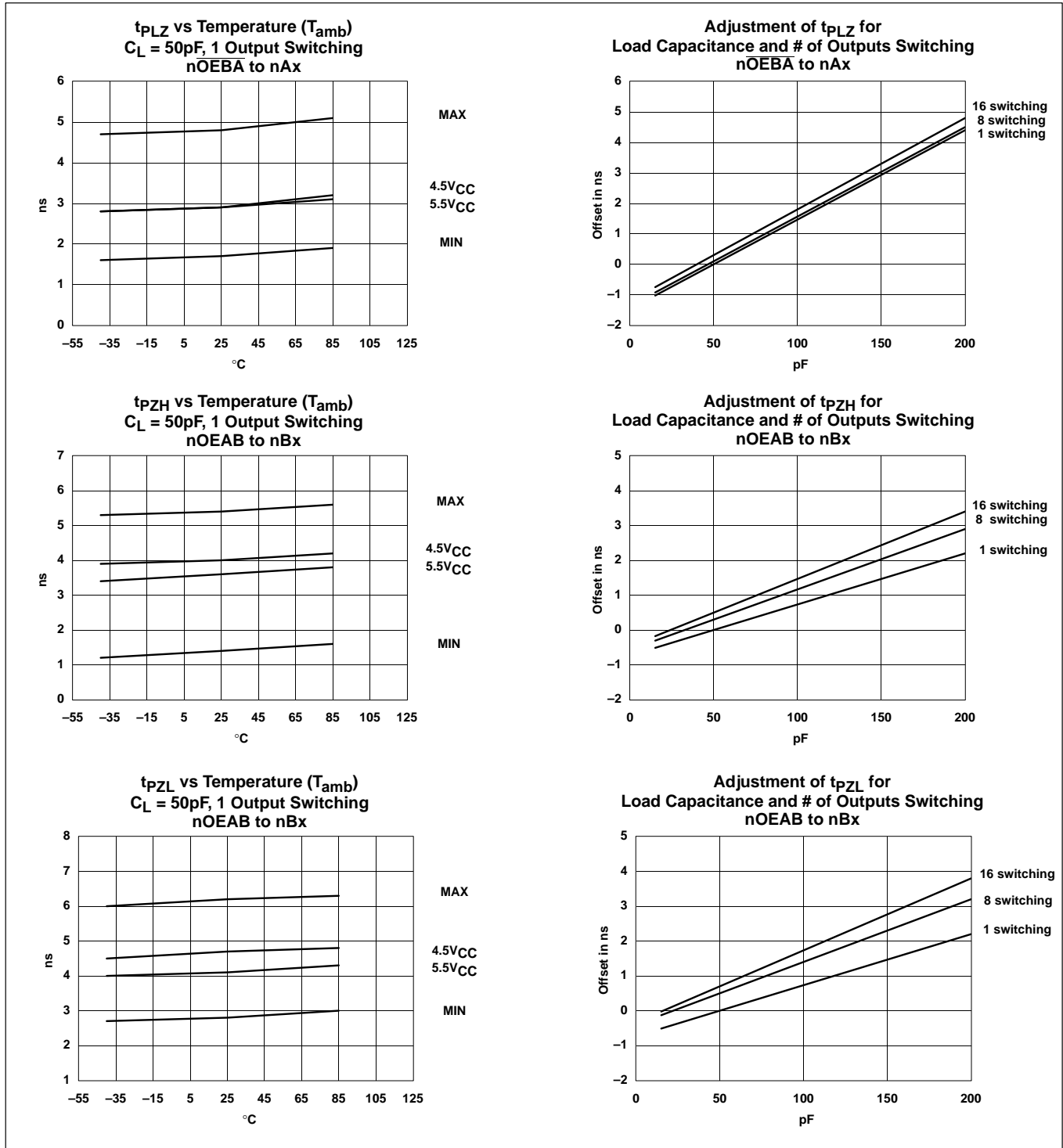

Dual octal transceiver/registers, non-inverting (3-State)

MB2652

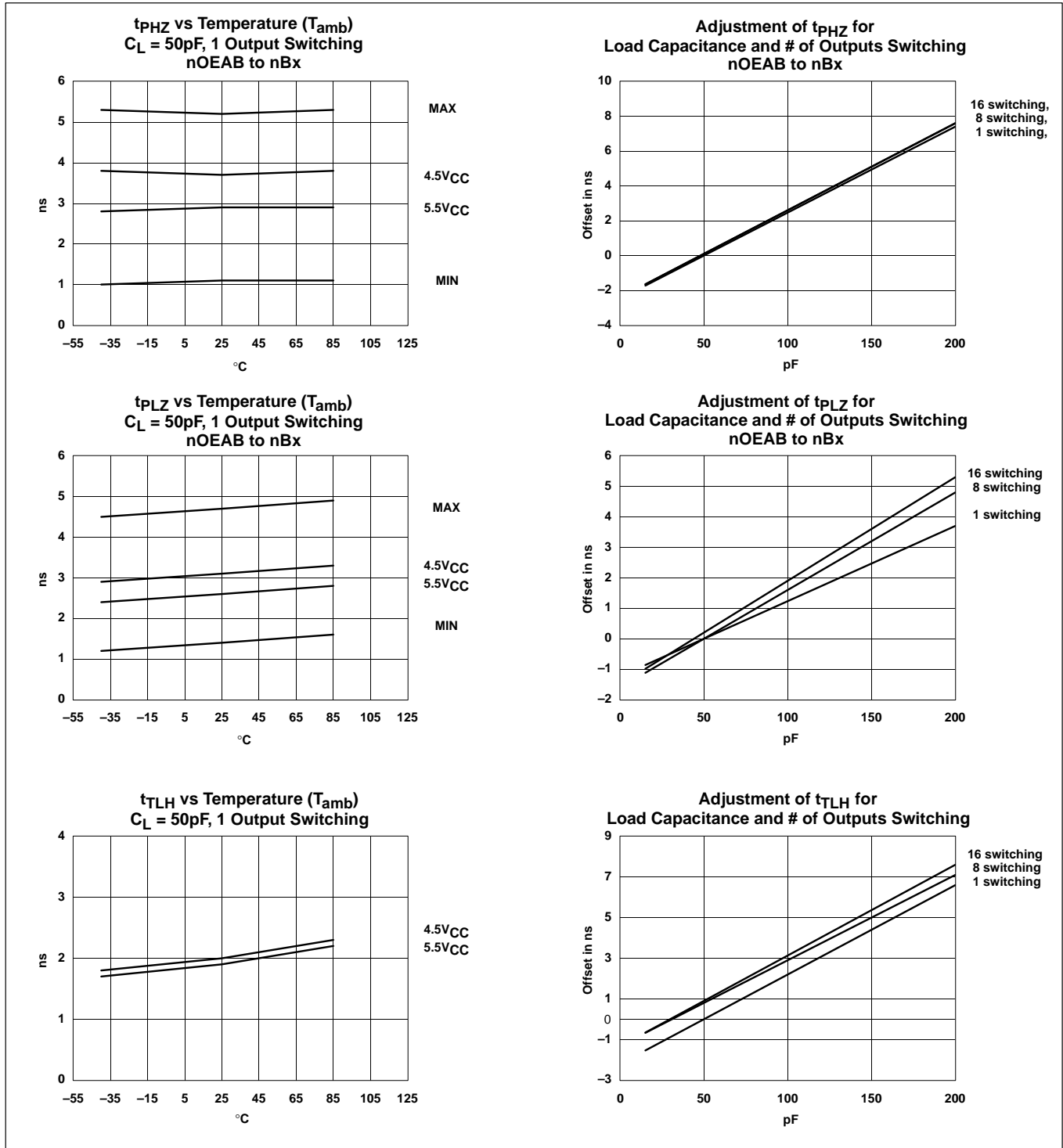

Dual octal transceiver/registers, non-inverting (3-State)

MB2652

