

# HIP3™ Variable Attenuator for AMPS and GSM Base Stations



AV131-315

## Features

- 23 dB Attenuation Range
- 1.5 dB Insertion Loss, 1.5 SWR
- 0–12 V Control Voltage
- 43 dBm IP3
- Small Footprint LGA Package
- Designed for AMPS and GSM Base Stations

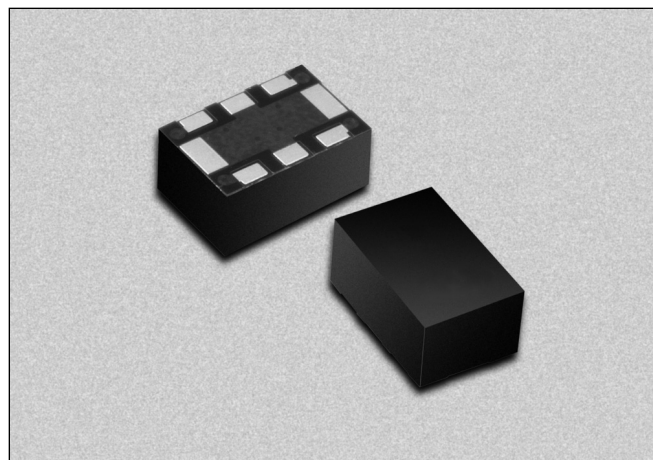

## Description

The AV131-315 is a voltage controlled variable attenuator from Skyworks' series of HIP3™ components. It is specifically designed and specified for use as a wide dynamic range low distortion attenuator for AMPS and GSM base station applications centered at 881.5 MHz and 942.5 MHz. The AV131-315 employs a monolithic quadrature hybrid and a pair of silicon PIN diodes to achieve the specified low distortion performance. It operates from 0–12 V at 1.6 mA typical control current at maximum attenuation. The AV131-315 is packaged in a small outline LGA (Land Grid Array) surface mount package with the internal elements affixed to an organic BT substrate.

## Electrical Specifications at 25°C

Parameter	Condition	Min.	Typ.	Max.	Unit
AMPS Frequency Range (BW)		869		894	MHz
GSM Frequency Range (BW)		925		960	MHz
Control Voltage ( $C_V$ ) Range		0		12	V
Insertion Loss in BW	$C_V = 0$ V			1.5	dB
Attenuation Range	At $F_O$ , $C_V = 10$ V	18		22	dB
	At $F_O$ , $C_V = 12$ V	23		–	dB
VSWR in BW				1.5	
IP3	900/905 MHz, $C_V = 0$ V	43			dBm
IM3	8 dBm			-70	dBc

**Typical Performance Data**

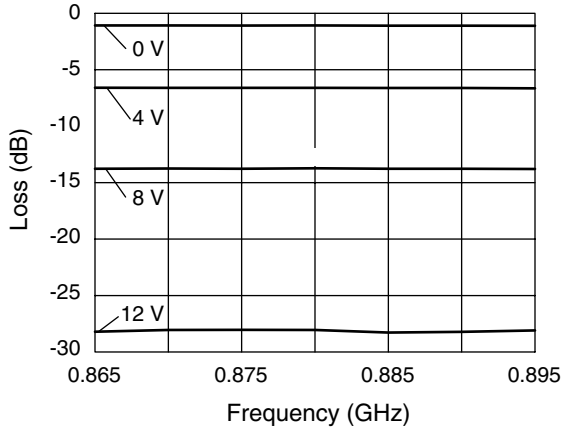

**Insertion Loss vs. Frequency and Control Voltage — AMPS Band**

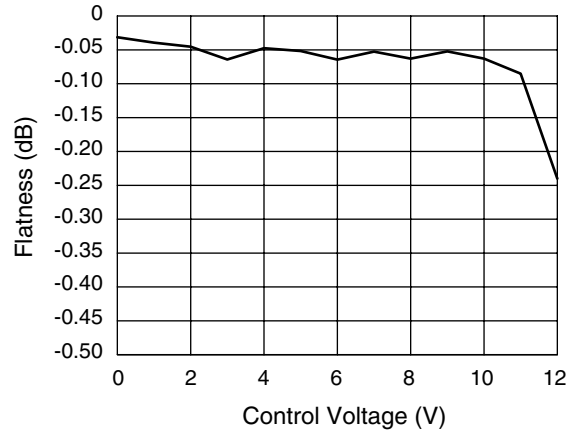

**Insertion Loss Flatness vs. Control Voltage — AMPS Band**

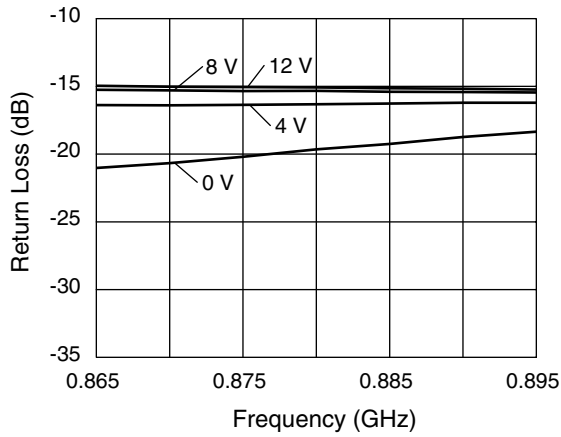

**Input/Output Return Loss vs. Frequency and Control Voltage — AMPS Band**

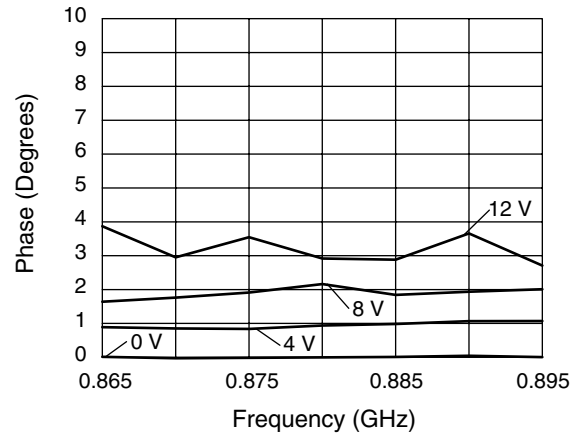

**Phase vs. Frequency and Control Voltage — AMPS Band**

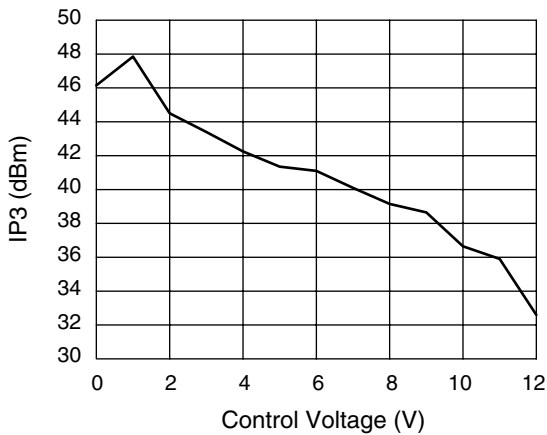

**3rd Order Intermod vs. Control Voltage**  
 RF<sub>1</sub> = 0.900 GHz, RF<sub>2</sub> = 0.905 GHz @ 8 dBm

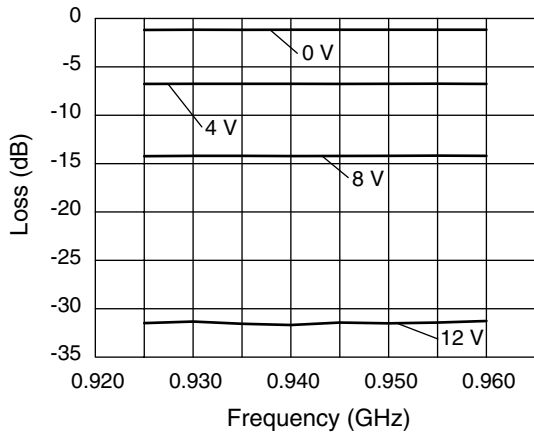

**Insertion Loss vs. Frequency and Control Voltage — GSM Band**

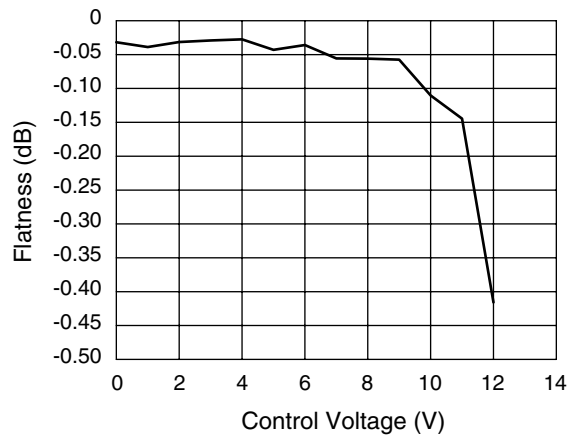

**Insertion Loss Flatness vs. Control Voltage — GSM Band**

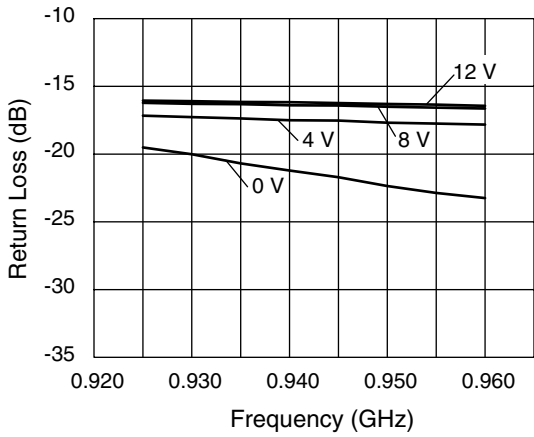

**Input/Output Return Loss vs. Frequency and Control Voltage — GSM Band**

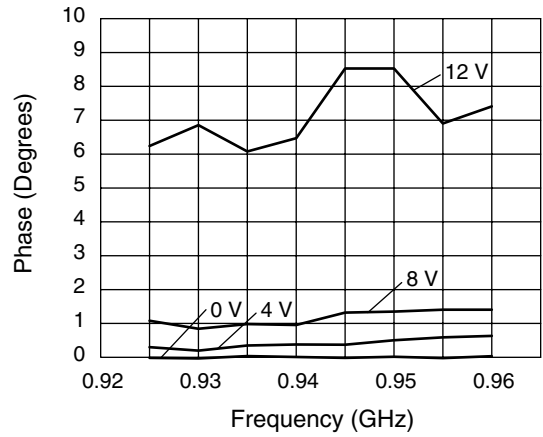

**Phase vs. Frequency and Control Voltage — GSM Band**

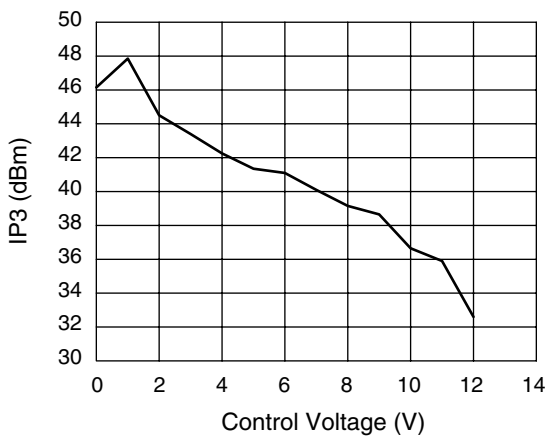

**3rd Order Intermod vs. Control Voltage  
RF<sub>1</sub> = 0.900 GHz, RF<sub>2</sub> = 0.905 GHz @ 8 dBm**

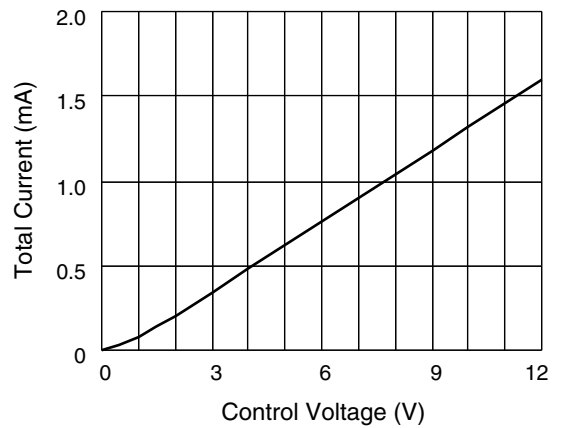

**Total Current vs. Control Voltage**

**Pin Out (Bottom View)**

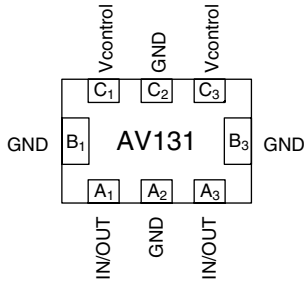

Terminal No.	Terminal Name
A <sub>1</sub> (Pin 1)	IN/OUT
A <sub>2</sub>	GND
A <sub>3</sub>	IN/OUT
B <sub>1</sub>	GND
B <sub>3</sub>	GND
C <sub>1</sub>	Vcontrol
C <sub>2</sub>	GND
C <sub>3</sub>	Vcontrol

**Absolute Maximum Ratings**

Characteristic	Value
RF Input Power	0.5 W CW, 4 W @ 12.5% Duty Cycle
Control Voltage	15 V
Control Current	50 mA Each Diode
Operating Temperature	-40 to +85°C
Storage Temperature	-40 to +85°C
Maximum Reverse Diode Voltage	-10 V
Electrostatic Discharge	+125 V

Note: Operating this device above any of these parameters may cause irreversible damage.

**Connection Diagram**

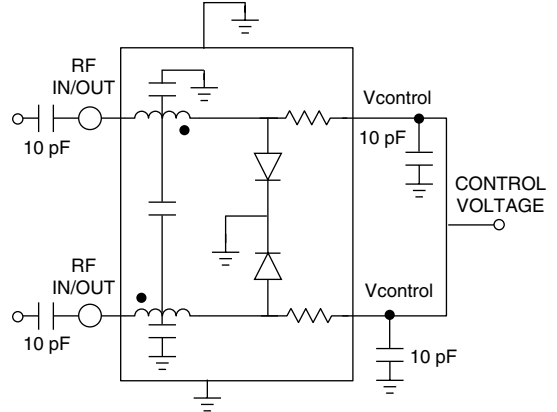

**-315**

