

Dual IGBTMOD™ U-Series Module 150 Amperes/1200 Volts

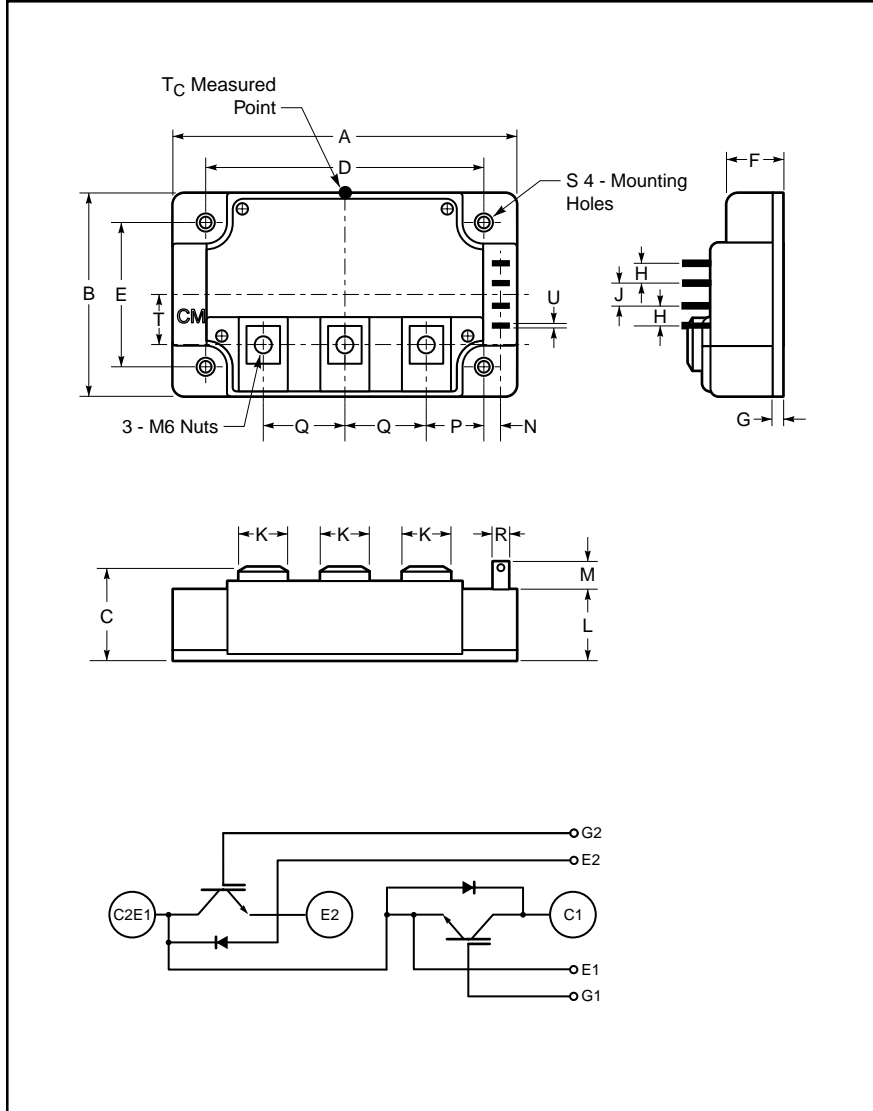

Outline Drawing and Circuit Diagram

| Dimensions | Inches | Millimeters |
|------------|------------------|--------------|
| A | 4.25 | 108.0 |
| B | 2.44 | 62.0 |
| C | 1.14 +0.04/-0.02 | 29 +1.0/-0.5 |
| D | 3.66±0.01 | 93.0±0.25 |
| E | 1.88±0.01 | 48.0±0.25 |
| F | 0.67 | 17.0 |
| G | 0.16 | 4.0 |
| H | 0.24 | 6.0 |
| J | 0.59 | 15.0 |

| Dimensions | Inches | Millimeters |
|------------|-----------|-------------|
| K | 0.55 | 14.0 |
| L | 0.87 | 22.0 |
| M | 0.33 | 8.5 |
| N | 0.10 | 2.5 |
| P | 0.85 | 21.5 |
| Q | 0.98 | 25.0 |
| R | 0.11 | 2.8 |
| S | 0.25 Dia. | 6.5 Dia. |
| T | 0.6 | 15.15 |



Description:

Powerex IGBTMOD™ Modules are designed for use in switching applications. Each module consists of two IGBT Transistors in a half-bridge configuration with each transistor having a reverse-connected super-fast recovery free-wheel diode. All components and interconnects are isolated from the heat sinking baseplate, offering simplified system assembly and thermal management.

Features:

- Low Drive Power
- Low V_{CE(sat)}
- Discrete Super-Fast Recovery Free-Wheel Diode
- Isolated Baseplate for Easy Heat Sinking

Applications:

- AC Motor Control
- Motion/Servo Control
- UPS
- Welding Power Supplies
- Laser Power Supplies

Ordering Information:

Example: Select the complete module number you desire from the table - i.e. CM150DU-24H is a 1200V (V_{CE(s)}), 150 Ampere Dual IGBTMOD™ Power Module.

| Type | Current Rating Amperes | V _{CE(s)} Volts (x 50) |
|------|------------------------|---------------------------------|
| CM | 150 | 24 |

CM150DU-24H
Dual IGBTMOD™ U-Series Module
 150 Amperes/1200 Volts

Absolute Maximum Ratings, $T_j = 25\text{ }^\circ\text{C}$ unless otherwise specified

| Ratings | Symbol | CM150DU-24H | Units |
|--|-----------|-------------|------------------|
| Junction Temperature | T_j | -40 to 150 | $^\circ\text{C}$ |
| Storage Temperature | T_{stg} | -40 to 125 | $^\circ\text{C}$ |
| Collector-Emitter Voltage (G-E SHORT) | V_{CES} | 1200 | Volts |
| Gate-Emitter Voltage (C-E SHORT) | V_{GES} | ± 20 | Volts |
| Collector Current ($T_c = 25^\circ\text{C}$) | I_C | 150 | Amperes |
| Peak Collector Current ($T_j \leq 150^\circ\text{C}$) | I_{CM} | 300* | Amperes |
| Emitter Current** ($T_c = 25^\circ\text{C}$) | I_E | 150 | Amperes |
| Peak Emitter Current** | I_{EM} | 300* | Amperes |
| Maximum Collector Dissipation ($T_c = 25^\circ\text{C}$) | P_c | 890 | Watts |
| Mounting Torque, M6 Main Terminal | – | 40 | in-lb |
| Mounting Torque, M6 Mounting | – | 40 | in-lb |
| Weight | – | 400 | Grams |
| Isolation Voltage (Main Terminal to Baseplate, AC 1 min.) | V_{iso} | 2500 | Volts |

* Pulse width and repetition rate should be such that the device junction temperature (T_j) does not exceed $T_{j(max)}$ rating.

**Represents characteristics of the anti-parallel, emitter-to-collector free-wheel diode (FWDi).

Static Electrical Characteristics, $T_j = 25\text{ }^\circ\text{C}$ unless otherwise specified

| Characteristics | Symbol | Test Conditions | Min. | Typ. | Max. | Units |
|--------------------------------------|---------------|--|------|------|------|---------------|
| Collector-Cutoff Current | I_{CES} | $V_{CE} = V_{CES}, V_{GE} = 0V$ | – | – | 1 | mA |
| Gate Leakage Voltage | I_{GES} | $V_{GE} = V_{GES}, V_{CE} = 0V$ | – | – | 0.5 | μA |
| Gate-Emitter Threshold Voltage | $V_{GE(th)}$ | $I_C = 15\text{mA}, V_{CE} = 10V$ | 4.5 | 6 | 7.5 | Volts |
| Collector-Emitter Saturation Voltage | $V_{CE(sat)}$ | $I_C = 150\text{A}, V_{GE} = 15V, T_j = 25^\circ\text{C}$ | – | 2.9 | 3.7 | Volts |
| | | $I_C = 150\text{A}, V_{GE} = 15V, T_j = 125^\circ\text{C}$ | – | 2.85 | – | Volts |
| Total Gate Charge | Q_G | $V_{CC} = 600V, I_C = 150\text{A}, V_{GE} = 15V$ | – | 560 | – | nC |
| Emitter-Collector Voltage* | V_{EC} | $I_E = 150\text{A}, V_{GE} = 0V$ | – | – | 3.2 | Volts |

* Pulse width and repetition rate should be such that the device junction temperature (T_j) does not exceed $T_{j(max)}$ rating.

Dynamic Electrical Characteristics, $T_j = 25\text{ }^\circ\text{C}$ unless otherwise specified

| Characteristics | Symbol | Test Conditions | Min. | Typ. | Max. | Units | |
|-------------------------------|---------------------|---|-------------------------------------|------|------|---------------|----|
| Input Capacitance | C_{ies} | | – | – | 22 | nf | |
| Output Capacitance | C_{oes} | $V_{CE} = 10V, V_{GE} = 0V$ | – | – | 7.4 | nf | |
| Reverse Transfer Capacitance | C_{res} | | – | – | 4.4 | nf | |
| Resistive | Turn-on Delay Time | $t_{d(on)}$ | $V_{CC} = 600V, I_C = 150\text{A},$ | – | – | 200 | ns |
| | | | | | | | |
| Switch | Turn-off Delay Time | $t_{d(off)}$ | $R_G = 2.1\Omega, \text{Resistive}$ | – | – | 300 | ns |
| | | | | | | | |
| Diode Reverse Recovery Time | t_{rr} | $I_E = 150\text{A}, di_E/dt = -300\text{A}/\mu\text{s}$ | – | – | 300 | ns | |
| Diode Reverse Recovery Charge | Q_{rr} | $I_E = 150\text{A}, di_E/dt = -300\text{A}/\mu\text{s}$ | – | 0.82 | – | μC | |

Thermal and Mechanical Characteristics, $T_j = 25\text{ }^\circ\text{C}$ unless otherwise specified

| Characteristics | Symbol | Test Conditions | Min. | Typ. | Max. | Units |
|--------------------------------------|----------------|------------------------------------|------|-------|------|---------------------------|
| Thermal Resistance, Junction to Case | $R_{th(j-c)Q}$ | Per IGBT 1/2 Module | – | – | 0.14 | $^\circ\text{C}/\text{W}$ |
| Thermal Resistance, Junction to Case | $R_{th(j-c)D}$ | Per FWDi 1/2 Module | – | – | 0.24 | $^\circ\text{C}/\text{W}$ |
| Contact Thermal Resistance | $R_{th(c-f)}$ | Per Module, Thermal Grease Applied | – | 0.020 | – | $^\circ\text{C}/\text{W}$ |

CM150DU-24H
Dual IGBTMOD™ U-Series Module
 150 Amperes/1200 Volts

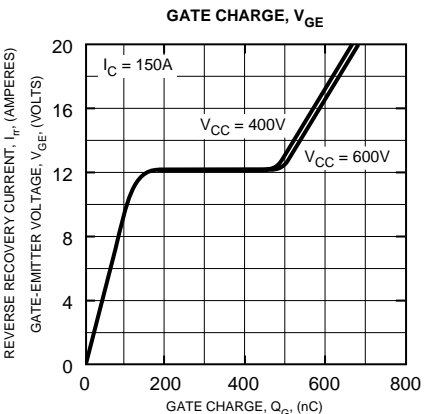
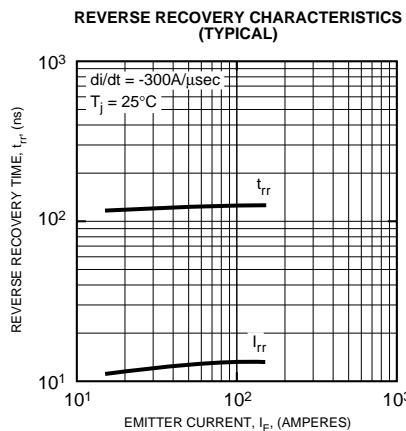
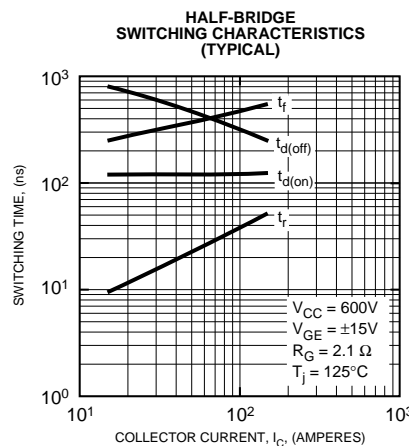
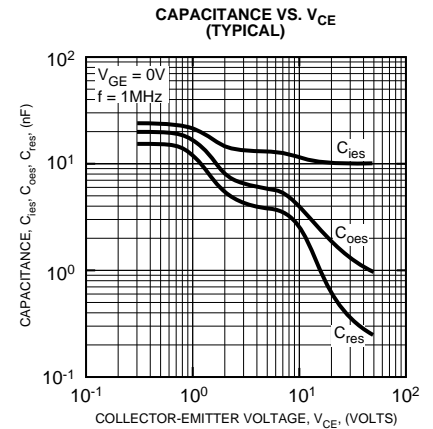
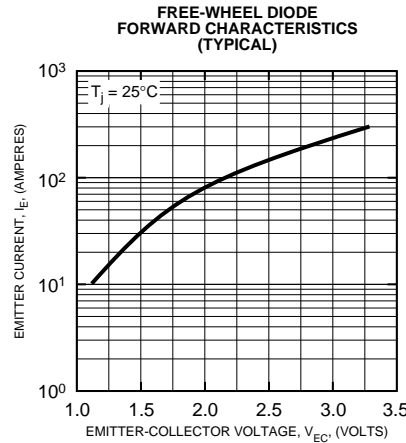
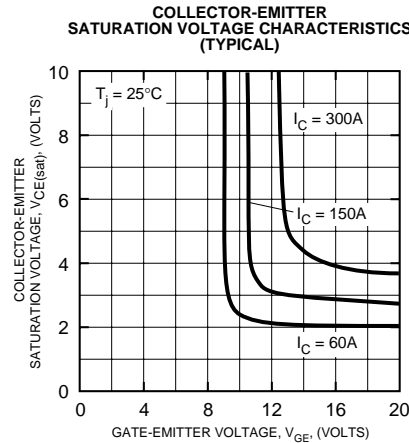
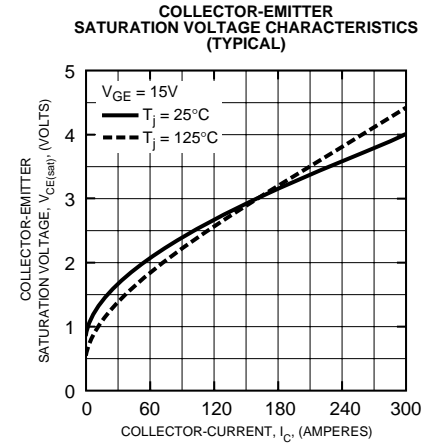
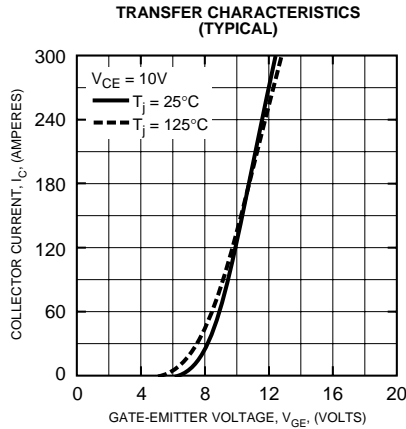
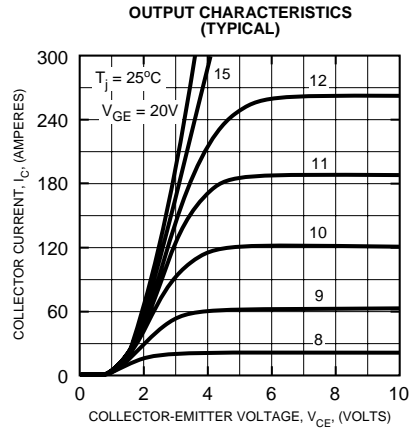

CM150DU-24H
Dual IGBTMOD™ U-Series Module
 150 Amperes/1200 Volts

