

TC4543BP/TC4543BF BCD-TO-SEVEN SEGMENT LATCH/DECODER/DRIVER (For liquid Crystals)

TC4543BP/BF is 7 segment latch/decoder/driver which can directly drive field effect type liquid crystal display element (FEM type) and equipped with BLANKING input, PHASE input and LATCH DISABLE input.

If erroneous BCD code is input, and when BI is "H", all the outputs are blanked.

When FEM type liquid crystal is driven, common pulse should be applied to the back plane of display element and the PHASE input of TC4543BP/BF.

When LED display element is to be driven, drivers should be added to the outputs.

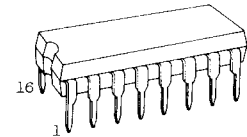

DIP16 (3D16A-P)

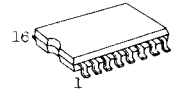

MFP16 (F16GC-P)

ABSOLUTE MAXIMUM RATINGS

CHARACTERISTIC	SYMBOL	RATING	UNIT
DC Supply Voltage	V _{DD}	V _{SS} - 0.5 ~ V _{SS} + 20	V
Input Voltage	V _{IN}	V _{SS} - 0.5 ~ V _{DD} + 0.5	V
Output Voltage	V _{OUT}	V _{SS} - 0.5 ~ V _{DD} + 0.5	V
DC Input Current	I _{IN}	±10	mA
Power Dissipation	P _D	300(DIP)/180(MFP)	mW
Operating Temperature Range	T _A	-40 ~ 85	°C
Storage Temperature Range	T _{stg}	-65 ~ 150	°C
Lead Temp./Time	T _{sol}	260°C · 10 sec	

PIN ASSIGNMENT

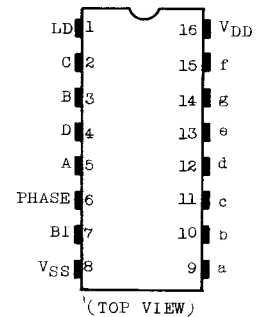

LOGIC DIAGRAM

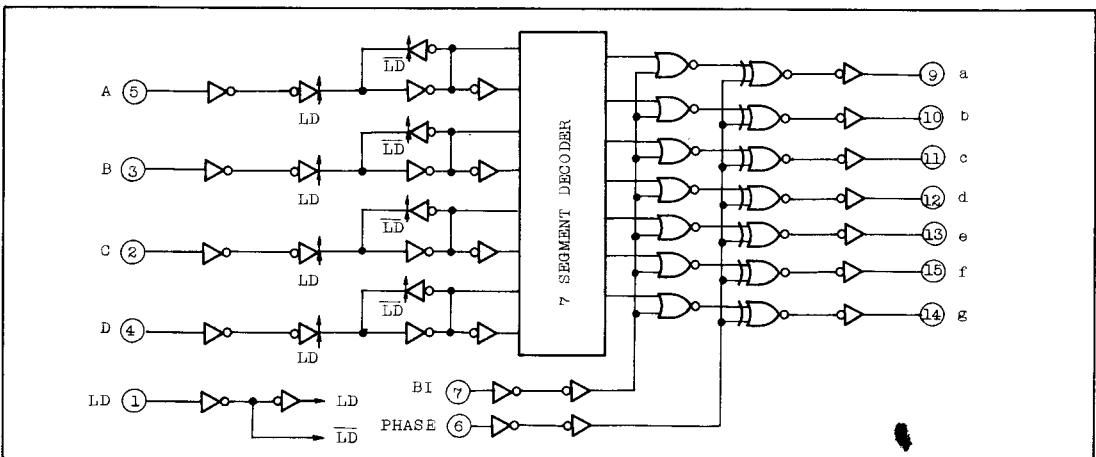

TC4543BP/BF

TRUTH TABLE

INPUTS							OUTPUTS							DISPLAY	NOTE
LD	BI	PHASE	A	B	C	D	a	b	c	d	e	f	g		
*	H	H	*	*	*	*	H	H	H	H	H	H	H	BLANK	
*	H	L	*	*	*	*	L	L	L	L	L	L	L	BLANK	
L	L	H	*	*	*	*	LATCH								
L	L	L	*	*	*	*	LATCH								
H	L	H	L	L	L	L	L	L	L	L	L	L	H	0	
H	L	H	H	L	L	L	H	L	L	H	H	H	H	1	
H	L	H	L	H	L	L	L	L	H	L	L	H	L	2	
H	L	H	H	H	L	L	L	L	L	L	H	H	L	3	
H	L	H	L	L	H	L	H	L	L	H	H	L	L	4	
H	L	H	H	L	H	L	L	H	L	L	H	L	L	5	
H	L	H	L	H	H	L	L	H	L	L	L	L	L	6	
H	L	H	H	H	H	L	L	L	L	H	H	H	H	7	
H	L	H	L	L	L	H	L	L	L	L	L	L	L	8	
H	L	H	H	L	L	H	L	L	L	L	H	L	L	9	
H	L	H	L	H	L	H	H	H	H	H	H	H	H	BLANK	
H	L	H	H	H	L	H	H	H	H	H	H	H	H	BLANK	
H	L	H	L	L	H	H	H	H	H	H	H	H	H	BLANK	
H	L	H	H	L	H	H	H	H	H	H	H	H	H	BLANK	
H	L	H	L	H	H	H	H	H	H	H	H	H	H	BLANK	
H	L	L	L	L	L	L	H	H	H	H	H	H	L	0	
H	L	L	H	L	L	L	L	H	H	L	L	L	L	1	
H	L	L	L	H	L	L	H	H	L	H	H	L	H	2	
H	L	L	H	H	L	L	H	H	H	H	L	L	H	3	
H	L	L	L	L	H	L	L	H	L	L	H	H	H	4	
H	L	L	H	L	H	L	H	L	H	H	L	H	H	5	
H	L	L	L	H	H	L	H	L	H	H	H	H	H	6	
H	L	L	H	H	H	L	H	H	H	L	L	L	L	7	
H	L	L	L	L	L	H	H	H	H	H	H	H	H	8	
H	L	L	L	L	L	H	H	H	H	L	H	H	H	9	
H	L	L	L	H	L	H	L	L	L	L	L	L	L	BLANK	
H	L	L	H	H	L	H	L	L	L	L	L	L	L	BLANK	
H	L	L	L	L	L	H	L	L	L	L	L	L	L	BLANK	
H	L	L	L	L	L	H	L	L	L	L	L	L	L	BLANK	
H	L	L	L	H	H	H	L	L	L	L	L	L	L	BLANK	
H	L	L	L	H	H	H	L	L	L	L	L	L	L	BLANK	

* : DON'T CARE

DISPLAY

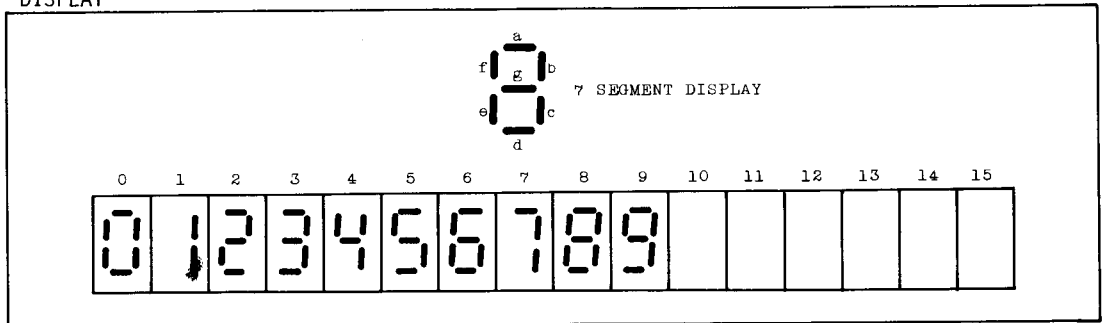

RECOMMENDED OPERATING CONDITIONS (V_{SS}=0V)

CHARACTERISTIC	SYMBOL	MIN.	TYP.	MAX.	UNITS
DC Supply Voltage	V _{DD}	3	-	18	V
Input Voltage	V _{IN}	0	-	V _{DD}	V

STATIC ELECTRICAL CHARACTERISTICS (V_{SS}=0V)

CHARACTERISTIC	SYMBOL	TEST CONDITIONS	V _{DD} (V)	-40°C		25°C			85°C		UNITS	
				MIN.	MAX.	MIN.	TYP.	MAX.	MIN.	MAX.		
High-Level Output Voltage	V _{OH}	I _{OUT} < 1μA V _{IN} =V _{SS} , V _{DD}	5	4.95	-	4.95	5.00	-	4.95	-	V	
			10	9.95	-	9.95	10.00	-	9.95	-		
			15	14.95	-	14.95	15.00	-	14.95	-		
Low-Level Output Voltage	V _{OL}	I _{OUT} < 1μA V _{IN} =V _{SS} , V _{DD}	5	-	0.05	-	0.00	0.05	-	0.05		
			10	-	0.05	-	0.00	0.05	-	0.05		
			15	-	0.05	-	0.00	0.05	-	0.05		
Output High Current	I _{OH}	V _{OH} =4.6V V _{OH} =2.5V V _{OH} =9.5V V _{OH} =13.5V V _{IN} =V _{SS} , V _{DD}	5	-0.61	-	-0.51	-1.0	-	-0.42	-	mA	
			5	-2.5	-	-2.1	-4.0	-	-1.7	-		
			10	-1.5	-	-1.3	-2.2	-	-1.1	-		
			15	-4.0	-	-3.4	-9.0	-	-2.8	-		
			15	-4.0	-	-3.4	-9.0	-	-2.8	-		
Output Low Current	I _{OL}	V _{OL} =0.4V V _{OL} =0.5V V _{OL} =1.5V V _{IN} =V _{SS} , V _{DD}	5	0.61	-	0.51	1.2	-	0.42	-		
			10	1.5	-	1.3	3.2	-	1.1	-		
			15	4.0	-	3.4	12.0	-	2.8	-		
			15	4.0	-	3.4	12.0	-	2.8	-		
Input High Voltage	V _{IH}	V _{OUT} =0.5V, 4.5V V _{OUT} =1.0V, 9.0V V _{OUT} =1.5V, 13.5V I _{OUT} < 1μA	5	3.5	-	3.5	2.75	-	3.5	-	V	
			10	7.0	-	7.0	5.5	-	7.0	-		
			15	11.0	-	11.0	8.25	-	11.0	-		
			15	11.0	-	11.0	8.25	-	11.0	-		
Input Low Voltage	V _{IL}	V _{OUT} =0.5V, 4.5V V _{OUT} =1.0V, 9.0V V _{OUT} =1.5V, 13.5V I _{OUT} < 1μA	5	-	1.5	-	2.25	1.5	-	1.5		
			10	-	3.0	-	4.5	3.0	-	3.0		
			15	-	4.0	-	6.75	4.0	-	4.0		
			15	-	4.0	-	6.75	4.0	-	4.0		
Input Current	"H" Level	I _{IH}	V _{IH} =18V	18	-	0.1	-	10 ⁻⁵	0.1	-	1.0	μA
	"H" Level	I _{IL}	V _{IL} =0V	18	-	-0.1	-	-10 ⁻⁵	-0.1	-	-1.0	
Quiescent Device Current	I _{DD}	V _{IN} =V _{SS} , V _{DD} *	5	-	5	-	0.005	5	-	150	μA	
			10	-	10	-	0.010	10	-	300		
			15	-	20	-	0.015	20	-	600		

* All valid input combinations.

TC4543BP/BF

DYNAMIC ELECTRICAL CHARACTERISTICS (Ta=25°C, VSS=0V, CL=50pF)

CHARACTERISTICS	SYMBOL	TEST CONDITION	VDD (V)	MIN.	TYP.	MAX.	UNITS
Output Transition Time (Low to High)	t _{TLH}		5	-	70	200	ns
			10	-	35	100	
			15	-	30	80	
Output Transition Time (High to Low)	t _{THL}		5	-	70	200	
			10	-	35	100	
			15	-	30	80	
Propagation Delay Time (A ~ D - OUT)	t _{pLH} t _{pHL}		5	-	280	1000	
			10	-	140	400	
			15	-	100	300	
Propagation Delay Time (BI - OUT)	t _{pLH} t _{pHL}		5	-	140	500	
			10	-	70	200	
			15	-	55	150	
Propagation Delay Time (LD - OUT)	t _{pLH} t _{pHL}		5	-	300	1000	
			10	-	140	400	
			15	-	100	300	
Propagation Delay Time (PHASE - OUT)	t _{pLH} t _{pHL}		5	-	170	550	
			10	-	85	220	
			15	-	65	180	
Min. Pulse Width (LD)	t _{WH}		5	-	30	250	
			10	-	25	100	
			15	-	20	80	
Min. Set-up Time (LD - A ~ D)	t _{SU}		5	-	20	60	
			10	-	10	20	
			15	-	5	10	
Min. Hold Time (LD - A ~ D)	t _H		5	-	0	25	
			10	-	0	20	
			15	-	0	20	
Input Capacitance	C _{IN}			-	5	7.5	pF

WAVEFORM FOR MEASUREMENT OF DYNAMIC CHARACTERISTICS

WAVEFORM 1

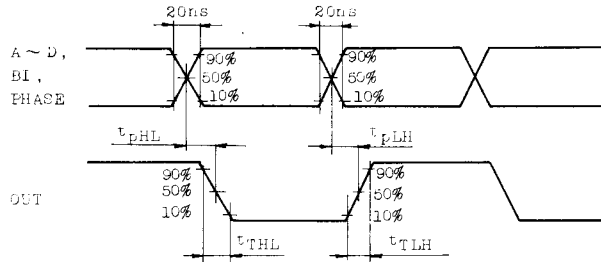

WAVEFORM 2

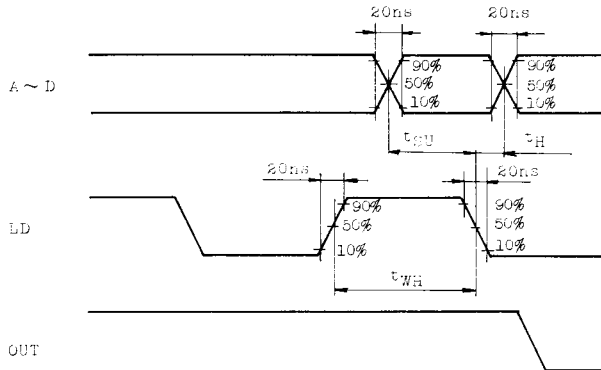

WAVEFORM 3

