

The RF MOSFET Line  
**RF Power**  
**Field Effect Transistors**  
N-Channel Enhancement-Mode Lateral  
MOSFETs

Designed for broadband commercial and industrial applications at frequencies to 1.0 GHz. The high gain and broadband performance of these devices makes them ideal for large-signal, common source amplifier applications in 28 volt base station equipment.

- Guaranteed Performance at 945 MHz, 28 Volts  
Output Power – 45 Watts PEP  
Power Gain – 11.5 dB  
Efficiency – 33%  
IMD – 28 dBc
- Characterized with Series Equivalent Large-Signal Impedance Parameters
- S-Parameter Characterization at High Bias Levels
- Excellent Thermal Stability
- 100% Tested for Load Mismatch Stress at all Phase Angles with 5:1 VSWR @ 28 Vdc, 945 MHz, 45 Watts CW

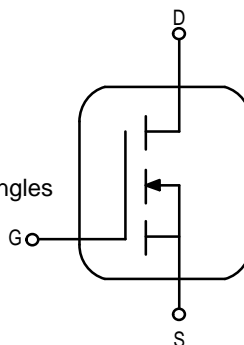

**MRF183**  
**MRF183S**

**45 W, 1.0 GHz**  
**LATERAL N-CHANNEL**  
**BROADBAND**  
**RF POWER MOSFETs**

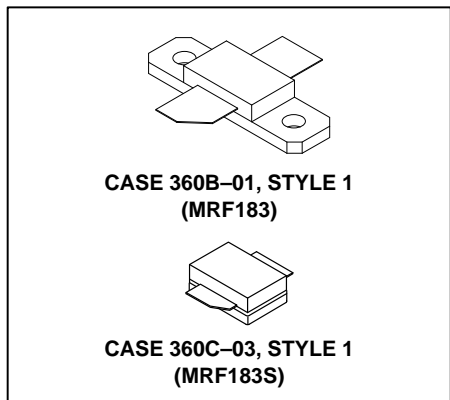

**MAXIMUM RATINGS**

Rating	Symbol	Value	Unit
Drain-Source Voltage	V <sub>DSS</sub>	65	Vdc
Drain-Gate Voltage (RGS = 1 Meg Ohm)	V <sub>DGR</sub>	65	Vdc
Gate-Source Voltage	V <sub>GS</sub>	±20	Vdc
Drain Current – Continuous	I <sub>D</sub>	5	Adc
Total Device Dissipation @ T <sub>C</sub> = 70°C Derate above 70°C	P <sub>D</sub>	86 0.67	W W/°C
Storage Temperature Range	T <sub>stg</sub>	- 65 to +200	°C
Operating Junction Temperature	T <sub>J</sub>	200	°C

**THERMAL CHARACTERISTICS**

Characteristic	Symbol	Max	Unit
Thermal Resistance, Junction to Case	R <sub>θJC</sub>	1.5	°C/W

**NOTE – CAUTION** – MOS devices are susceptible to damage from electrostatic charge. Reasonable precautions in handling and packaging MOS devices should be observed.

**ELECTRICAL CHARACTERISTICS** ( $T_C = 25^\circ\text{C}$  unless otherwise noted)

Characteristic	Symbol	Min	Typ	Max	Unit
----------------	--------	-----	-----	-----	------

**OFF CHARACTERISTICS**

Drain–Source Breakdown Voltage ( $V_{GS} = 0$ , $I_D = 50 \mu\text{A}$ )	$BV_{DSS}$	65	–	–	Vdc
Zero Gate Voltage Drain Current ( $V_{DS} = 28 \text{ V}$ , $V_{GS} = 0$ )	$I_{DSS}$	–	–	1	$\mu\text{A}$
Gate–Source Leakage Current ( $V_{GS} = 20 \text{ V}$ , $V_{DS} = 0$ )	$I_{GSS}$	–	–	1	$\mu\text{A}$

**ON CHARACTERISTICS**

Gate Quiescent Voltage ( $V_{DS} = 28 \text{ Vdc}$ , $I_D = 250 \text{ mA}$ )	$V_{GS(Q)}$	3	–	5	Vdc
Drain–Source On–Voltage ( $V_{GS} = 10 \text{ V}$ , $I_D = 3 \text{ A}$ )	$V_{DS(on)}$	–	0.7	–	Vdc
Forward Transconductance ( $V_{DS} = 10 \text{ Vdc}$ , $I_D = 5 \text{ A}$ )	$g_{fs}$	–	2	–	S

**DYNAMIC CHARACTERISTICS**

Input Capacitance ( $V_{DS} = 28 \text{ V}$ , $V_{GS} = 0$ , $f = 1 \text{ MHz}$ )	$C_{iss}$	–	82	–	pF
Output Capacitance ( $V_{DS} = 28 \text{ V}$ , $V_{GS} = 0$ , $f = 1 \text{ MHz}$ )	$C_{oss}$	–	38	–	pF
Reverse Transfer Capacitance ( $V_{DS} = 28 \text{ V}$ , $V_{GS} = 0$ , $f = 1 \text{ MHz}$ )	$C_{rss}$	–	4.5	–	pF

**FUNCTIONAL TESTS** (In Motorola Test Fixture)

( $V_{DD} = 28 \text{ Vdc}$ ,  $P_{out} = 45 \text{ Watts PEP}$ ,  $f_1 = 945.0$ ,  $f_2 = 945.1 \text{ MHz}$ ,  $I_{DQ} = 250 \text{ mA}$ )

Two–Tone Common Source Amplifier Power Gain	$G_{ps}$	11.5	13	–	dB
Two–Tone Drain Efficiency	$\eta$	33	36	–	%
3rd Order Intermodulation Distortion	IMD	–	–32	–28	dBc
Input Return Loss	IRL	9	14	–	dB

( $V_{DD} = 28 \text{ Vdc}$ ,  $P_{out} = 45 \text{ Watts PEP}$ ,  $f_1 = 930.0$ ,  $f_2 = 930.1 \text{ MHz}$ , and  $f_1 = 960.0$ ,  $f_2 = 960.1 \text{ MHz}$ ,  $I_{DQ} = 250 \text{ mA}$ )

Two–Tone Common Source Amplifier Power Gain	$G_{ps}$	–	13	–	dB
Two–Tone Drain Efficiency	$\eta$	–	35	–	%
3rd Order Intermodulation Distortion	IMD	–	–32	–	dBc
Input Return Loss	IRL	–	12	–	dB
Output Mismatch Stress ( $V_{DD} = 28 \text{ Vdc}$ , $P_{out} = 45 \text{ Watts CW}$ , $I_{DQ} = 250 \text{ mA}$ , $f = 945 \text{ MHz}$ , VSWR 5:1 at All Phase Angles)	$\Psi$	No Degradation in Output Power Before and After Test			

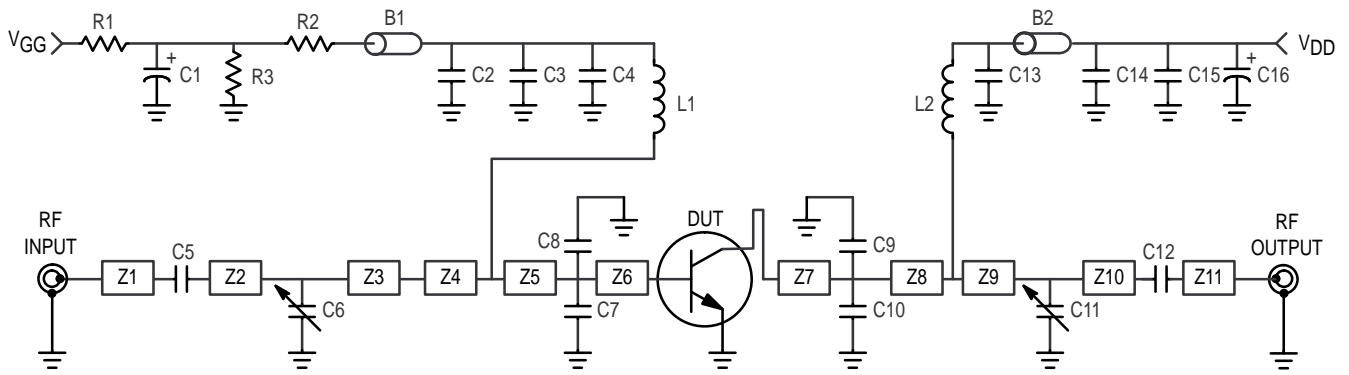

B1	Short Ferrite Bead	R3	4.7 M $\Omega$ , 1/4 W Carbon
B2	Long Ferrite Bead	Z1	T-Line, 0.200" x 0.080"
C1	10 $\mu$ F, 50 V Electrolytic Capacitor	Z2	T-Line, 0.570" x 0.120"
C2, C14	0.1 $\mu$ F Chip Capacitor	Z3	T-Line, 0.610" x 0.320"
C3	1000 pF Chip Capacitor	Z4	T-Line, 0.160" x 0.320" x 0.620"
C4, C13	47 pF Chip Capacitor	Z5	Tapered Line
C5, C12	47 pF Chip Capacitor	Z6	T-Line, 0.650" x 0.620"
C6, C11	0.8–8.0 pF Trim Capacitor	Z7	T-Line, 0.020" x 0.620"
C7, C8	10 pF Chip Capacitor	Z8	T-Line, 0.270" x 0.320"
C9, C10	10 pF Chip Capacitor	Z9	T-Line, 0.130" x 0.320"
C15	100 pF Chip Capacitor	Z10	T-Line, 0.370" x 0.080"
C16	250 $\mu$ F, 50 V Electrolytic Capacitor	Z11	T-Line, 1.050" x 0.080"
L1, L2	5 Turns, 24 AWG, ID 0.059"	Z11	T-Line, 0.290" x 0.080"
R1	120 $\Omega$ , 1/4 W Carbon	Board	0.030" Glass Teflon, $\epsilon_r = 2.55$
R2	18 k $\Omega$ , 1/4 W Carbon		ARLON-GX-0300-55-22

**Figure 1. MRF183S Two Tone Test Circuit Schematic**

## TYPICAL CHARACTERISTICS

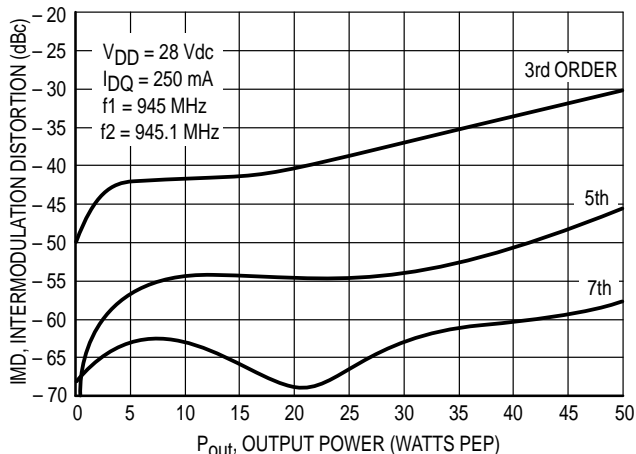

**Figure 2. Intermodulation Distortion versus Output Power**

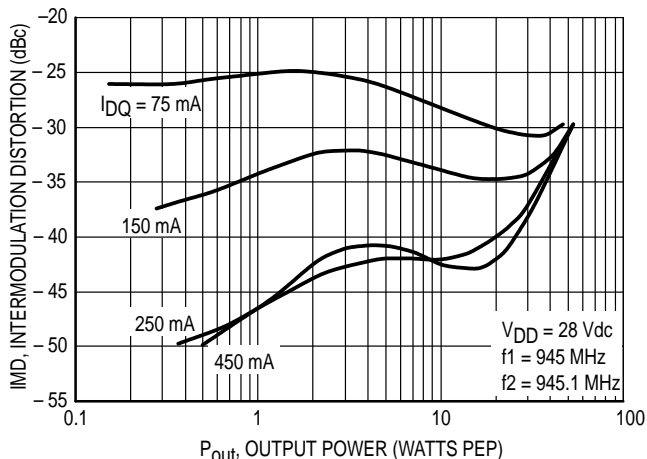

**Figure 3. Intermodulation Distortion versus Output Power**

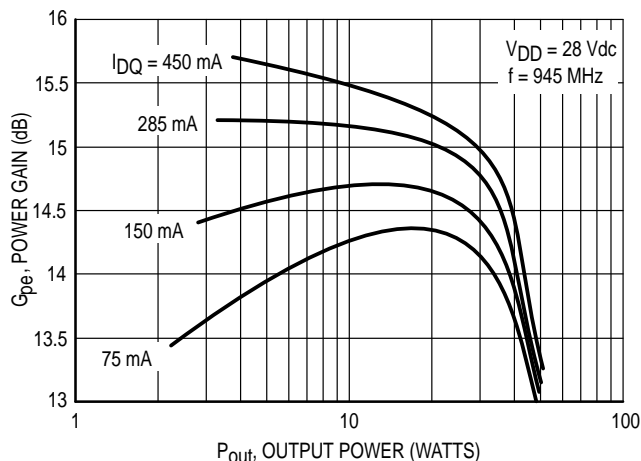

**Figure 4. Power Gain versus Output Power**

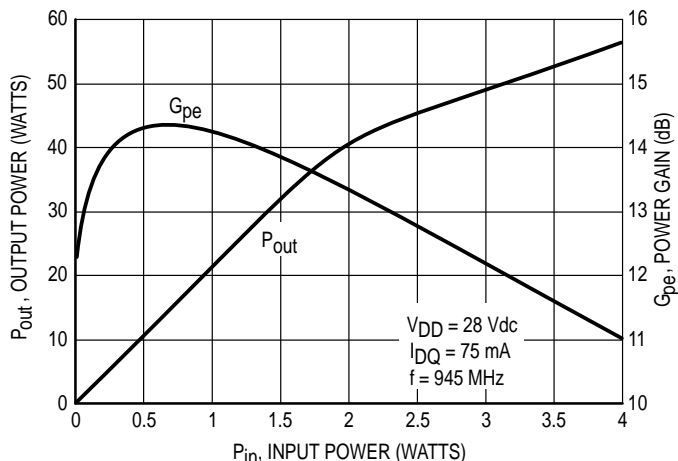

**Figure 5. Output Power versus Input Power**

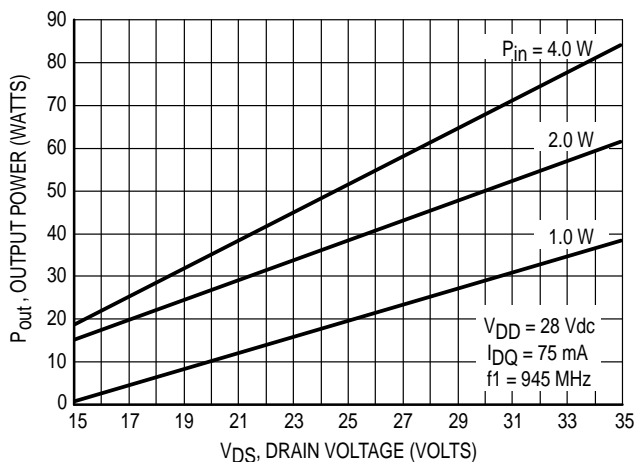

**Figure 6. Output Power versus Drain Bias Supply Voltage**

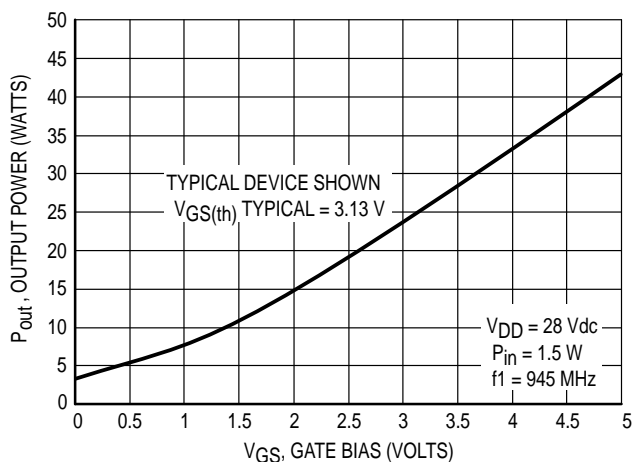

**Figure 7. Output Power versus Gate Bias Supply Voltage**

## TYPICAL CHARACTERISTICS

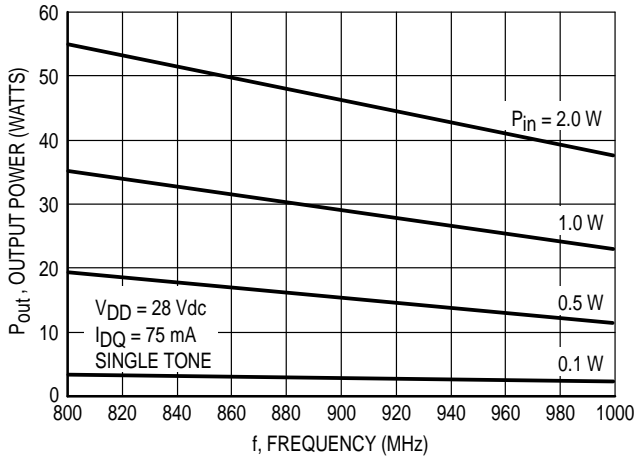

Figure 8. Output Power versus Frequency

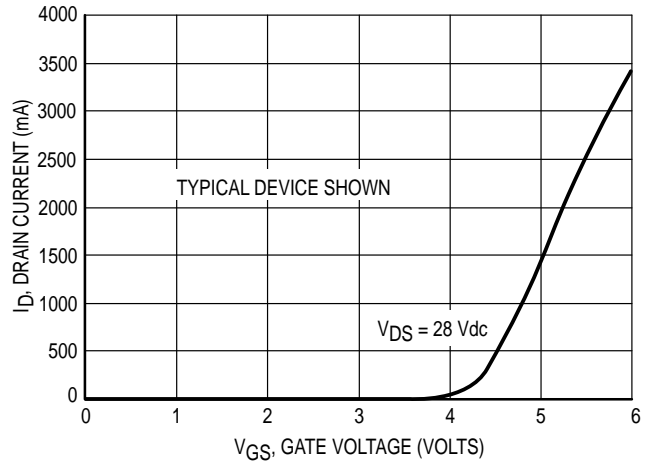

Figure 9. Drain Current versus Gate Voltage

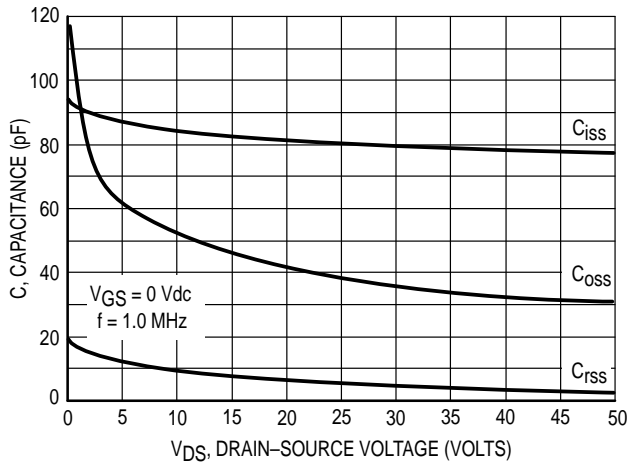

Figure 10. Capacitance versus Voltage

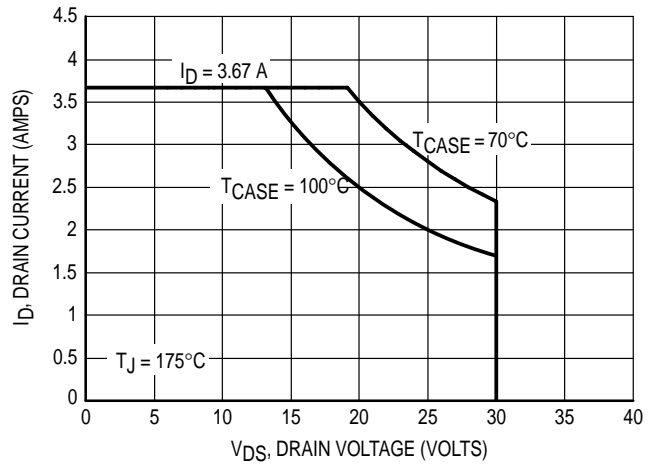

Figure 11. Class A Safe Operating Region

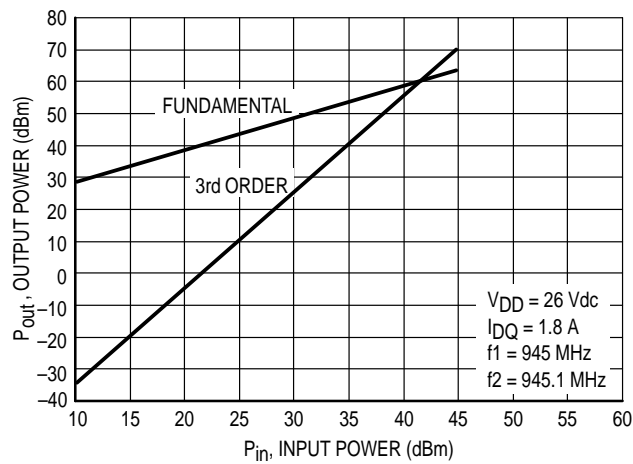

Figure 12. Class A Third Order Intercept Point

### TYPICAL CHARACTERISTICS

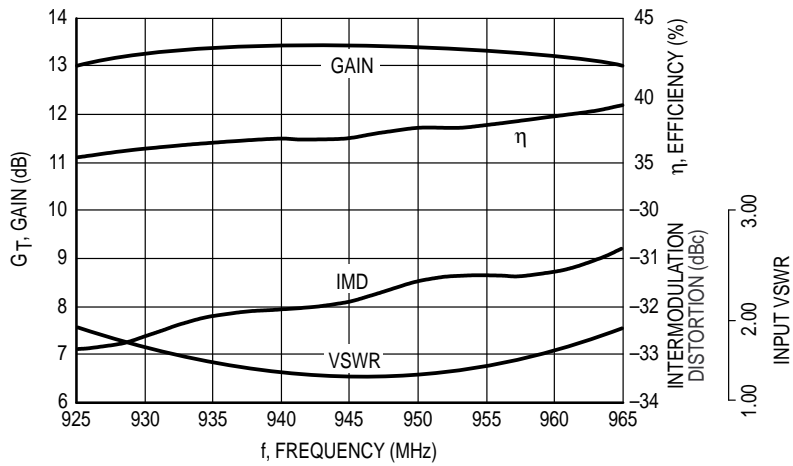

Figure 13. Broadband Power Performance of MRF183S

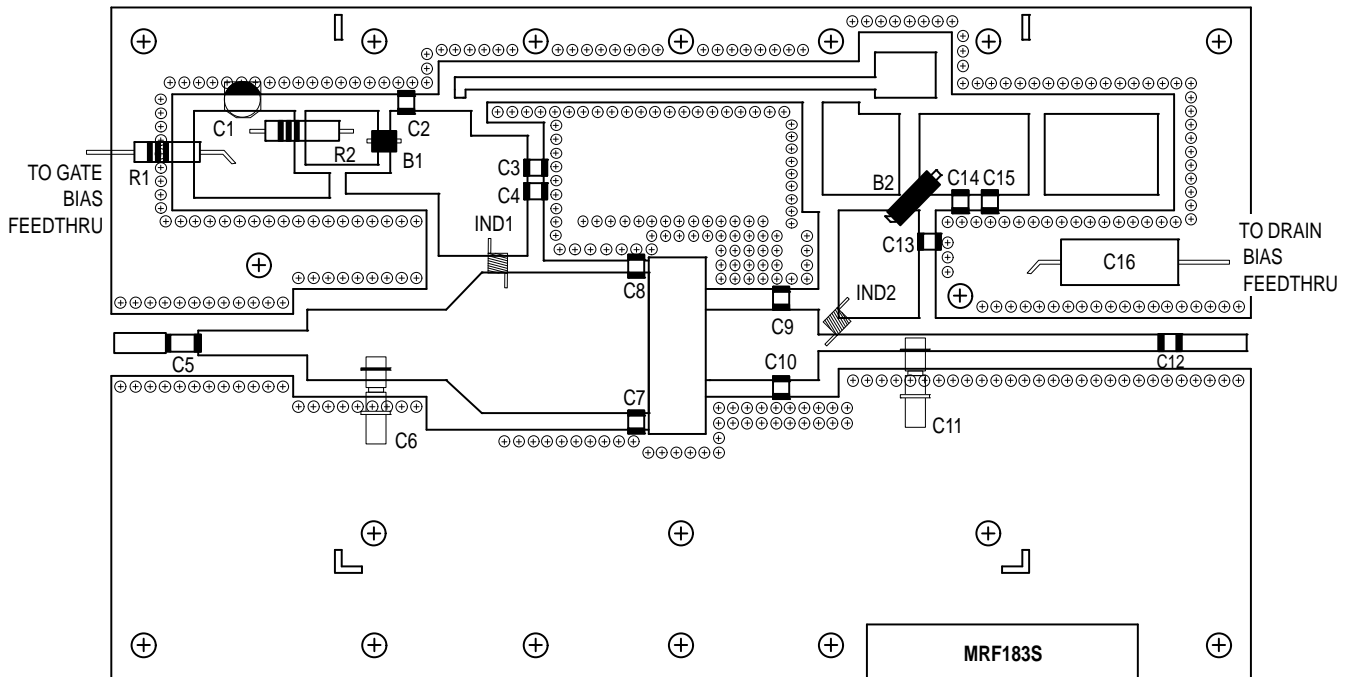
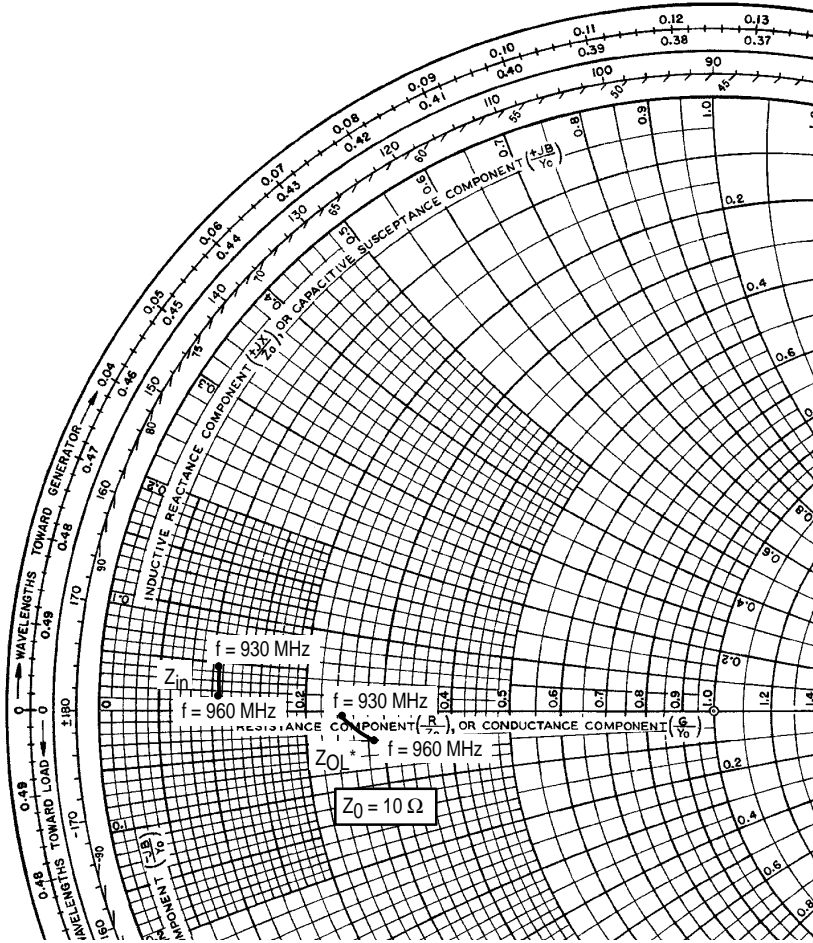

Figure 14. MRF183S Two Tone Test Circuit Component Parts Layout



$V_{DD} = 28\text{ V}$ ,  $I_{DQ} = 250\text{ mA}$ ,  $P_{out} = 45\text{ W (PEP)}$

f MHz	$Z_{in}$ Ohms	$Z_{OL}^*$ Ohms
930	$1.10 + j0.93$	$2.60 - j0.13$
945	$1.10 + j0.78$	$2.70 - j0.28$
960	$1.10 + j0.60$	$2.80 - j0.42$

$Z_{in}$  = Conjugate of source impedance.

$Z_{OL}$  = Conjugate of the load impedance at given output power, voltage and current conditions.

Note:  $Z_{OL}^*$  was chosen based on tradeoffs between gain, output power, drain efficiency and intermodulation distortion.

**Figure 15. Series Equivalent Input and Output Impedance**

Table 1. Typical Common Source S-Parameters ( $V_{DS} = 13.5\text{ V}$ )

$I_D = 1.5\text{ A}$

f MHz	S <sub>11</sub>		S <sub>21</sub>		S <sub>12</sub>		S <sub>22</sub>	
	S <sub>11</sub>	∠φ	S <sub>21</sub>	∠φ	S <sub>12</sub>	∠φ	S <sub>22</sub>	∠φ
20	0.954	-157	29.58	100	0.017	11	0.778	-161
30	0.941	-164	19.73	96	0.017	8	0.796	-168
40	0.922	-168	14.84	93	0.017	4	0.804	-170
50	0.907	-171	11.94	91	0.017	3	0.808	-172
60	0.903	-172	9.75	89	0.017	2	0.812	-173
70	0.899	-173	8.34	88	0.017	0	0.814	-174
80	0.898	-174	7.29	86	0.017	-1	0.816	-175
90	0.896	-175	6.49	85	0.017	-2	0.816	-175
100	0.897	-175	5.83	84	0.017	-2	0.817	-175
150	0.895	-177	3.82	79	0.017	-6	0.822	-176
200	0.898	-178	2.84	74	0.016	-9	0.828	-176
250	0.902	-178	2.24	70	0.016	-11	0.835	-176
300	0.908	-179	1.84	66	0.015	-14	0.842	-176
350	0.905	-179	1.55	62	0.015	-16	0.850	-176
400	0.913	-180	1.32	58	0.014	-18	0.861	-176
450	0.920	180	1.15	54	0.014	-18	0.865	-176
500	0.924	179	1.01	51	0.013	-20	0.874	-177
550	0.922	179	0.89	47	0.013	-21	0.881	-177
600	0.931	178	0.80	44	0.012	-21	0.889	-177
650	0.935	178	0.72	41	0.011	-20	0.895	-177
700	0.935	177	0.64	38	0.011	-17	0.901	-178
750	0.937	177	0.59	37	0.012	-18	0.905	-178
800	0.940	176	0.54	33	0.012	-20	0.913	-178
850	0.943	176	0.50	30	0.012	-29	0.919	-179
900	0.945	175	0.46	28	0.010	-33	0.924	-179
950	0.947	174	0.43	26	0.009	-34	0.930	-180
1000	0.947	174	0.40	24	0.008	-29	0.935	180
1050	0.947	173	0.37	21	0.007	-24	0.939	179
1100	0.952	172	0.35	19	0.007	-19	0.944	179
1150	0.949	172	0.32	17	0.007	-17	0.948	178
1200	0.946	171	0.30	14	0.006	-16	0.948	177
1250	0.954	170	0.28	12	0.006	-13	0.953	177
1300	0.952	170	0.27	9	0.006	-12	0.950	176
1350	0.949	169	0.26	9	0.006	-10	0.951	176
1400	0.948	168	0.23	8	0.005	-7	0.953	175
1450	0.948	168	0.22	6	0.004	4	0.948	174
1500	0.940	167	0.21	4	0.004	19	0.944	174



Table 2. Typical Common Source S-Parameters ( $V_{DS} = 28\text{ V}$ )

$I_D = 1.5\text{ A}$

f MHz	S <sub>11</sub>		S <sub>21</sub>		S <sub>12</sub>		S <sub>22</sub>	
	S <sub>11</sub>	∠φ	S <sub>21</sub>	∠φ	S <sub>12</sub>	∠φ	S <sub>22</sub>	∠φ
20	0.968	-132	45.79	113	0.014	24	0.579	-145
30	0.953	-145	31.75	106	0.015	17	0.623	-157
40	0.921	-154	24.33	99	0.015	12	0.648	-161
50	0.904	-159	19.68	95	0.015	7	0.661	-164
60	0.898	-163	16.11	92	0.015	5	0.670	-166
70	0.890	-165	13.79	90	0.015	2	0.677	-167
80	0.886	-167	12.06	87	0.015	1	0.681	-168
90	0.886	-168	10.71	86	0.015	-1	0.684	-169
100	0.887	-169	9.61	84	0.015	-3	0.688	-169
150	0.886	-172	6.26	76	0.015	-9	0.706	-170
200	0.890	-174	4.59	69	0.014	-13	0.724	-170
250	0.898	-175	3.57	64	0.014	-17	0.744	-169
300	0.906	-176	2.88	59	0.013	-19	0.764	-169
350	0.908	-177	2.37	54	0.012	-23	0.785	-169
400	0.915	-178	2.00	49	0.011	-24	0.807	-170
450	0.924	-178	1.71	45	0.010	-25	0.821	-170
500	0.930	-179	1.48	41	0.010	-26	0.838	-171
550	0.928	-180	1.28	37	0.009	-26	0.851	-171
600	0.937	180	1.13	33	0.008	-25	0.865	-172
650	0.944	179	1.00	30	0.007	-22	0.878	-172
700	0.943	178	0.88	27	0.008	-14	0.888	-173
750	0.946	178	0.81	25	0.008	-15	0.895	-173
800	0.949	177	0.73	22	0.009	-17	0.906	-174
850	0.954	177	0.67	20	0.009	-28	0.912	-175
900	0.953	175	0.61	18	0.007	-34	0.919	-175
950	0.957	175	0.56	15	0.005	-32	0.927	-176
1000	0.957	174	0.51	13	0.004	-22	0.934	-177
1050	0.957	174	0.48	10	0.004	-11	0.939	-178
1100	0.962	173	0.45	8	0.004	-2	0.945	-178
1150	0.959	172	0.41	7	0.004	3	0.950	-179
1200	0.955	171	0.39	4	0.004	9	0.950	-180
1250	0.962	170	0.36	2	0.004	13	0.955	180
1300	0.959	170	0.33	0	0.004	17	0.953	179
1350	0.956	169	0.31	-1	0.004	25	0.954	178
1400	0.954	168	0.29	-4	0.004	32	0.957	177
1450	0.955	168	0.28	-6	0.004	46	0.952	177
1500	0.948	167	0.26	-7	0.004	56	0.948	176

## PACKAGE DIMENSIONS

**CASE 360B-01  
ISSUE O  
(MRF183)**

NOTES:  
1. DIMENSIONING AND TOLERANCING PER ANSI Y14.5M, 1982.  
2. CONTROLLING DIMENSION: INCH.

DIM	INCHES		MILLIMETERS	
	MIN	MAX	MIN	MAX
A	0.790	0.810	20.07	20.57
B	0.220	0.240	5.59	6.09
C	0.125	0.175	3.18	4.45
D	0.205	0.225	5.21	5.71
E	0.050	0.070	1.27	1.77
F	0.004	0.006	0.11	0.15
G	.562 BSC		14.27 BSC	
H	0.070	0.090	1.78	2.29
K	0.215	0.255	5.47	6.47
N	0.350	0.370	8.89	9.39
Q	0.120	0.140	3.05	3.55

STYLE 1:  
PIN 1. DRAIN  
2. GATE  
3. SOURCE

**CASE 360C-03  
ISSUE B  
(MRF183S)**

NOTES:  
1. DIMENSIONING AND TOLERANCING PER ANSI Y14.5M, 1982.  
2. CONTROLLING DIMENSION: INCH.

DIM	INCHES		MILLIMETERS	
	MIN	MAX	MIN	MAX
A	0.370	0.390	9.40	9.91
B	0.220	0.240	5.59	6.09
C	0.105	0.155	2.67	3.94
D	0.205	0.225	5.21	5.71
E	0.035	0.045	0.89	1.14
F	0.004	0.006	0.11	0.15
H	0.057	0.067	1.45	1.70
K	0.085	0.115	2.16	2.92
N	0.350	0.370	8.89	9.39

STYLE 1:  
PIN 1. DRAIN  
2. GATE  
3. SOURCE

Motorola reserves the right to make changes without further notice to any products herein. Motorola makes no warranty, representation or guarantee regarding the suitability of its products for any particular purpose, nor does Motorola assume any liability arising out of the application or use of any product or circuit, and specifically disclaims any and all liability, including without limitation consequential or incidental damages. "Typical" parameters which may be provided in Motorola data sheets and/or specifications can and do vary in different applications and actual performance may vary over time. All operating parameters, including "Typicals" must be validated for each customer application by customer's technical experts. Motorola does not convey any license under its patent rights nor the rights of others. Motorola products are not designed, intended, or authorized for use as components in systems intended for surgical implant into the body, or other applications intended to support or sustain life, or for any other application in which the failure of the Motorola product could create a situation where personal injury or death may occur. Should Buyer purchase or use Motorola products for any such unintended or unauthorized application, Buyer shall indemnify and hold Motorola and its officers, employees, subsidiaries, affiliates, and distributors harmless against all claims, costs, damages, and expenses, and reasonable attorney fees arising out of, directly or indirectly, any claim of personal injury or death associated with such unintended or unauthorized use, even if such claim alleges that Motorola was negligent regarding the design or manufacture of the part. Motorola and are registered trademarks of Motorola, Inc. Motorola, Inc. is an Equal Opportunity/Affirmative Action Employer.

Mfax is a trademark of Motorola, Inc.

**How to reach us:**

**USA/EUROPE/Locations Not Listed:** Motorola Literature Distribution;  
P.O. Box 5405, Denver, Colorado 80217. 1-303-675-2140 or 1-800-441-2447

**JAPAN:** Nippon Motorola Ltd.: SPD, Strategic Planning Office, 4-32-1,  
Nishi-Gotanda, Shinagawa-ku, Tokyo 141, Japan. 81-3-5487-8488

**Customer Focus Center: 1-800-521-6274**

**Mfax™:** RMFA00@email.sps.mot.com – TOUCHTONE 1-602-244-6609  
Motorola Fax Back System – US & Canada ONLY 1-800-774-1848  
– http://sps.motorola.com/mfax/

**ASIA/PACIFIC:** Motorola Semiconductors H.K. Ltd.; 8B Tai Ping Industrial Park,  
51 Ting Kok Road, Tai Po, N.T., Hong Kong. 852-26629298

**HOME PAGE:** <http://motorola.com/sps/>

