

PRELIMINARY
 Notice ; This is not a final specification.
 some parametric limits are subject to change.

MITSUBISHI SOUND PROCESSORS

ICs

M65575FP

Rhythm Phrase Player

1. DESCRIPTION

The M65575FP is suitable for rhythm phrase reproduce LSI thanks to the internal music sources and rhythm patterns.

The M65575FP contains music sources which maximum counts are 256, also contains rhythm patterns which maximum counts are 64.

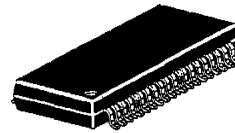

Outline 36P2R-A

0.8mm pitch 450mil SSOP
 (8.4mmx15.0mmx2.0mm)

2. FEATURES

[MUSIC SOURCE]	FEATURES
Compression algorithm	4 Bit ADPCM
Maximum music sources	256
Sampling frequency	4 KHz/8 KHz/16 KHz/32 KHz
Pronunciation counts	3 tracks (Monaural ; at the same time)
[Rhythm]	
Maximum rhythm patterns	64 patterns
Tempo	60 - 240 step 1
Resolution ratio	16 Beat
[System]	
Power Supply	3.3V Single power supply
Output	Stereo(L/R) Capable of both setting GAIN and Attenuate ATT ;0 dB ,-6 dB,-12 dB,-18 dB,-24 dB,-30 dB,-36 dB, -∞dB GAIN;6.0 dB,5.5 dB,4.9 dB,4.2 dB,3.5 dB,2.8 dB,1.9 dB,1.0dB
Pan pot	Capable of set each music sources of rhythm patterns (11steps)
Level	Capable of set each music sources of rhythm patterns (0dB,-6.0dB,-9.3dB,-12dB,-15.3dB,-21.3dB, - dB)
Music sources ROM size	1.5M Bit
Rhythm patterns ROM size	96K Bit
MCU I/F	4 line serial bus interface (clock,data,ratch,read/write)
MCU Commands	Tempo, Rhythm pattern setting, ATT setting, Start, Repeat start, Stop, PAD commands
[Internal function]	
Fs conversion filter	Input : 4 KHz/8 KHz/16 KHz/32 KHz Output : 32KHz
D/A converter	D/A converter 1 Bit converter (PWM output)

M65575FP Block Diagram

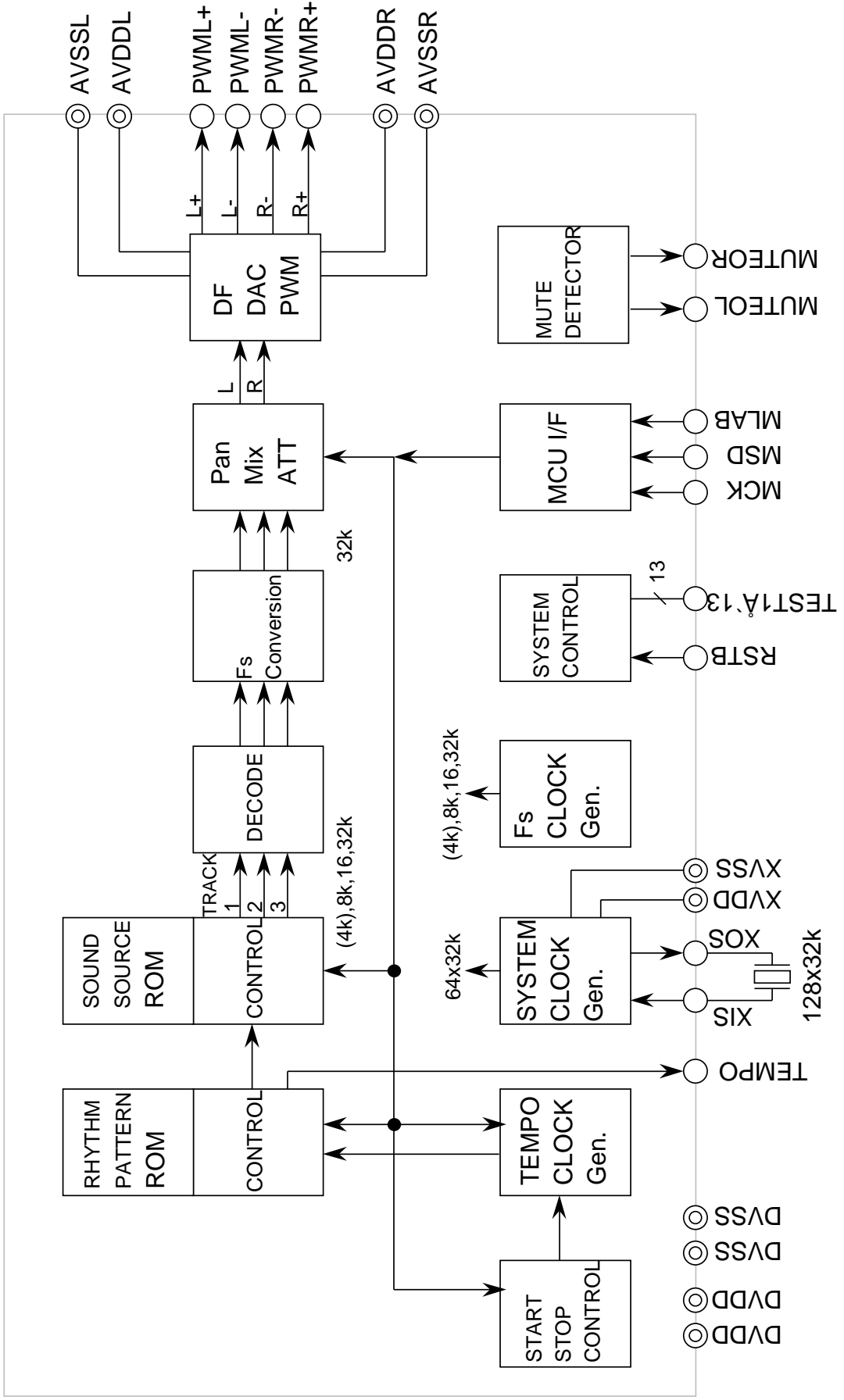

Pin Configuration

TEST1	1	36	DVDD
TEST2	2	35	MUTEOL
TEST3	3	34	TEST13
TEST4	4	33	PWML+
DVSS	5	32	AVSSL
MCK	6	31	PWML-
MSD	7	30	AVDDL
MLAB	8	29	XVSS
RSTB	9	28	XIS
TEST5	10	27	XOS
TEMPO	11	26	XVDD
TEST6	12	25	AVDDR
TEST7	13	24	PWMR-
DVDD	14	23	AVSSR
TEST8	15	22	PWMR+
TEST9	16	21	TEST12
TEST10	17	20	MUTEOR
TEST11	18	19	DVSS

MCU Command

1. Input timing chart

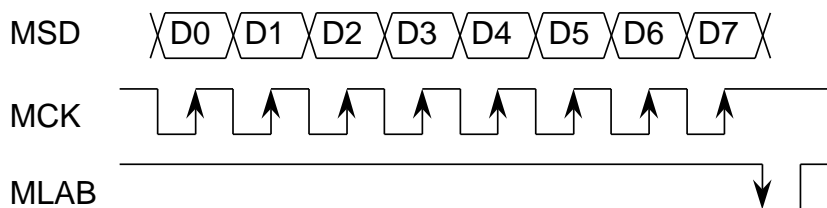

2. Data format

There are two setting bytes with MCU commands that are 1 Byte Command and 2 Byte Command.

Following are data formats of MCU command.

<1 Byte Command>

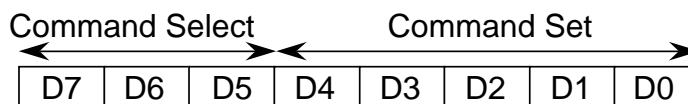

<2 Byte Command>

When using the 2 Byte Command, please send 1st byte at first and after, send 2nd byte.

1st Byte



2nd Byte

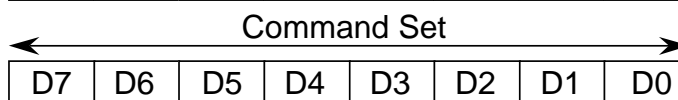

3. Command Settings

<Parameter set>

No.	Command	Function	Byte Counts
(1)	Tempo	Tempo setting Normal:60~160 step 1 Triplet tempo :90~240 step 1	2
(2)	Rhythm pattern select A	Presetting the rhythm pattern from the internal 64 (MAX) rhythm pattern. Capable of presetting 3 patterns (A,B,C)	2
(3)	Rhythm pattern select B		
(4)	Rhythm pattern select C		
(5)	Gain/Attenuate level control	Gain/Attenuate level setting 6.0,5.5,4.9,4.2,3.5,2.8,1.9,1.0, 0,-6,-12,-18,-24,-30,-36,- dB	1

<Start/Stop/Pad Control set>

No.	Command	Function	Byte Counts
(6)	Start/Stop control	Rhythm start/stop control	1
(7)	PAD control	PAD control (2 systems)	2

<Software reset / Test Control set>

No.	Command	Function	Byte Counts
(8)	Reset/Test	Software reset, Test mode (shipment test)	1

4. Command Function Explanations

(1)Tempo

() at the first setting mode

Command	Byte No.	Bit allotment							
		D7	D6	D5	D4	D3	D2	D1	D0
Tempo	1	L	L	L	don't care				
	2	tempo[7:0] (LHLLHLL)							

- tempo[7:0] : Tempo setting is following.
 Normal 3C-A0(Hex) [60-160(Dec)]
 Triplet tempo 5A-F0(Hex) [90-240(Dec)]
 (Cannot use another settings)
 Capable of the setting 1 step unit.
 At the first setting is 64(Hex) [120(Dec)].

(2)Rhythm pattern select A

(3)Rhythm pattern select B

(4)Rhythm pattern select C

() at the first setting mode

Command	Byte No.	Bit allotment							
		D7	D6	D5	D4	D3	D2	D1	D0
Rhythm pattern select A	1	L	L	H	don't care				
	2	don't care		rhythm_pat_sel_a[5:0] (LLLLLL)					
Rhythm pattern select B	1	L	H	L	don't care				
	2	don't care		rhythm_pat_sel_b[5:0] (LLLLLL)					
Rhythm pattern select C	1	L	H	H	don't care				
	2	don't care		rhythm_pat_sel_c[5:0] (LLLLLL)					

- rhythm_pat_sel_a[5:0] : Setting the Rhythm pattern A
- rhythm_pat_sel_b[5:0] : Setting the Rhythm pattern B
- rhythm_pat_sel_c[5:0] : Setting the Rhythm pattern C

You can set the each rhythm pattern (A,B,C) and choose 64 internal patterns (Maximum).

One of these rhythm pattern start the play, after you choose one of them and send the start/stop control commands.

(5)Attenuate level

() at the first setting mode

Command	Byte No.	Bit allotment							
		D7	D6	D5	D4	D3	D2	D1	D0
Attenuate level	1	H	L	L	don't care		att[2:0] (LLL)		

- att[2:0] : Setting the output attenuate level.
It sets common setting with Lch and Rch.

Attenuate level control

att [2] [1] [0]	Attenuate level[dB]
L L L	0
L L H	-6
L H L	-12
L H H	-18
H L L	-24
H L H	-30
H H L	-36
H H H	-

(6)Start/Stop Control

() at the first setting mode

Command	Byte No.	Bit allotment							
		D7	D6	D5	D4	D3	D2	D1	D0
Start/Stop Control	1	H	L	H	pat_sel[1:0] (LL)		start (L)	s_mode (L)	e_mode (L)

Start/stop control command control the rhythm music start/stop timing.

- pat_sel[1:0] : Select the rhythm pattern (A,B or C)
It can select the next rhythm music from rhythm pattern A,B or C.
Rhythm pattern select mode

pat_sel [1] [0]	Rhythm Pattern Select
L L	Rhythm Pattern A
L H	Rhythm Pattern B
H L	Rhythm Pattern C
H H	Prohibit

- start : Control the start/stop timing of rhythm music.
H;Start the rhythm music L;Stop the music without delay
- s_mode : Setting the start mode of rhythm music
H; Chain music Start (Start the music after ending the before music)
L; Start music without delay
- e_mode : Setting the stop mode of rhythm music
H;Loop reproduction mode (music continuous mode)
L;1 shot reproduction mode (1 time mode)

Thanks to these commands, we can control the following rhythm play mode.

Rhythm controls have two modes,

- One shot start mode and loop start mode which start when the rhythm music is not available
- Chain start, start without delay and stop without delay which control when the rhythm music is playing

Following is an example of rhythm play mode. (of course you can use all pattern A,B,C)

<Rhythm control when the rhythm music is not available>

1 shot start : Reproduce the rhythm music once a time

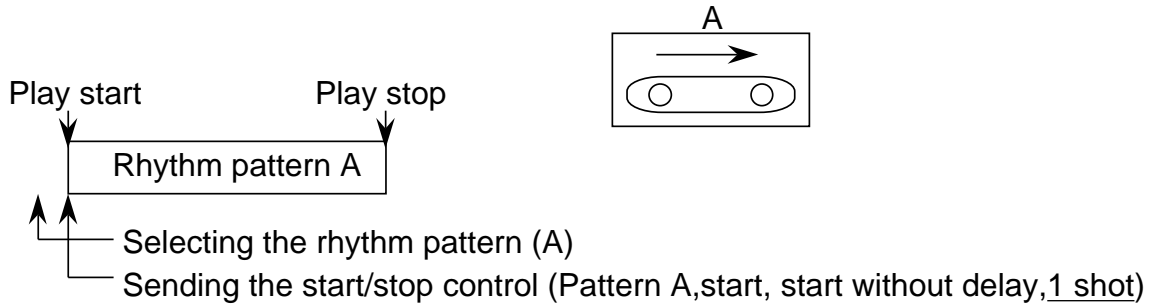

Loop start : Reproduce the rhythm music repeatedly

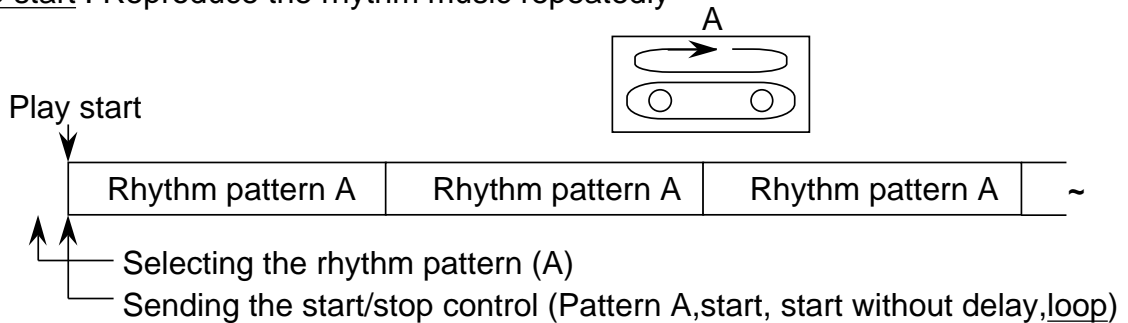

<Rhythm control when the rhythm music is playing>

Chain Start(1 shot 1 shot)

: Reproduce the two rhythm patterns (1shot) and connecting one and another patterns

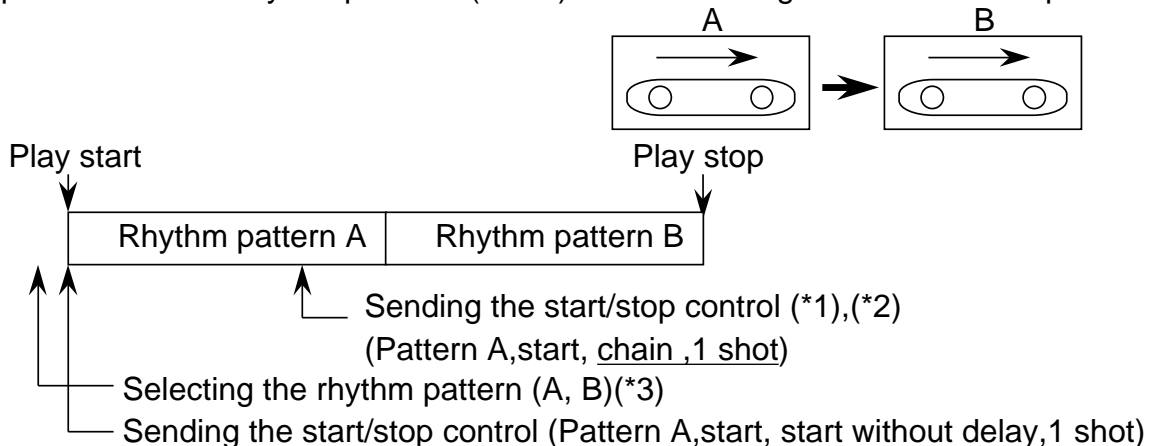

(*1)Please send the control mode before the end of rhythm pattern A

(*2)If you resend the start/stop command before the start of rhythm pattern B, executed the newest control command.

(*3)Please preset the rhythm pattern select (B) like that, or preset before sending the rhythm pattern B control command.

Chain start(1 shot loop)

: Reproduce the rhythm patterns that connecting one shot and loop rhythm pattern.

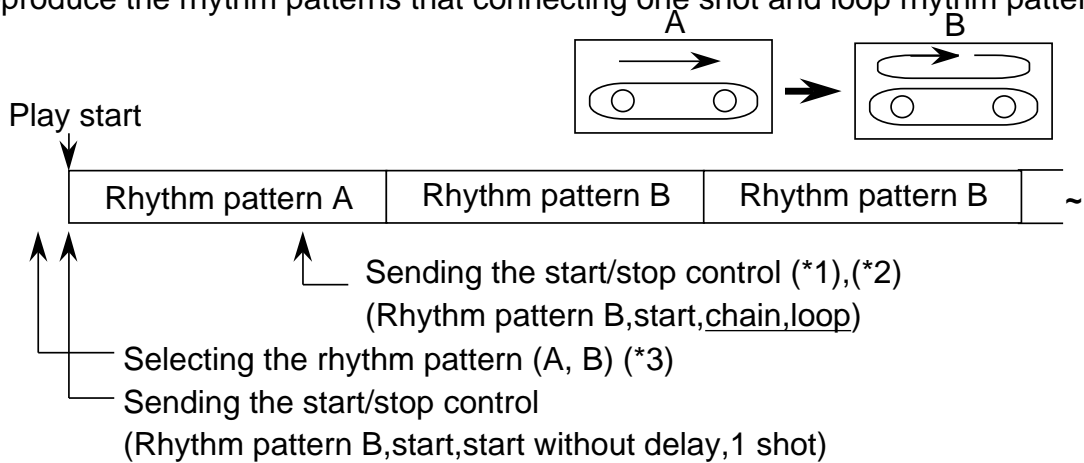

Chain start(loop 1 shot)

: Reproduce the rhythm patterns that connecting loop and 1 shot rhythm pattern.

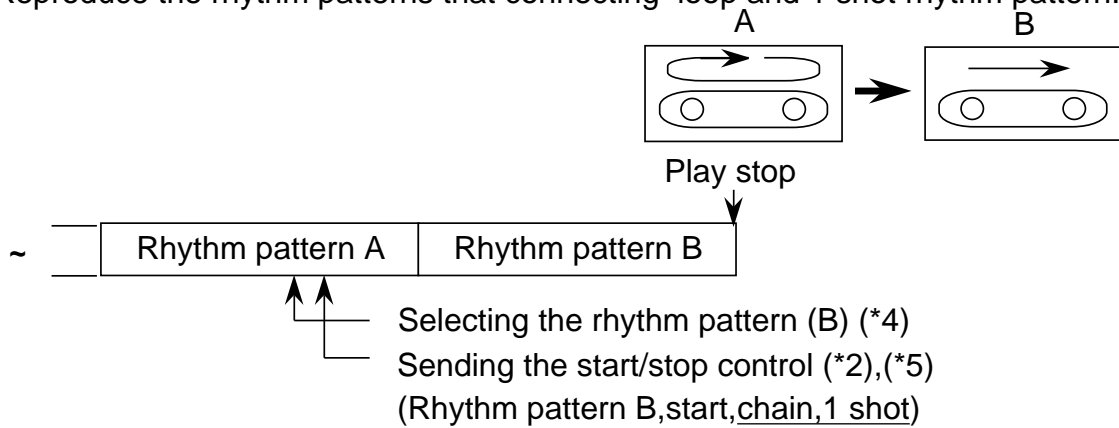

(*4)Please send the rhythm pattern B command before sending the start/stop control pattern B (Can be set the preset)

(*5) After end of the rhythm pattern A music,please start the play of rhythm pattern B.

Chain start(loop loop)

: Reproduce the rhythm patterns that connecting loop and another loop rhythm pattern.

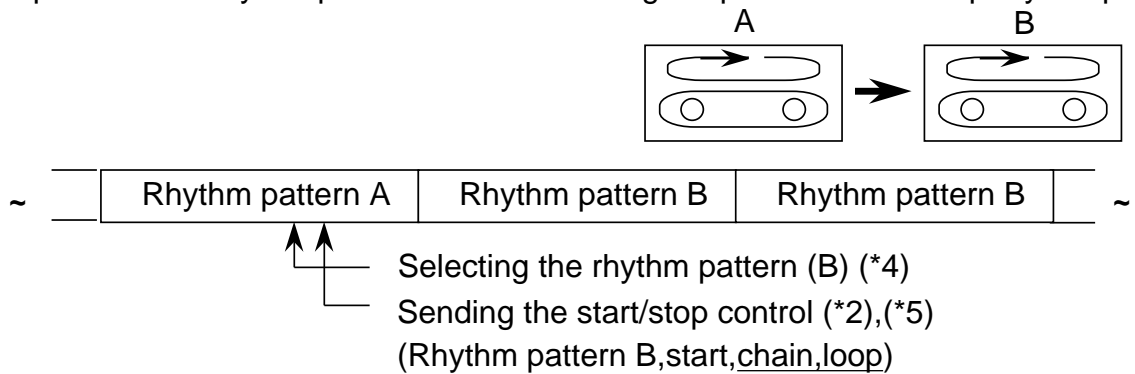

Start without delay : Stopping the rhythm music play without delay , and starting another rhythm music without delay

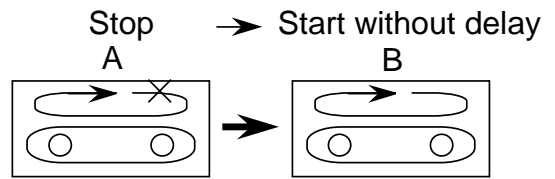

Stopping the rhythm pattern A play,
and starting the rhythm pattern B without delay

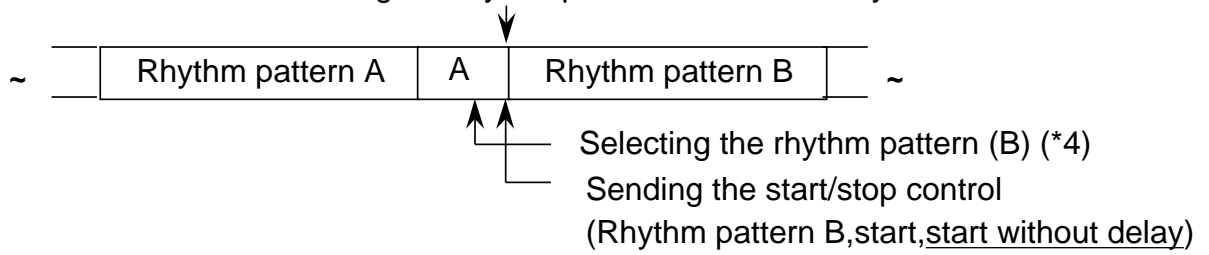

Stop without delay : Stopping the rhythm music without delay

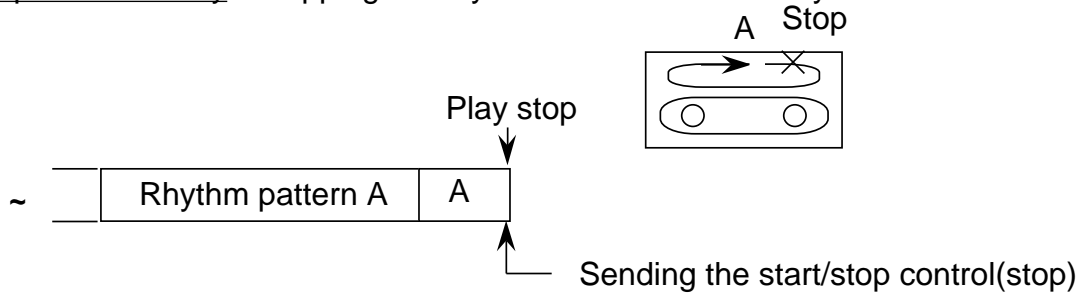

(7) PAD control

() at the first setting mode

Command	Byte No.	Bit allotment							
		D7	D6	D5	D4	D3	D2	D1	D0
PAD control	1	H	H	L	don't care			pad2o (L)	pad1o (L)
	2	pad_sel2[3:0] (LLLL)				pad_sel1[3:0] (LLLL)			

PAD control command can set the 2 units (PAD1 and PAD2) control.

- pad1o : Control command of PAD1
H;Output the PAD1 music source L;Don't care
- pad2o : Control command of PAD2
H;Output the PAD2 music source L;Don't care
- pad_sel[3:0] : Select the PAD1,2 music sources
Following is the contents of music source select.
* Music source details are under consideration

pad_sel1[3:0] [3] [2] [1] [0]	PAD1	pad_sel2[3:0] [3] [2] [1] [0]	PAD2
L L L L	music source 0	L L L L	music source 0
L L L H	music source 1	L L L H	music source 1
L L H L	music source 2	L L H L	music source 2
L L H H	music source 3	L L H H	music source 3
L H L L	music source 4	L H L L	music source 4
L H L H	music source 5	L H L H	music source 5
L H H L	music source 6	L H H L	music source 6
L H H H	music source 7	L H H H	music source 7
H L L L	music source 8	H L L L	music source 8
H L L H	music source 9	H L L H	music source 9
H L H L	music source 10	H L H L	music source 10
H L H H	music source 11	H L H H	music source 11
H H L L	music source 12	H H L L	music source 12
H H L H	music source 13	H H L H	music source 13
H H H L	music source 14	H H H L	music source 14
H H H H	music source 15	H H H H	music source 15

(8) RESET/TEST

() at the first setting mode

Command	Byte No.	Bit allotment							
		D7	D6	D5	D4	D3	D2	D1	D0
RESET/Test	1	H	H	H	sreset (L)	test[3:0] (LLLL)			

- sreset : Setting the software reset control.
H; system reset mode (L ; not use)
- test[3:0] : This setting use only shipment test.
Normal mode setting is "LLLL" *Please don't use another setting

(9) Summary of Command bits

() at the first setting mode

Command	Byte No.	Bit allotment							
		D7	D6	D5	D4	D3	D2	D1	D0
Tempo	1	L	L	L	don't care				
	2	tempo[7:0] (LHHLLHLL)							
Rhythm pattern select A	1	L	L	H	don't care				
	2	don't care		rhythm_pat_sel_a[5:0] (LLLLLL)					
Rhythm pattern select B	1	L	H	L	don't care				
	2	don't care		rhythm_pat_sel_b[5:0] (LLLLLL)					
Rhythm pattern select C	1	L	H	H	don't care				
	2	don't care		rhythm_pat_sel_c[5:0] (LLLLLL)					
Attenuate level	1	H	L	L	don't care	att[3:0] (LLLL)			
Start/stop control	1	H	L	H	pat_sel[1:0] (LL)	start (L)	s_mode (L)	e_mode (L)	
PAD control	1	H	H	L	don't care		pad1o (L)	pad2o (L)	
	2	pad_sel2[3:0] (LLLL)			pad_sel1[3:0] (LLLL)				
Reset/Test	1	H	H	H	sreset (L)	test[3:0] (LLLL)			