

# New Product Announcement

## 8 & 16 Amp Schottky Rectifiers

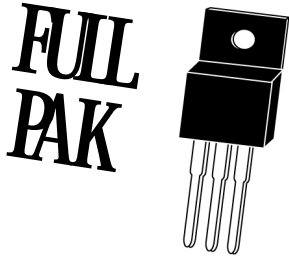

in a  
**TO-220FP**  
package

Sample Devices  
available  
upon request.

### Features

- Fully isolated tab eliminates need for additional insulation on circuit board.
- Available in both single and dual (common cathode) configurations.
- Also available in Surface Mount packages.

### Rectifiers, Schottky

8.0 to 16 Amperes  
40 to 100 Volts

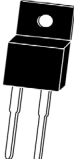
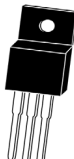
I <sub>O</sub> (AMPS)	8.0	16
@ T <sub>C</sub> (°C)	100	90
I <sub>FSM</sub> (AMPS)	150	150
	 SINGLE	 DUAL
V <sub>RRM</sub> (Volts)		
40	CRSH-40FP	CRSH16-40FP
60	CSHDD8-60FP	CRSH16-60FP
100	CSHDD8-100FP	CRSH16-100FP
V <sub>F</sub> MAX @ I <sub>F</sub> = I <sub>O</sub> @ T <sub>C</sub> = 125°C		
40V	0.57V	0.72V
60V	0.65V	0.85V
100V	0.75V	1.00V

### Rectifiers, Ultra Fast

8.0 to 16 Amperes  
200 to 800 Volts

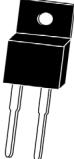
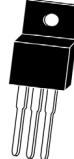
I <sub>O</sub> (AMPS)	8.0	16
@ T <sub>A</sub> (°C)	25	25
I <sub>FSM</sub> (AMPS)		
	 SINGLE	 DUAL
V <sub>RRM</sub> (Volts)		
200	CR8U-02FP	CR16UD-02FP
400	CR8U-04FP	CR16UD-04FP
800	CR8U-08FP	CR16UD-08FP

V <sub>F</sub> MAX @ I <sub>F</sub> = I <sub>O</sub> @ T <sub>C</sub> = 150°C		
200V	0.895V	0.895V @ 8.0A
400V	1.1V	1.1V @ 8.0A
800V	1.2V	1.2V @ 8.0A

I <sub>R</sub> MAX @ V <sub>RRM</sub>	5.0µA*	5.0µA *
t <sub>rr</sub> (200V)	25 ns	25 ns
t <sub>rr</sub> (400V)	25 ns	25 ns
t <sub>rr</sub> (800V)	50 ns	50 ns

\* 200 Volt device

**Central**<sup>TM</sup>  
**Semiconductor Corp.**

145 Adams Avenue, Hauppauge, New York 11788 USA  
Tel: (631) 435-1110 • Fax: (631) 435-1824  
www.centrasemi.com

# Schottky & Ultra Fast Rectifiers TO-220FP

All Dimensions in inches (mm).

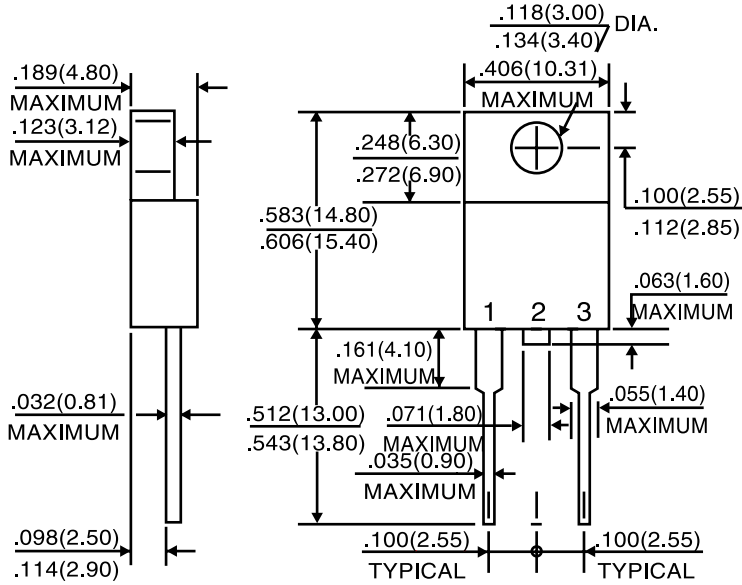

LEAD CODE:  
1) CATHODE  
2) ANODE

All Dimensions in inches (mm).

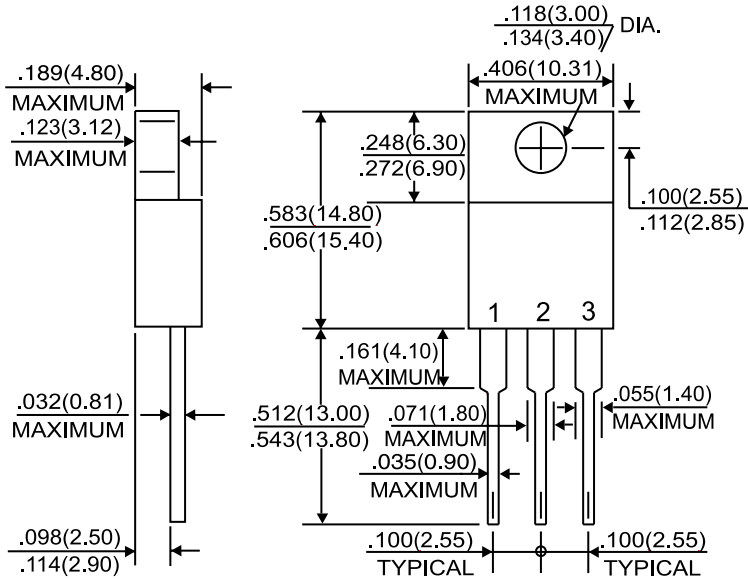

LEAD CODE:  
1) ANODE#1  
2) CATHODE  
3) ANODE #2

**Central**™  
**Semiconductor Corp.**

Dedicated to Complete Customer Satisfaction

145 Adams Avenue  
Hauppauge, NY 11788 USA  
Phone (631) 435-1110  
Fax (631) 435-1824  
[www.centalsemi.com](http://www.centalsemi.com)  
PA TO-220FP