

PA74/76 • PA74A/76A

FEATURES

- LOW COST
- WIDE COMMON MODE RANGE — Includes negative supply
- WIDE SUPPLY VOLTAGE RANGE
Single supply: 5V to 40V
Split supplies: $\pm 2.5V$ to $\pm 20V$
- HIGH EFFICIENCY — $|V_s - 2.2V|$ at 2.5A typ
- HIGH OUTPUT CURRENT — 3A
- LOW DISTORTION

APPLICATIONS

- HALF & FULL BRIDGE MOTOR DRIVERS
- AUDIO POWER AMPLIFIER
STEREO — 30W RMS per channel
BRIDGE — 60W RMS per package
- IDEAL FOR SINGLE SUPPLY SYSTEMS
5V — Peripherals, 12V — Automotive
28V — Avionic

DESCRIPTION

The amplifier design consists of dual monolithic input and output stages to achieve the desired input and output characteristics of the PA74 and PA76. The input stage utilizes a dual power op amp on a single chip monolithic that drives the output stages. The output stages are configured in a non inverting unity gain buffer configuration. The output stages of the amplifier are also compensated for stability. The PA74 and PA76 dual amplifiers are designed with both monolithic and hybrid technologies providing a cost effective solution for applications requiring multiple amplifiers per board or bridge mode configurations. Both amplifiers are internally compensated but are not recommended for use as unity gain followers.

This dual hybrid circuit utilizes a beryllia (BeO) substrate, thick film resistors, ceramic capacitors and monolithic amplifiers to maximize reliability and power handling capability, minimize size and give top performance. Ultrasonically bonded aluminum wires provide reliable interconnections at all operating temperatures. The 8-Pin TO-3 package is hermetically sealed and electrically isolated. The use of compressible isolation washers voids the warranty.

EQUIVALENT SCHEMATIC ONE CHANNEL

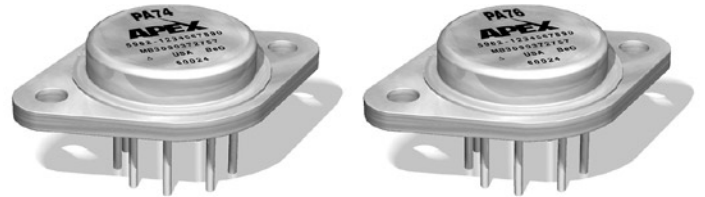
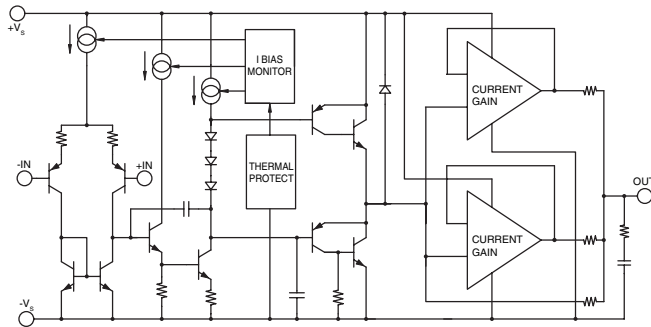

8-PIN TO-3
PACKAGE STYLE CE

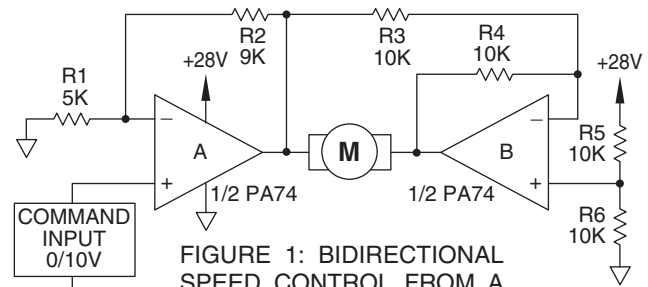

FIGURE 1: BIDIRECTIONAL SPEED CONTROL FROM A SINGLE SUPPLY.

TYPICAL APPLICATION

R1 and R2 set up amplifier A in a non-inverting gain of 2.8. Amp B is set up as a unity gain inverter driven from the output of amp A. Note that amp B inverts signals about the reference node, which is set at mid-supply (14V) by R5 and R6. When the command input is 5V, the output of amp A is 14V. Since this is equal to the reference node voltage, the output of amp B is also 14V, resulting in 0V across the motor. Inputs more positive than 5V result in motor current flow from left to right (see Figure 1). Inputs less positive than 5V drive the motor in the opposite direction.

The amplifiers are especially well-suited for this application. The extended common mode range allows command inputs as low as 0V. Its superior output swing abilities let it drive within 2V of supply at an output current of 2A. This means that a command input that ranges from 0.714V to 9.286V will drive a 24V motor from full scale CCW to full scale CW at up to $\pm 2A$. A single power op amp with an output swing capability of $V_s - 6$ would require $\pm 30V$ supplies and would be required to swing 48V p-p at twice the speed to deliver an equivalent drive.

EXTERNAL CONNECTIONS (TOP VIEWS)

PA74

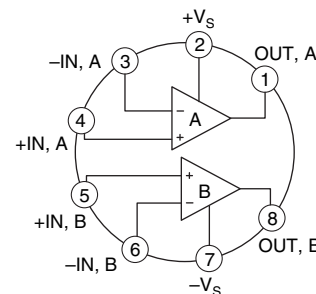

PA76

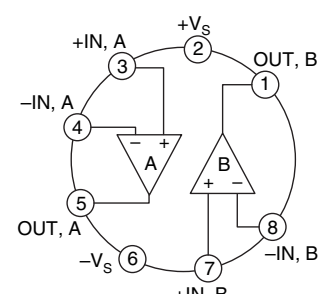

PA74/76 • PA74A/PA76A

ABSOLUTE MAXIMUM RATINGS
SPECIFICATIONS

ABSOLUTE MAXIMUM RATINGS

SUPPLY VOLTAGE, total	5V to 40V
OUTPUT CURRENT	SOA
POWER DISSIPATION, internal (per amplifier)	36W
POWER DISSIPATION, internal (both amplifiers)	60W
INPUT VOLTAGE, differential	$\pm V_S$
INPUT VOLTAGE, common mode	$+V_S, -V_S-0.5V$
JUNCTION TEMPERATURE, max ¹	150°C
TEMPERATURE, pin solder-10 sec max	300°C
TEMPERATURE RANGE, storage	-65°C to 150°C
OPERATING TEMPERATURE RANGE, case	-55°C to 125°C

SPECIFICATIONS

PARAMETER	TEST CONDITIONS ²	PA74/76			PA74A/PA76A			UNITS
		MIN	TYP	MAX	MIN	TYP	MAX	
INPUT								
OFFSET VOLTAGE, initial			1.5	10		.5	7	mV
OFFSET VOLTAGE, vs. temperature	Full temperature range		20			10		$\mu V/^\circ C$
BIAS CURRENT, initial			100	500		*	250	nA
COMMON MODE RANGE	Full temperature range	$-V_S$		$+V_S-1.3$	*		*	V
COMMON MODE REJECTION, DC	Full temperature range	60	70		*	*		dB
POWER SUPPLY REJECTION	Full temperature range	60	90		*	*		dB
CHANNEL SEPARATION	$I_{OUT} = 1A, F = 1kHz$	50	70		*	*		dB
INPUT NOISE VOLTAGE	$R_S = 100\Omega, f = 1 \text{ to } 100kHz$							
GAIN								
OPEN LOOP GAIN	Full temperature range	89	100		*	*	*	dB
GAIN BANDWIDTH PRODUCT	$A_V = 40dB$	0.9	1.4		*	*		MHz
POWER BANDWIDTH	$V_{O(P-P)} = 28V$		13.6			*		kHz
OUTPUT								
CURRENT, peak		2.5			3			A
SLEW RATE		0.5	1.4		*	*		V/ μs
VOLTAGE SWING	Full temp. range, $I_O = 100mA$	$ V_{S1} - 1.1$	$ V_{S1} - 0.9$		*	*		V
VOLTAGE SWING	Full temp. range, $I_O = 1A$	$ V_{S1} - 2.0$	$ V_{S1} - 1.7$		*	*		V
VOLTAGE SWING	$I_O = 2.5A$ (PA74, 76)	$ V_{S1} - 3.5$	$ V_{S1} - 2.9$		*	*		V
VOLTAGE SWING	$I_O = 3.0A$ (PA74A, PA76A)				$ V_{S1} - 4.0$	$ V_{S1} - 3.3$		V
POWER SUPPLY								
VOLTAGE, V_{SS} ³			30	40	*	*	*	V
CURRENT, quiescent, total			18	40		*	*	mA
THERMAL								
RESISTANCE, junction to case								
DC, single amplifier			3.2	3.5		*	*	$^\circ C/W$
DC, both amplifiers ⁴			1.9	2.1		*	*	$^\circ C/W$
AC, single amplifier			2.4	2.6		*	*	$^\circ C/W$
AC, both amplifiers ⁴			1.4	1.6		*	*	$^\circ C/W$
RESISTANCE, junction to air			30			*	*	$^\circ C/W$
TEMPERATURE RANGE, case	Meets full range specifications	-25		85	-25		85	$^\circ C$

NOTES: * The specification of PA74A/PA76A is identical to the specification for PA74/PA76 in applicable column to the left.

1. Long term operation at the maximum junction temperature will result in reduced product life. Derate internal power dissipation to achieve high MTTF.
2. Unless otherwise noted, the following conditions apply: $\pm V_S = \pm 15V, TC = 25^\circ C$.
3. $+V_S$ and $-V_S$ denote the positive and negative supply rail respectively. V_{SS} denotes the total rail-to-rail supply voltage.
4. Rating applies when power dissipation is equal in the two amplifiers.

CAUTION

The internal substrate contains beryllia (BeO). Do not break the seal. If accidentally broken, do not crush, machine, or subject to temperatures in excess of 850°C to avoid generating toxic fumes.

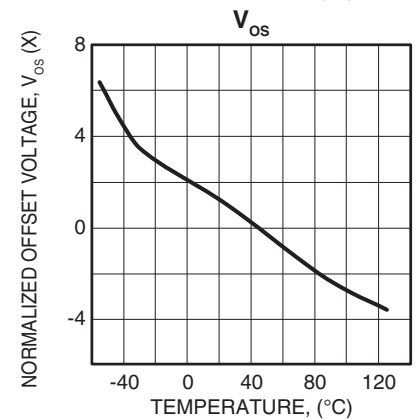
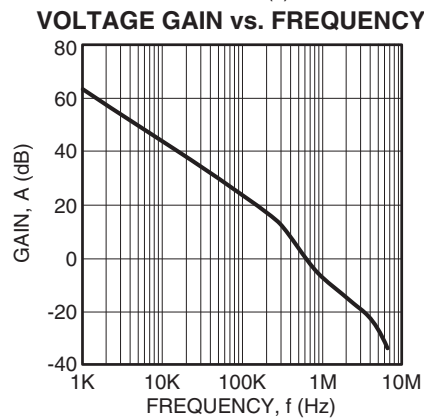
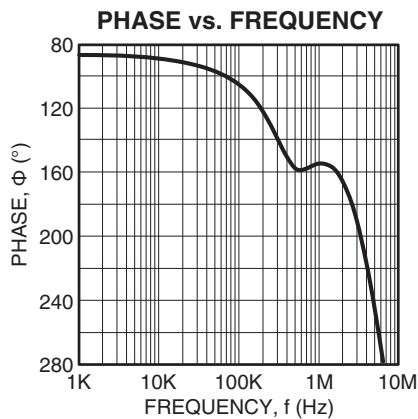
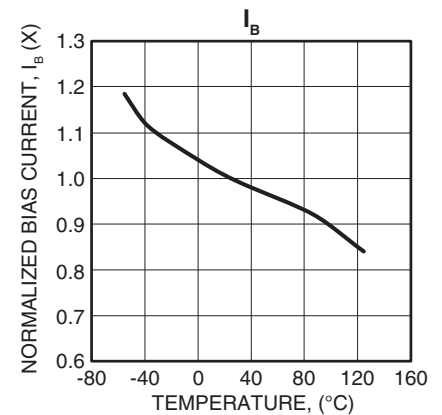
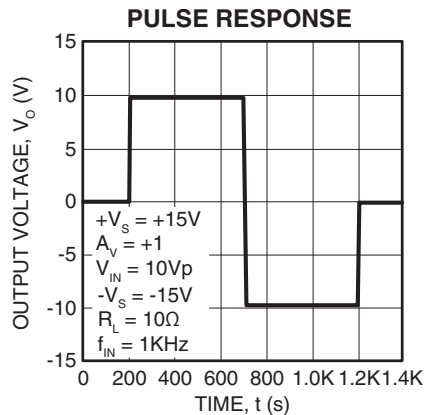
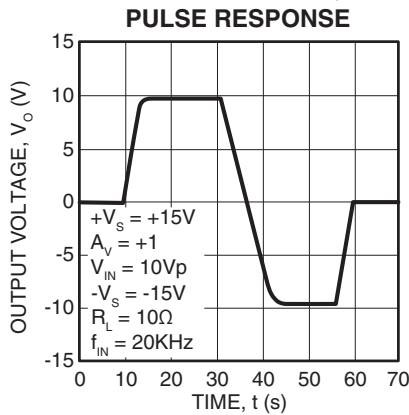
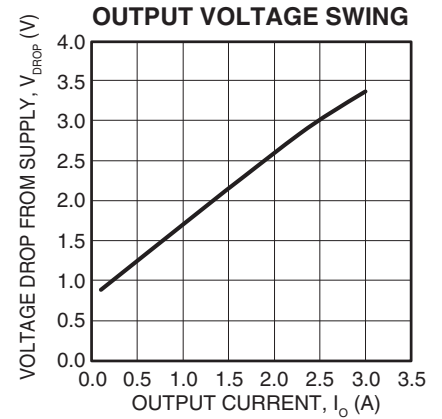
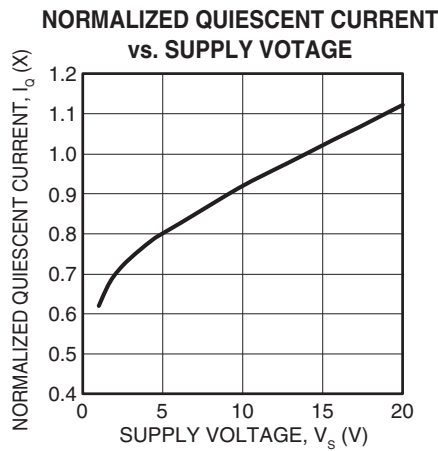
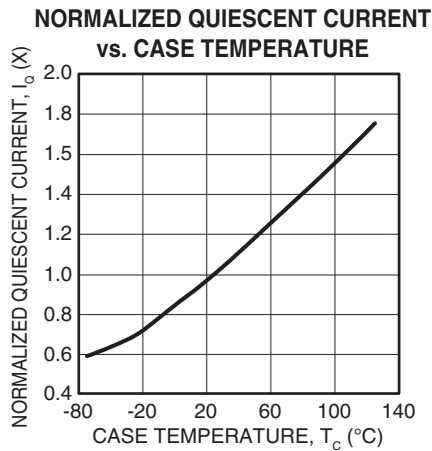

GENERAL

Please read Application Note 1 "General Operating Considerations" which covers stability, supplies, heatsinking, mounting, SOA interpretation, and specification interpretation. Visit www.apexmicrotech.com for design tools that help automate tasks such as calculations for stability, internal power dissipation, heatsink selection; Apex's complete Application Notes library; Technical Seminar Workbook; and Evaluation Kits.

STABILITY CONSIDERATIONS

All monolithic power op amps use output stage topologies that present special stability problems. This is primarily due to non-complementary (both devices are NPN) output stages with a mismatch in gain and phase response for different polarities of output current. It is difficult for the opamp manufacturer to optimize compensation for all operating conditions.

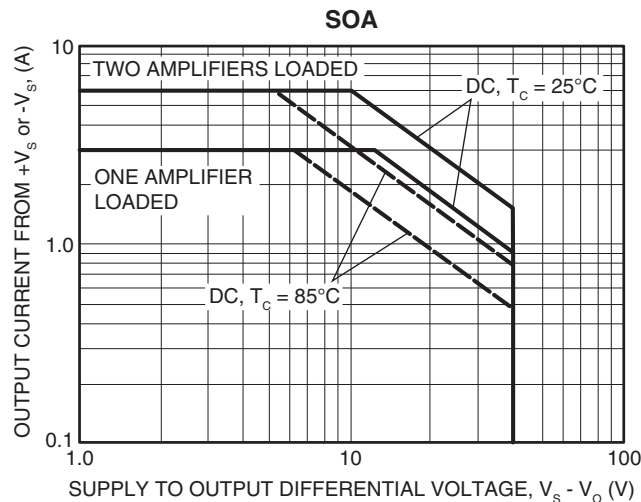

SAFE OPERATING AREA (SOA)

The SOA curves combine the effect of all limits for this power op amp. For a given application, the direction and magnitude of the output current should be calculated or measured and checked against the SOA curves. This is simple for resistive loads but more complex for reactive and EMF generating loads.

THERMAL CONSIDERATIONS

Thermal grease or an Apex TW03 thermal washer, $RCS = .1$ to $.2^\circ\text{C}/\text{W}$, is the only recommended interface for the PA74/76. Internal power dissipation increases directly with frequency therefore it is critical to sufficiently heat sink the PA74 and PA76. Even unloaded the PA74 and PA76 can dissipate up to 3 watts while running at higher frequencies.

PARALLEL CONFIGURATION CONSIDERATIONS LOSSES

The PA74 and PA76 utilize a parallel configuration to achieve the desired current output requirements. The parallel configuration inherently creates internal losses due to circulating currents. The circulating currents generate power losses through the current sharing resistors when delivering current to the load.

SUPPLY CURRENT

The parallel configuration used in the PA74 and PA76 also generates supply currents while high voltage sign waves are seen at the output. Listed below are the supply currents expected while running at a particular frequency and when $V_O \approx 15\text{Vpp}$, note that the outputs are not loaded.

Frequency	Supply Current
100Hz	18mA
1KHz	20mA
5KHz	32mA
10KHz	50mA
15KHz	75mA

SATURATION OPERATION

The parallel configuration used in the PA74 and PA76 is sensitive to operation in the saturation region. The PA74 and PA76 may exhibit large peak currents; this is mainly due to thermal protection limitations.

