

## FM ANTENNA DIVERSITY IC

The KIA2039FN is a antenna-switch type FM Antenna diversity IC developed for use in car tuners.

For diversity, all you need is this IC.

The FM IF diversity IC can be easily combined with RF processor KIA2074F and FM processor KIA2093F.

An excellent space factor and shrink package delivers diversity in the smallest possible space.

## FUNCTIONS

- Average electric field value and peak value comparison/detection (Advanced noise detector)
- Antenna switch control.
- Antenna switch driver.
- Antenna misoperation switching protector.
- Over-deviation protector.
- Protection against weak electric field misoperation.
- Strong electric field sub antenna fixed.
- Antenna switch mode switch.
- Operating power supply voltage :  $V_{CC}=7\sim 10V$ .

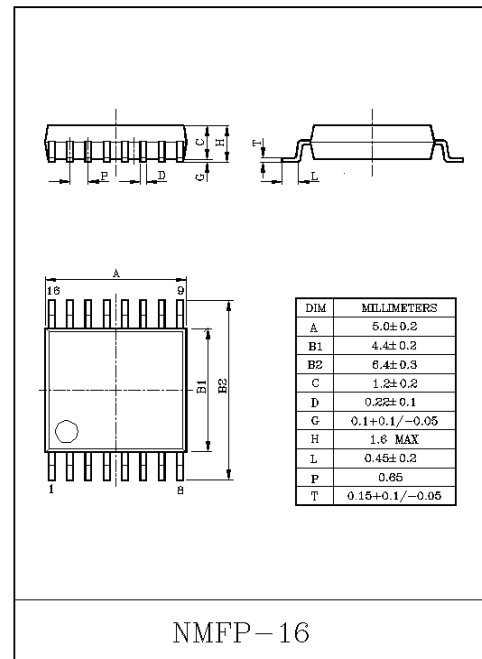

## FEATURES

- Uses a new method called advanced noise detection.  
This method detects the comparison of an electric field detect signal obtained by, for example, FM processor KIA2027F connected to the next step, with the average and peak values, then switches antennas based on the result. Thus, conventional external large-capacity capacitors using noise detect AGC (Automatic gain control) are no longer needed.
- The basic operation of the antenna diversity IC is that when noise is received from the currently-connected antenna, the IC switches to the other antenna.  
That is, the antenna with the best reception is not necessarily connected all the time. Therefore, to guard against possible misoperations, the following three functions are supported.
  - a. Antenna misoperation switching protector.
  - b. Over-deviation protector.
  - c. Weak electric field misoperation protector.
- The constants of external components have low values. Thus, all components can be integrated on a single 10×40mm printed circuit board.

# KIA2039FN

MAXIMUM RATINGS (Ta=25°C)

CHARACTERISTIC	SYMBOL	RATING	UNIT
Power Supply Voltage	V <sub>CC</sub>	10	V
Power Dissipation (Note)	P <sub>D</sub>	550	mW
Operating Temperature	T <sub>opr</sub>	-40~85	°C
Storage Temperature	T <sub>stg</sub>	-55~150	°C
Pins ⑨ and ⑩ Flow Current	I <sub>9</sub> , I <sub>10</sub>	5	mA
Pins ⑫ and ⑬ Flow Current	I <sub>12</sub> , I <sub>13</sub>	500	μA

(Note) · Derated above Ta=25°C in the proportion of 4.4mW/°C.

· Handle with care because pin ⑧ of the IC has low electrostatic withstanding voltage.

Fig. 1

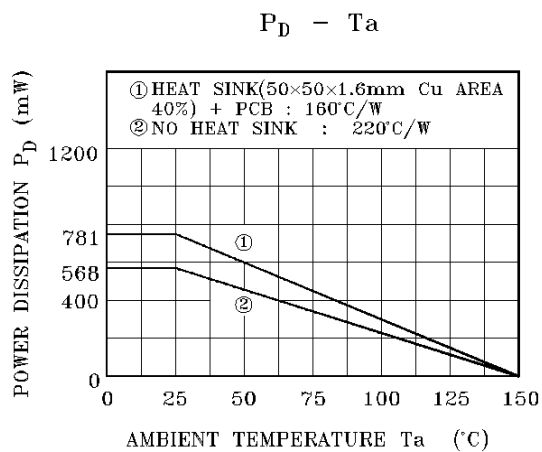

# KIA2039FN

## TARGET ELECTRICAL CHARACTERISTICS

(Unless otherwise specified, the following apply :  $V_{CC}=8.5V$ ,  $T_a=25^\circ C$ )

CHARACTERISTIC	SYMBOL	TEST CONDITION	MIN.	TYP.	MAX.	UNIT	
Power Supply Current With No Signal	$I_{CCQ}$	$V_i=0$ , not including pin diode current	8.2	11.2	17.2	mA	
Diversity Output	$V_9, V_{10}$	-	6.6	6.9	7.2	V	
Diversity Sensitivity	$V_S$	IC only tested ( $f=114kHz$ )	15	25	40	mV <sub>P-0</sub>	
Allowable Input Voltage	$V_{IM}$	$V_2=2V$	DC input only. Monitors Voltage at Pin ⑦.	1.7	2.0	2.3	V
		$V_2=4V$		3.7	4.0	4.3	
		$V_2=6V$		5.7	6.0	6.3	
Weak Electric Field Judge Sensitivity	$V_{S(weak)}$	-	1.7	2.0	2.4	V	
Strong Electric Field Judge Sensitivity	$V_{S(strong)}$	-	1.7	2.0	2.4	V	
Over-Deviation Protector	$V_{th(ODP)}$	$f=10kHz$	280	430	580	mV <sub>rms</sub>	

## TEST CIRCUIT

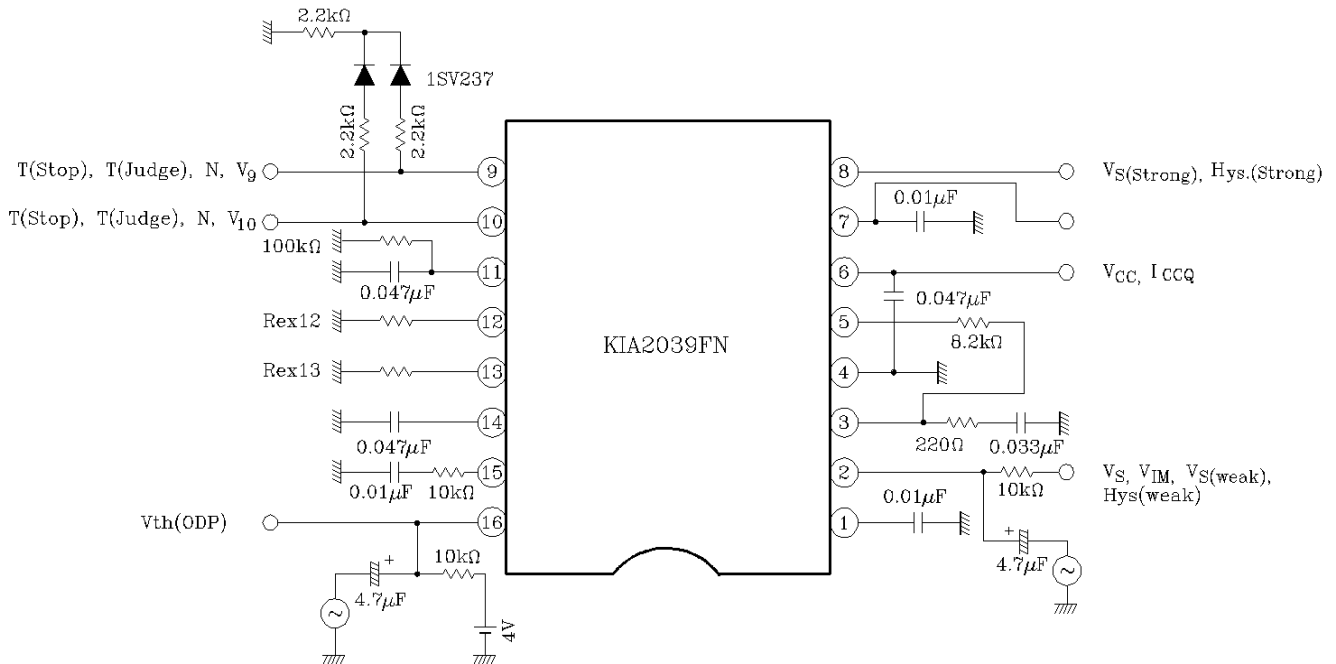

(\*) Test with Rex12 and Rex13 of 10kΩ or more.

# KIA2039FN

## BLOCK DIAGRAM

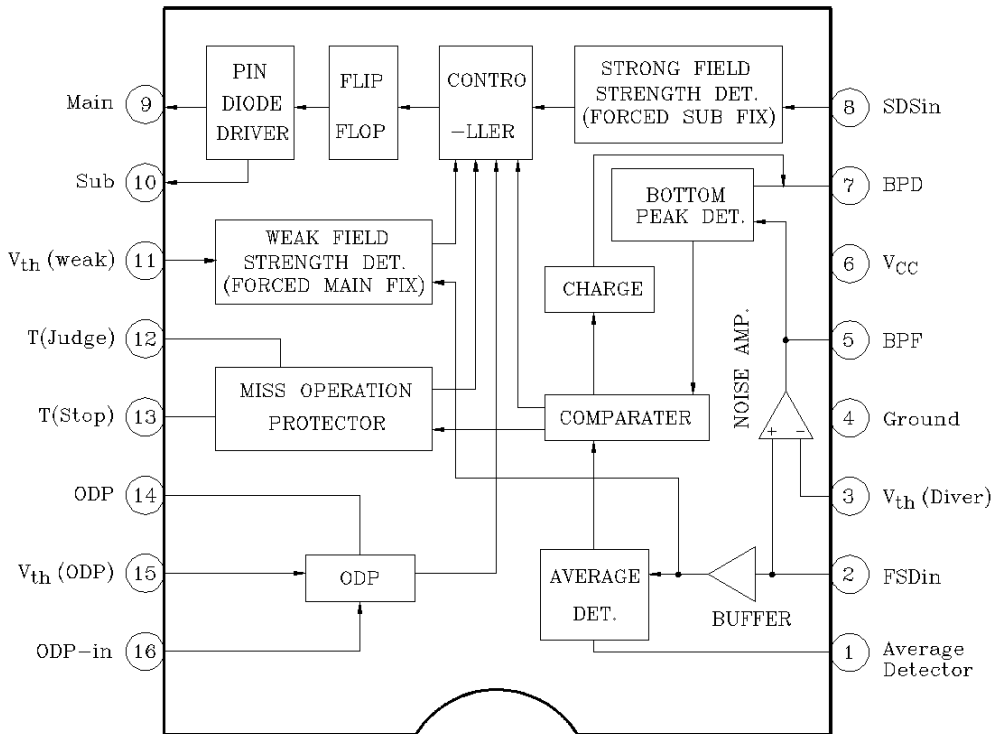

## PINS

Pin No.	PIN SYMBOL	PIN NAME
1	Average Detector	Average value detector
2	FSDin	Electric field detect signal input
3	$V_{th}(Diver)$	Diversity optional sensitivity trimmer
4	Ground	Ground
5	BPF	Band pass filter
6	$V_{CC}$	Power supply
7	BPD	Bottom peak detector
8	SFSin	Strong electric field judge input
9	Main	Main output
10	Sub	Sub output
11	$V_{th}(weak)$	Weak electric judge trimmer
12	T(judge)	Miss operation judge time trimmer
13	T(Stop)	Miss operation stop time trimmer
14	ODP	Over-deviation protector
15	$V_{th}(ODP)$	Over-deviation protector sensitivity timmer
16	ODP-in	Over-deviation protector input

# KIA2039FN

## APPLICATION CIRCUIT (Diversity IC block)

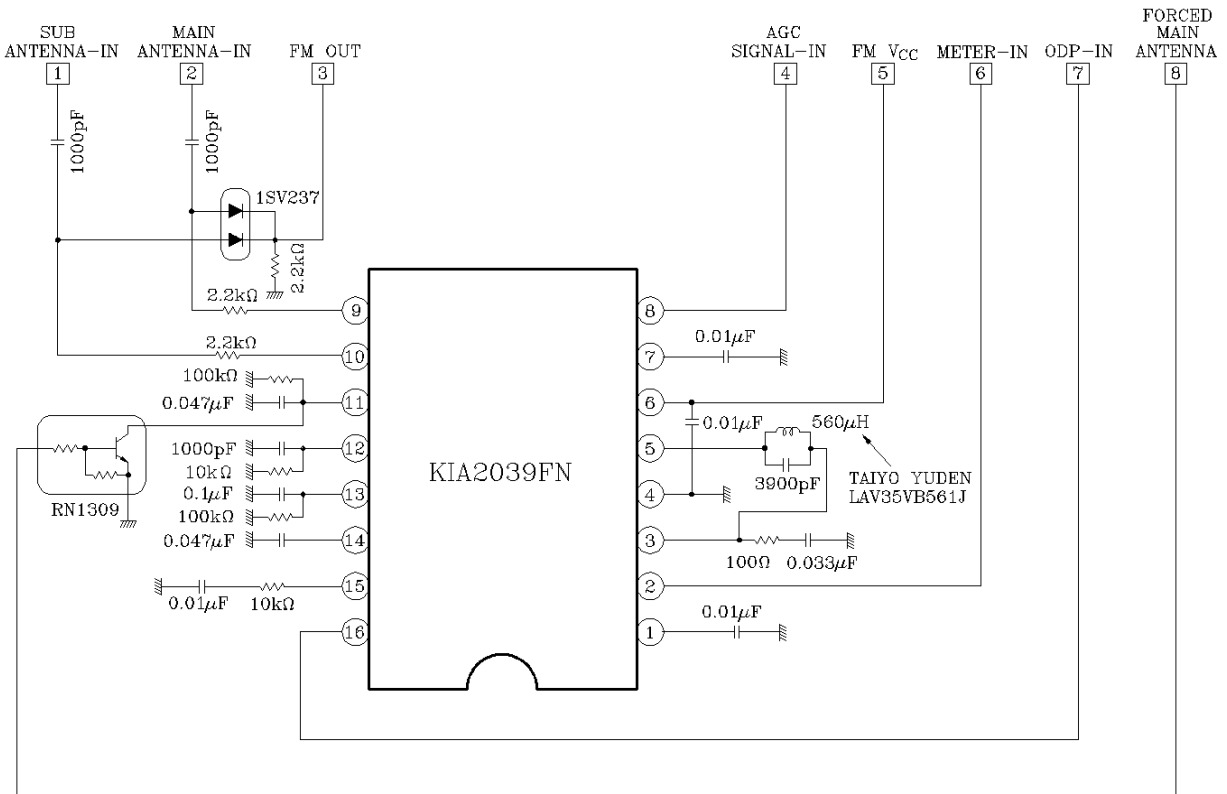

(\*) The external constants of pin⑫, T(judge), and pin⑬, T(STOP), may need to be changed depending on the running test or simulation conditions.

# KIA2039FN

## PIN FUNCTION

(Pin voltage is a typical value when  $V_{CC}=8.5V$ ,  $T_a=25^{\circ}C$ , and no DC signal is input to the test circuit.)

PIN NO.	PIN NAME	PIN VOLTAGE (V)	INTERNAL EQUIPMENT CIRCUIT/EXTERNAL TYPICAL VALUE (INTERNAL R AND C VALUES ARE TYPICAL)	PIN FUNCTION
1	Average Detector	0.75		Average value detector pin. Connect a capacitor externally.
7	Peak Detector	0		Bottom peak detector pin. Connect a capacitor externally.
2	FSDin	0		Electric field detector input pin. Connect this pin directly to electric field detector output pin of, for example, FM processor KIA2027F at the next step. Note that the internal ground resistance of the electric field detector output pin of the FM processor must be $27k\Omega$ or less.
3	$V_{th}$ (Driver)	0		Feedback pin for the noise amp. For gain setting, connect a resistor and a capacitor externally. When resistance is small, gain is large. In the example, antennas are switched when the modulation factor is 5% or more of the 114kHz signal component.
5	BPF	0		Output pin for the noise amp. Connect LC parallel resonant circuit externally between pin 3 and NF. In the application circuit example, noise due to diversity IC operation is detected outside the composite signal band, 114kHz $f_0$ is set. Be careful with $Z$ vs $f$ of the inductor. (In the example, $Z=8.2k\Omega$ at $f=114kHz$ )

# KIA2039FN

PIN NO.	PIN NAME	PIN VOLTAGE (V)	INTERNAL EQUIPMENT CIRCUIT/EXTERNAL TYPICAL VALUE (INTERNAL R AND C VALUES ARE TYPICAL)	PIN FUNCTION
4	GND	0		Power supply pin and ground pin. Connect a capacitor between these pins.
6	V <sub>CC</sub>	8.5		Diversity output pins for the main and sub antennas. For example, connect a PIN diode externally for switching antennas.
9	Main	7		
10	Sub	0		
8	Strong Field Strength-in	-		Strong electric field detect pin. Connect the PIN diode of KIA2054AF FM front end externally for antenna damping output.
11	V <sub>th</sub> (weak)	0		Weak electric field judge setting pin. Current in proportion to the strength of the electric field is output internally. The internal V <sub>th</sub> is set so that when the potential of the external resistor is 2V or less, weak electric field is determined, and the main antenna is fixed. To force fix the main antenna, ground the external digital transistor (eg, TOSHIBA RN1309). Note that an external capacitor is used to set the time constant for judging weak electric field. In the example, combining RF processor KIA2054AF with FM processor KIA2027F results in approximately 15dB $\mu$ V to judge weak electric field.

# KIA2039FN

PIN NO.	PIN NAME	PIN VOLTAGE (V)	INTERNAL EQUIPMENT CIRCUIT/EXTERNAL TYPICAL VALUE (INTERNAL R AND C VALUES ARE TYPICAL)	PIN FUNCTION
12	T(judge)	-		Used to count time for switching misoperation. An external capacitor is used for counting. When capacitance is large, the count time is long. The maximum number of misoperations is 4 antenna changes.
13	T(Stop)	-		When the number of misoperations reaches four within the time set by pin⑫, T(judge), stops antenna switching. The time set by this pin is used to fix the main antenna. An external capacitor is used to set the time. When capacitance is large, the time is long.
14	Over Deviation Protector	5		Over-deviation detect pin. Detects the peak of the signal input to pin⑭. Connect a capacitor externally.
15	V <sub>th</sub> (ODP)	0		Used to set over-deviation misoperation detect sensitivity. When the signal detected at pin⑭ is over-deviated, fixes the main antenna to prevent antenna switching misoperation. An external resistor and capacitor are used to set over-deviation detect sensitivity and obtain frequency characteristics.
16	ODP <sub>in</sub>	0		Input pin for the over-deviation misoperation protector. Directly connect to this pin the detect output pin of the FM processor KIA2027F at the next step.



# KIA2039FN

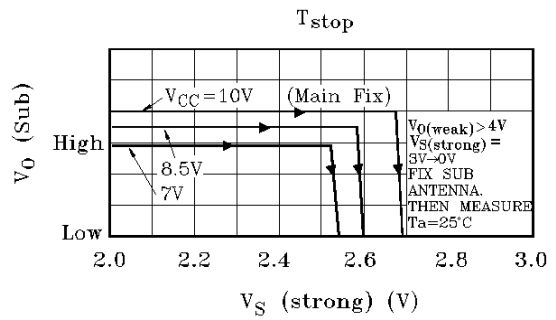
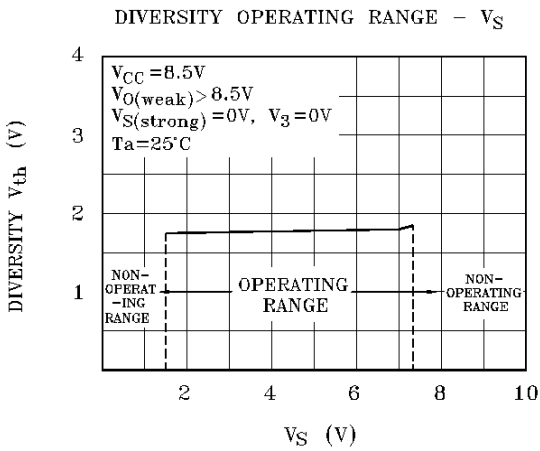
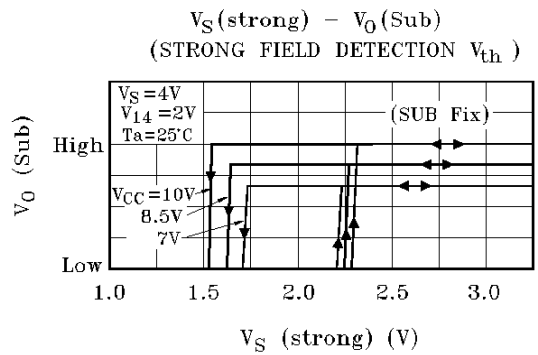
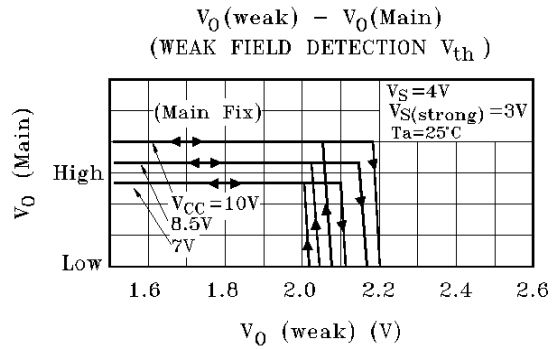
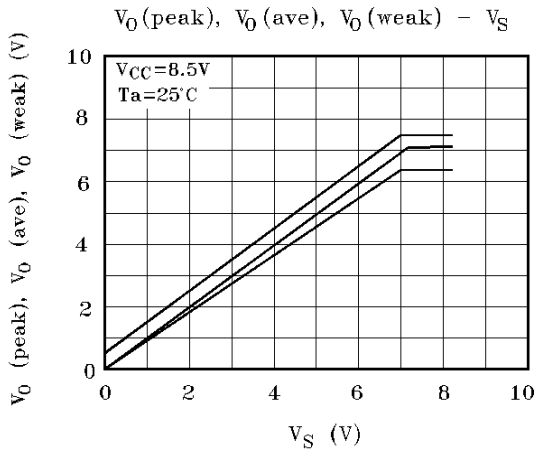
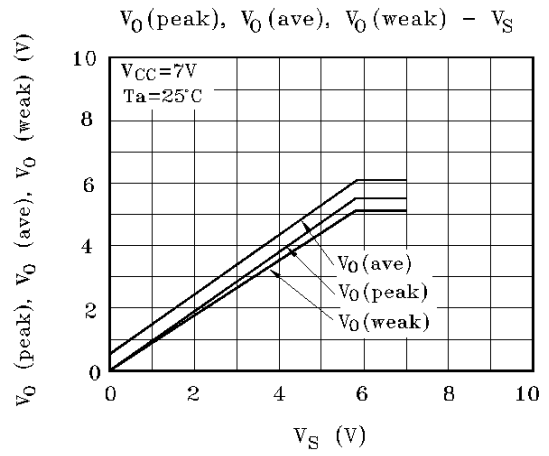
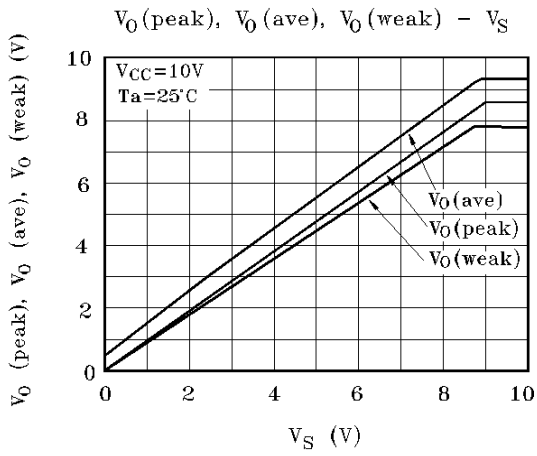

# KIA2039FN

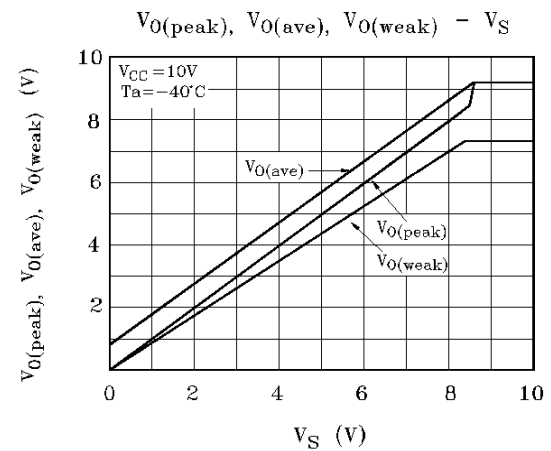
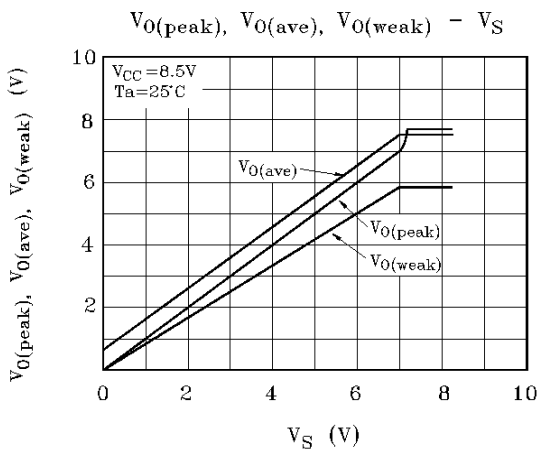
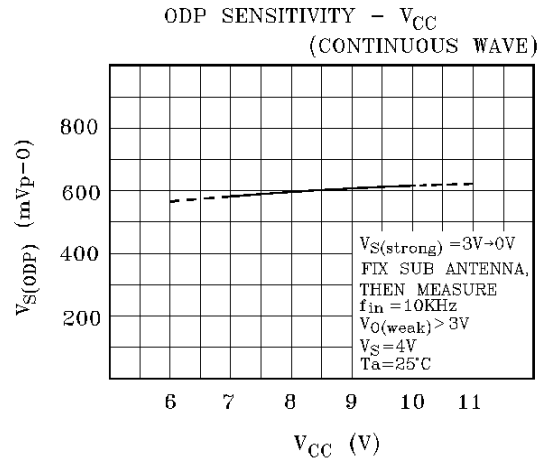
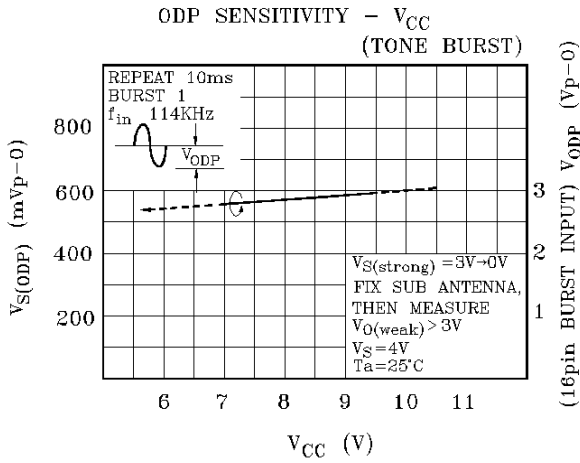
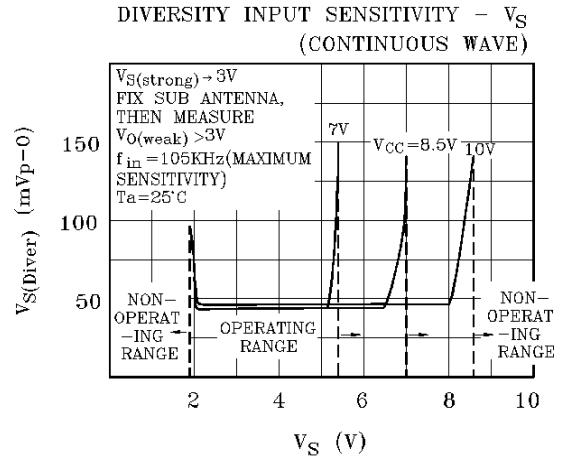
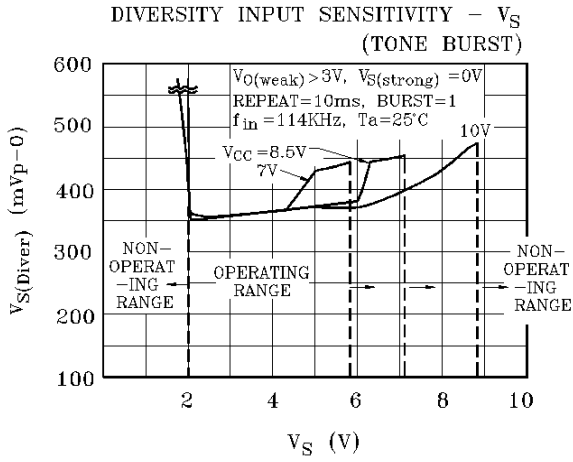

# KIA2039FN

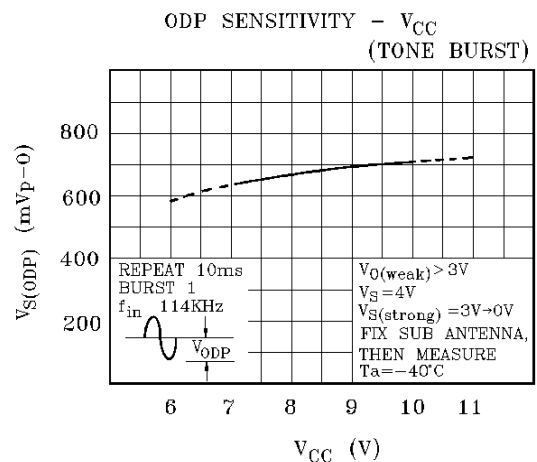
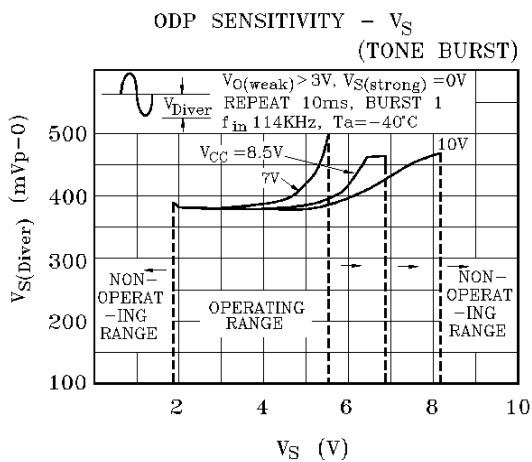
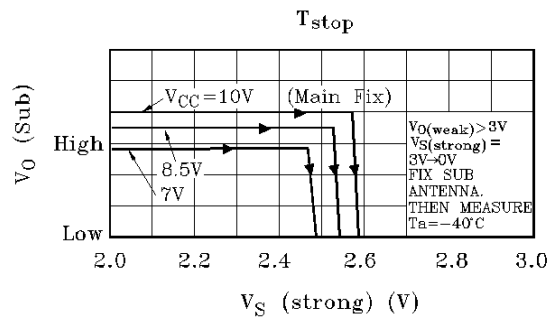
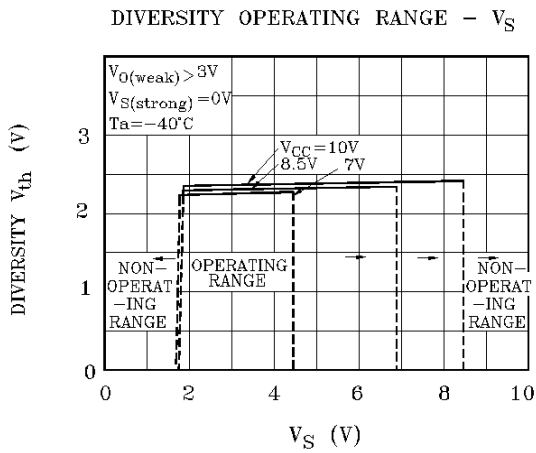
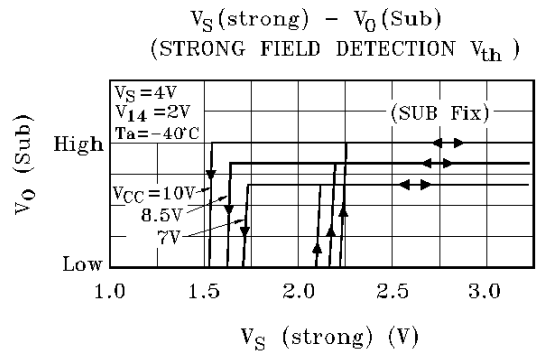
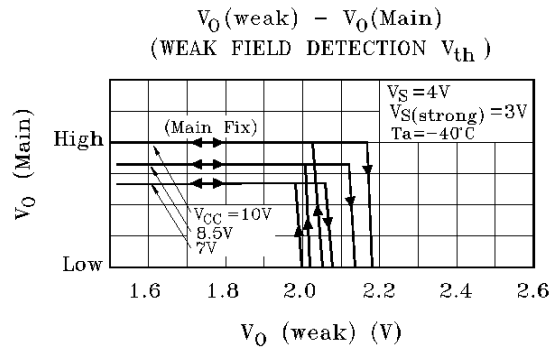
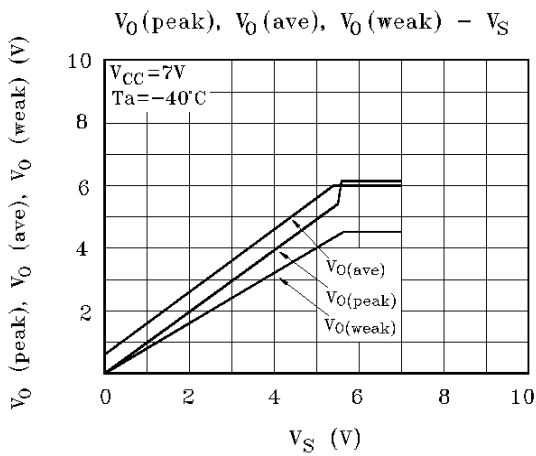

# KIA2039FN

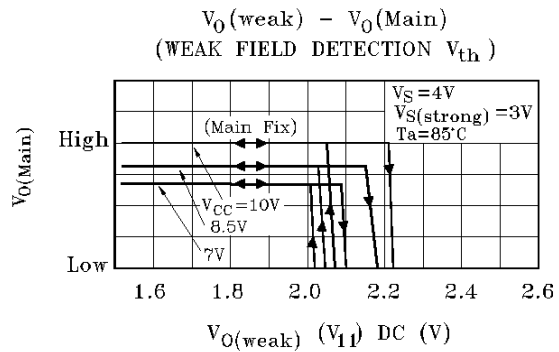
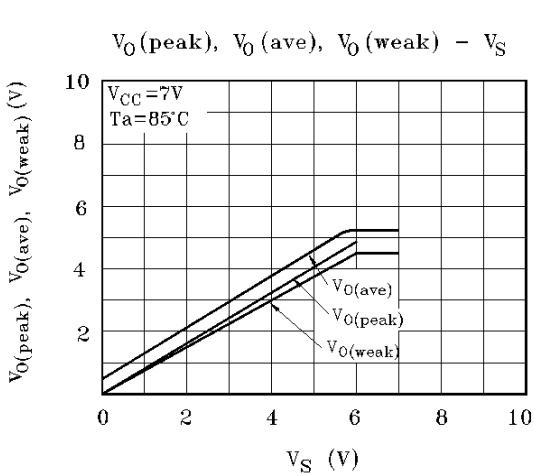
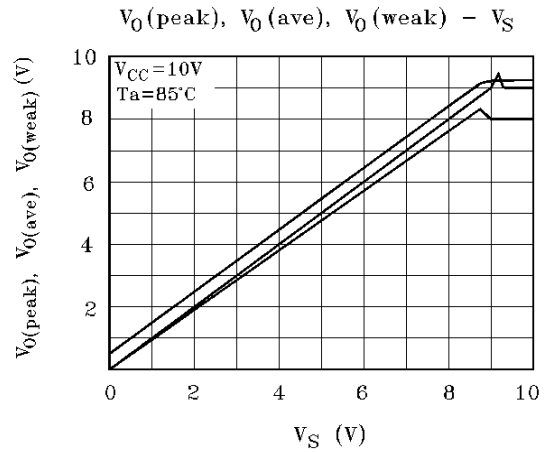
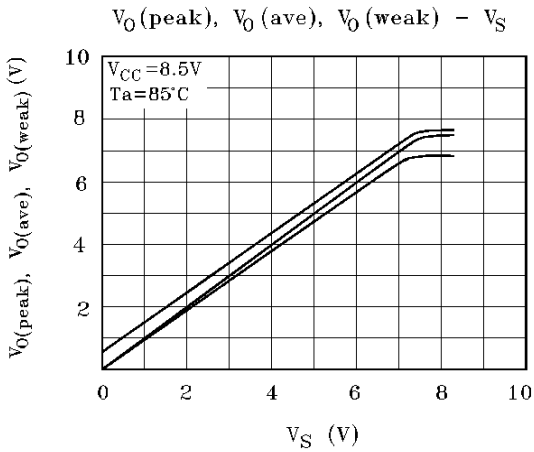
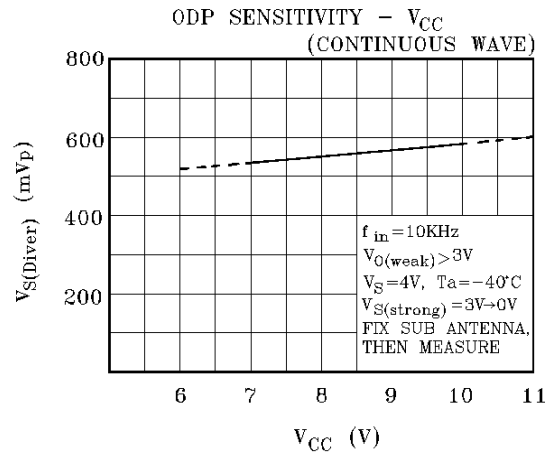
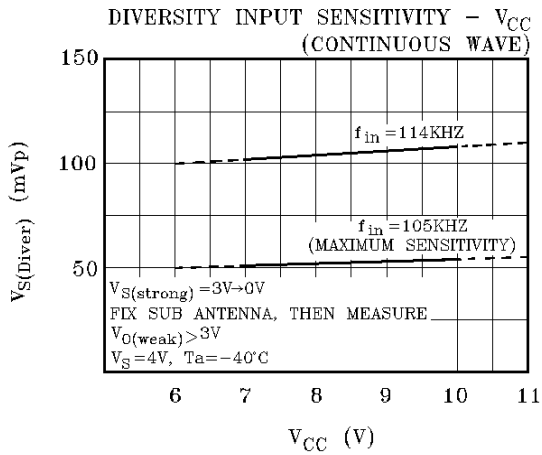

# KIA2039FN

$V_S(\text{strong}) - V_O(\text{Sub})$   
(STRONG FIELD DETECTION  $V_{th}$ )

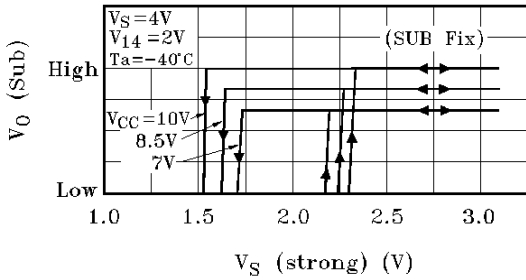

DIVERSITY OPERATING RANGE -  $V_S$

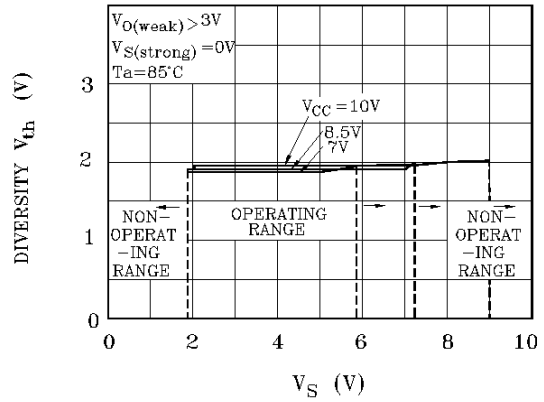

$T_{stop}$

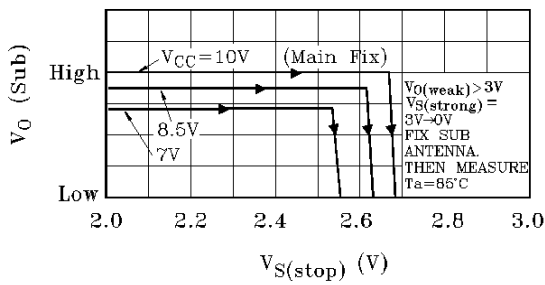

DIVERSITY INPUT SENSITIVITY -  $V_S$   
(TONE BURST)

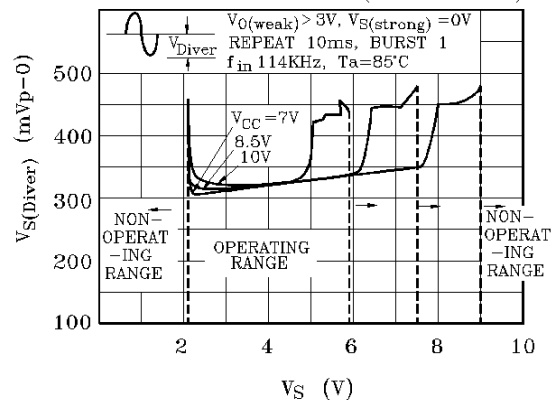

ODP SENSITIVITY -  $V_{CC}$   
(TONE BURST)

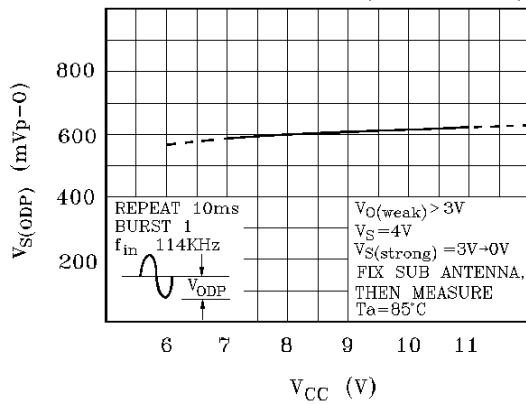

DIVERSITY INPUT SENSITIVITY -  $V_{CC}$   
(CONTINUOUS WAVE)

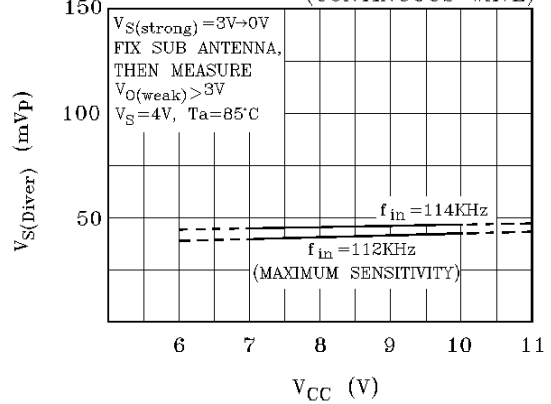

# KIA2039FN

