

## INSULATED GATE BIPOLAR TRANSISTOR WITH ULTRAFAST SOFT RECOVERY DIODE

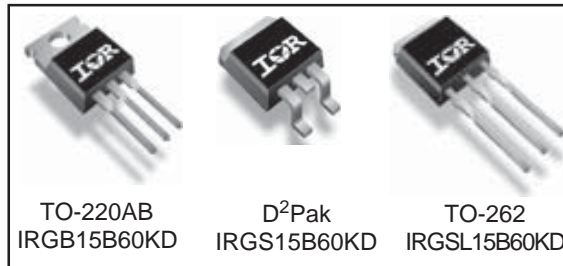
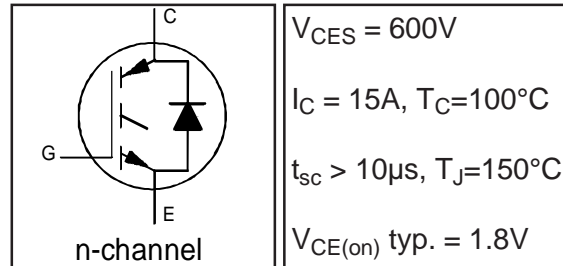
IRGB15B60KD  
IRGS15B60KD  
IRGSL15B60KD

### Features

- Low VCE (on) Non Punch Through IGBT Technology.
- Low Diode VF.
- 10µs Short Circuit Capability.
- Square RBSOA.
- Ultrasoft Diode Reverse Recovery Characteristics.
- Positive VCE (on) Temperature Coefficient.

### Benefits

- Benchmark Efficiency for Motor Control.
- Rugged Transient Performance.
- Low EMI.
- Excellent Current Sharing in Parallel Operation.



### Absolute Maximum Ratings

	Parameter	Max.	Units
$V_{CES}$	Collector-to-Emitter Voltage	600	V
$I_C @ T_C = 25^\circ C$	Continuous Collector Current	31	A
$I_C @ T_C = 100^\circ C$	Continuous Collector Current	15	
$I_{CM}$	Pulsed Collector Current	62	
$I_{LM}$	Clamped Inductive Load Current	62	
$I_F @ T_C = 25^\circ C$	Diode Continuous Forward Current	31	
$I_F @ T_C = 100^\circ C$	Diode Continuous Forward Current	15	
$I_{FM}$	Diode Maximum Forward Current	64	
$V_{GE}$	Gate-to-Emitter Voltage	$\pm 20$	V
$P_D @ T_C = 25^\circ C$	Maximum Power Dissipation	208	W
$P_D @ T_C = 100^\circ C$	Maximum Power Dissipation	83	
$T_J$	Operating Junction and	-55 to +150	°C
$T_{STG}$	Storage Temperature Range		
	Soldering Temperature, for 10 sec.	300 (0.063 in. (1.6mm) from case)	

### Thermal Resistance

	Parameter	Min.	Typ.	Max.	Units
$R_{\theta JC}$	Junction-to-Case - IGBT	—	—	0.6	°C/W
$R_{\theta JC}$	Junction-to-Case - Diode	—	—	2.1	
$R_{\theta CS}$	Case-to-Sink, flat, greased surface	—	0.50	—	
$R_{\theta JA}$	Junction-to-Ambient, typical socket mount①	—	—	62	
$R_{\theta JA}$	Junction-to-Ambient (PCB Mount, steady state)②	—	—	40	
Wt	Weight	—	1.44	—	g

# IRG/B/S/SL15B60KD

International  
**IRF** Rectifier

## Electrical Characteristics @ $T_J = 25^\circ\text{C}$ (unless otherwise specified)

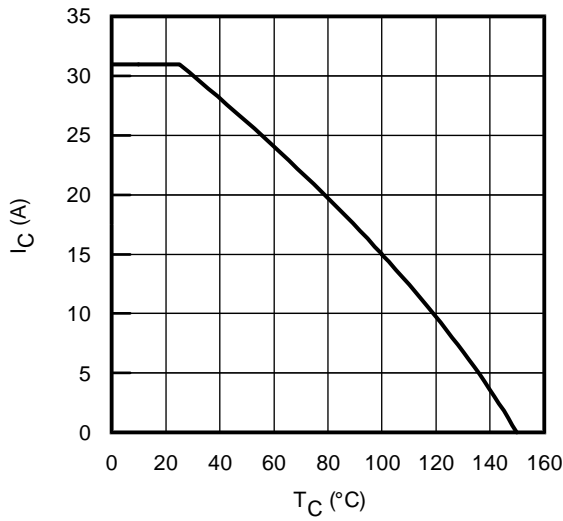
	Parameter	Min.	Typ.	Max.	Units	Conditions	Ref.Fig.
$V_{(BR)CES}$	Collector-to-Emitter Breakdown Voltage	600	—	—	V	$V_{GE} = 0V, I_C = 500\mu A$	
$\Delta V_{(BR)CES}/\Delta T_J$	Temperature Coeff. of Breakdown Voltage	—	0.3	—	V/ $^\circ\text{C}$	$V_{GE} = 0V, I_C = 1.0mA, (25^\circ\text{C}-150^\circ\text{C})$	
$V_{CE(on)}$	Collector-to-Emitter Saturation Voltage	1.5	1.80	2.20	V	$I_C = 15A, V_{GE} = 15V$	5, 6,7
		—	2.05	2.50		$I_C = 15A, V_{GE} = 15V, T_J = 125^\circ\text{C}$	9, 10,11
		—	2.10	2.60		$I_C = 15A, V_{GE} = 15V, T_J = 150^\circ\text{C}$	
$V_{GE(th)}$	Gate Threshold Voltage	3.5	4.5	5.5	V	$V_{CE} = V_{GE}, I_C = 250\mu A$	9, 10,11
$\Delta V_{GE(th)}/\Delta T_J$	Temperature Coeff. of Threshold Voltage	—	-10	—	mV/ $^\circ\text{C}$	$V_{CE} = V_{GE}, I_C = 1.0mA, (25^\circ\text{C}-150^\circ\text{C})$	12
$g_{fe}$	Forward Transconductance	—	10.6	—	S	$V_{CE} = 50V, I_C = 20A, PW=80\mu s$	
$I_{CES}$	Zero Gate Voltage Collector Current	—	5.0	150	$\mu A$	$V_{GE} = 0V, V_{CE} = 600V$	
		—	500	1000		$V_{GE} = 0V, V_{CE} = 600V, T_J = 150^\circ\text{C}$	
$V_{FM}$	Diode Forward Voltage Drop	—	1.20	1.45	V	$I_C = 15A$	8
		—	1.20	1.45		$I_C = 15A, T_J = 150^\circ\text{C}$	
$I_{GES}$	Gate-to-Emitter Leakage Current	—	—	$\pm 100$	nA	$V_{GE} = \pm 20V$	

## Switching Characteristics @ $T_J = 25^\circ\text{C}$ (unless otherwise specified)

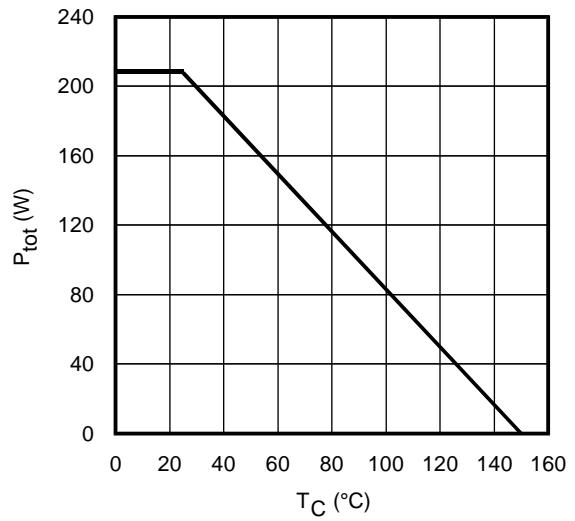
	Parameter	Min.	Typ.	Max.	Units	Conditions	Ref.Fig.
$Q_g$	Total Gate Charge (turn-on)	—	56	84	nC	$I_C = 15A$	CT1
$Q_{ge}$	Gate - Emitter Charge (turn-on)	—	7.0	10		$V_{CC} = 400V$	
$Q_{gc}$	Gate - Collector Charge (turn-on)	—	26	39		$V_{GE} = 15V$	
$E_{on}$	Turn-On Switching Loss	—	220	330	$\mu J$	$I_C = 15A, V_{CC} = 400V$	CT4
$E_{off}$	Turn-Off Switching Loss	—	340	455		$V_{GE} = 15V, R_G = 22\Omega, L = 200\mu H$	
$E_{tot}$	Total Switching Loss	—	560	785		$L_s = 150nH, T_J = 25^\circ\text{C}$ ③	
$t_{d(on)}$	Turn-On Delay Time	—	34	44	ns	$I_C = 15A, V_{CC} = 400V$	CT4
$t_r$	Rise Time	—	16	22		$V_{GE} = 15V, R_G = 22\Omega, L = 200\mu H$	
$t_{d(off)}$	Turn-Off Delay Time	—	184	200		$L_s = 150nH, T_J = 25^\circ\text{C}$	
$t_f$	Fall Time	—	20	26			
$E_{on}$	Turn-On Switching Loss	—	355	470	$\mu J$	$I_C = 15A, V_{CC} = 400V$	CT4
$E_{off}$	Turn-Off Switching Loss	—	490	600		$V_{GE} = 15V, R_G = 22\Omega, L = 200\mu H$	
$E_{tot}$	Total Switching Loss	—	835	1070		$L_s = 150nH, T_J = 150^\circ\text{C}$ ③	
$t_{d(on)}$	Turn-On Delay Time	—	34	44	ns	$I_C = 15A, V_{CC} = 400V$	14, 16
$t_r$	Rise Time	—	18	25		$V_{GE} = 15V, R_G = 22\Omega, L = 200\mu H$	
$t_{d(off)}$	Turn-Off Delay Time	—	203	226		$L_s = 150nH, T_J = 150^\circ\text{C}$	
$t_f$	Fall Time	—	28	36			
$C_{ies}$	Input Capacitance	—	850	—	pF	$V_{GE} = 0V$	
$C_{oes}$	Output Capacitance	—	75	—		$V_{CC} = 30V$	
$C_{res}$	Reverse Transfer Capacitance	—	35	—		$f = 1.0MHz$	
RBSOA	Reverse Bias Safe Operating Area	FULL SQUARE				$T_J = 150^\circ\text{C}, I_C = 62A, V_p = 600V$ $V_{CC} = 500V, V_{GE} = +15V \text{ to } 0V, R_G = 22\Omega$	4 CT2
SCSOA	Short Circuit Safe Operating Area	10	—	—	$\mu s$	$T_J = 150^\circ\text{C}, V_p = 600V, R_G = 22\Omega$ $V_{CC} = 360V, V_{GE} = +15V \text{ to } 0V$	CT3 WF4
$E_{rec}$	Reverse Recovery energy of the diode	—	540	720	$\mu J$	$T_J = 150^\circ\text{C}$	17, 18, 19
$t_{rr}$	Diode Reverse Recovery time	—	92	111	ns	$V_{CC} = 400V, I_F = 15A, L = 200\mu H$	20, 21
$I_{rr}$	Diode Peak Reverse Recovery Current	—	29	33	A	$V_{GE} = 15V, R_G = 22\Omega, L_s = 150nH$	CT4, WF3

Note ① to ③ are on page 15

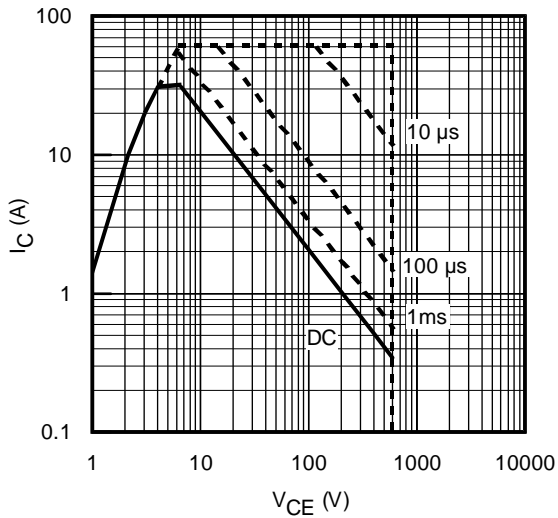
8



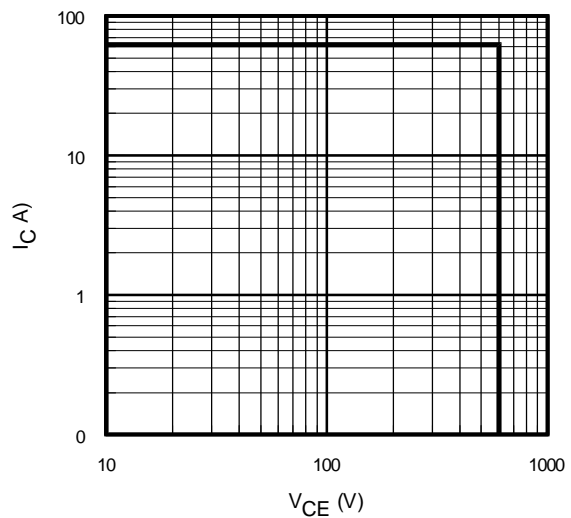
**Fig. 1** - Maximum DC Collector Current vs. Case Temperature



**Fig. 2** - Power Dissipation vs. Case Temperature

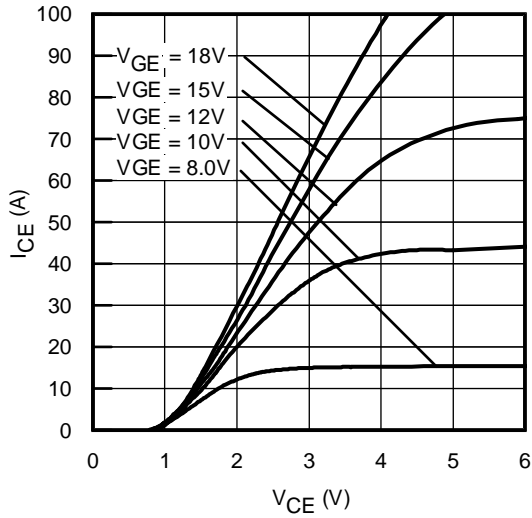


**Fig. 3** - Forward SOA  
 $T_C = 25^\circ\text{C}; T_J \leq 150^\circ\text{C}$

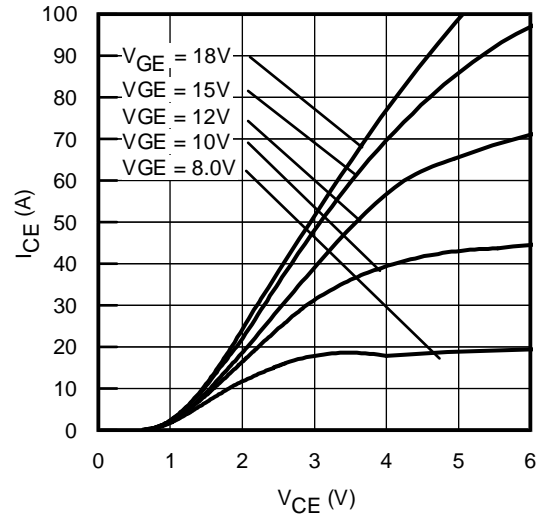


**Fig. 4** - Reverse Bias SOA  
 $T_J = 150^\circ\text{C}; V_{GE} = 15\text{V}$

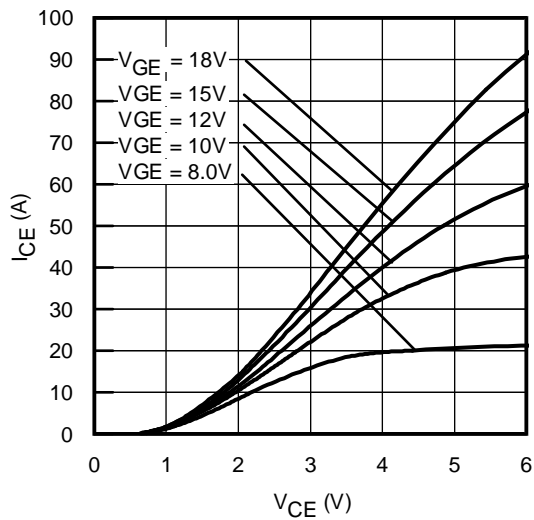
# IRG/B/S/SL15B60KD



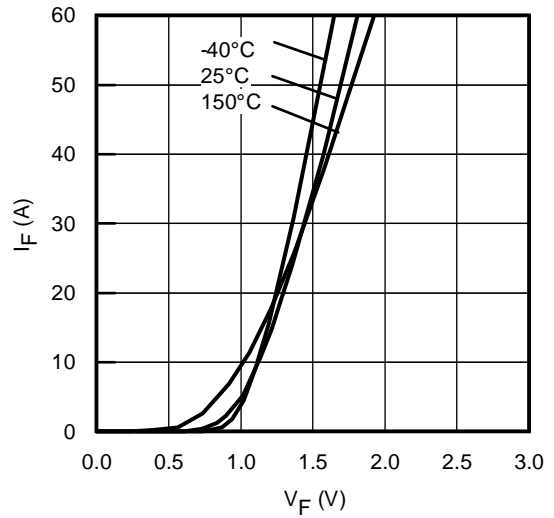
**Fig. 5** - Typ. IGBT Output Characteristics  
 $T_J = -40^\circ\text{C}$ ;  $t_p = 300\mu\text{s}$



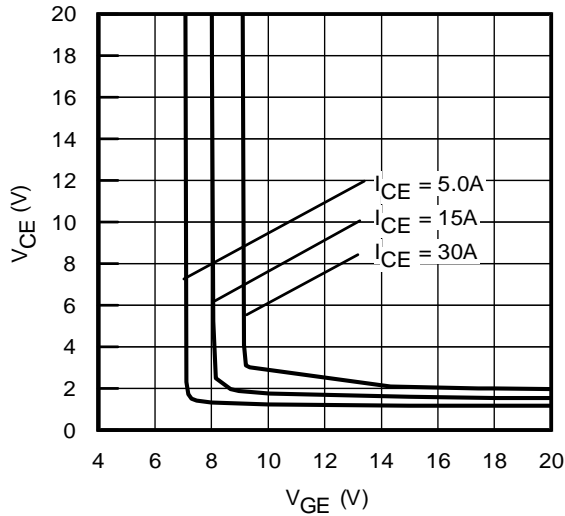
**Fig. 6** - Typ. IGBT Output Characteristics  
 $T_J = 25^\circ\text{C}$ ;  $t_p = 300\mu\text{s}$



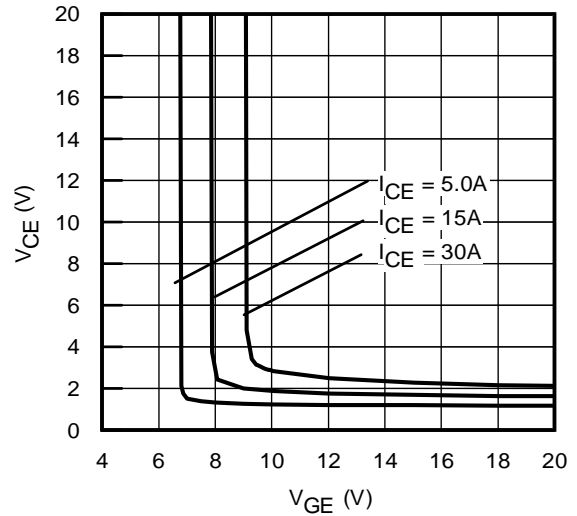
**Fig. 7** - Typ. IGBT Output Characteristics  
 $T_J = 150^\circ\text{C}$ ;  $t_p = 300\mu\text{s}$



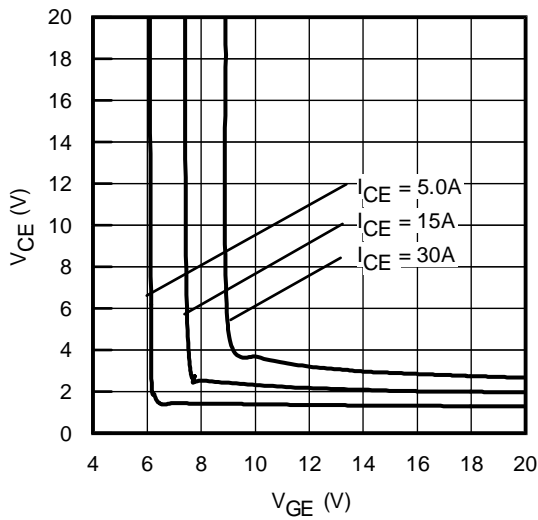
**Fig. 8** - Typ. Diode Forward Characteristics  
 $t_p = 80\mu\text{s}$



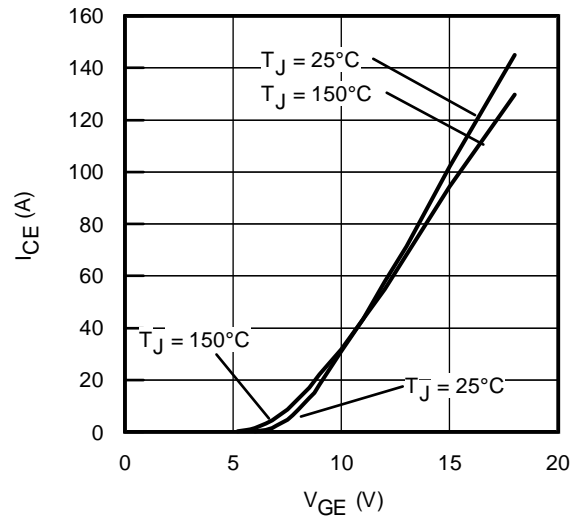
**Fig. 9** - Typical V<sub>CE</sub> vs. V<sub>GE</sub>  
T<sub>J</sub> = -40°C



**Fig. 10** - Typical V<sub>CE</sub> vs. V<sub>GE</sub>  
T<sub>J</sub> = 25°C

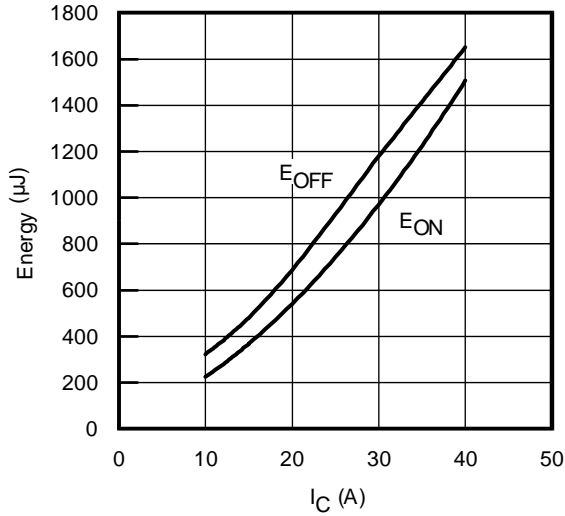


**Fig. 11** - Typical V<sub>CE</sub> vs. V<sub>GE</sub>  
T<sub>J</sub> = 150°C

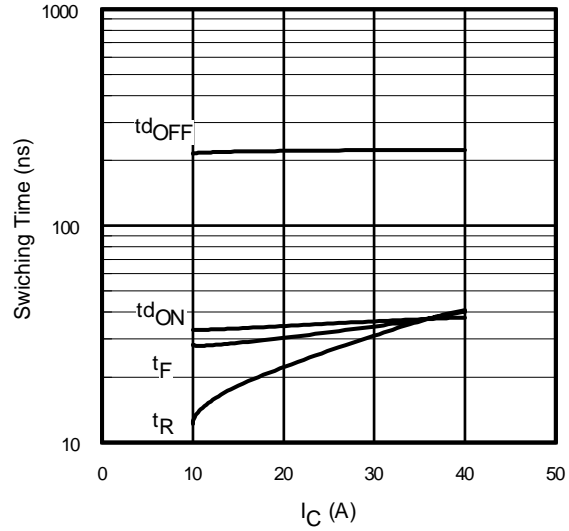


**Fig. 12** - Typ. Transfer Characteristics  
V<sub>CE</sub> = 50V; t<sub>p</sub> = 10μs

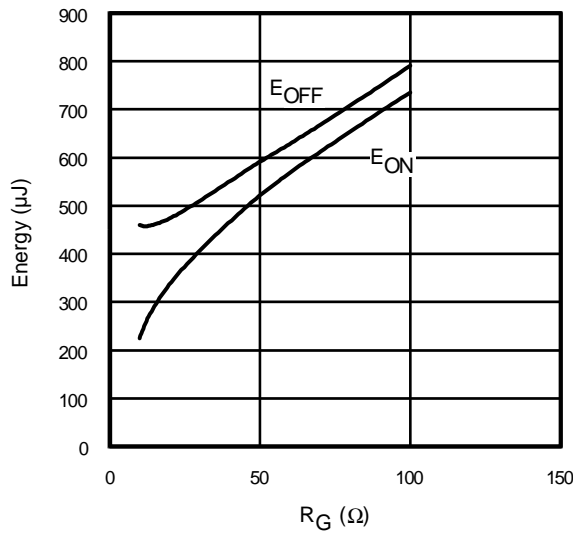
# IRG/B/S/SL15B60KD



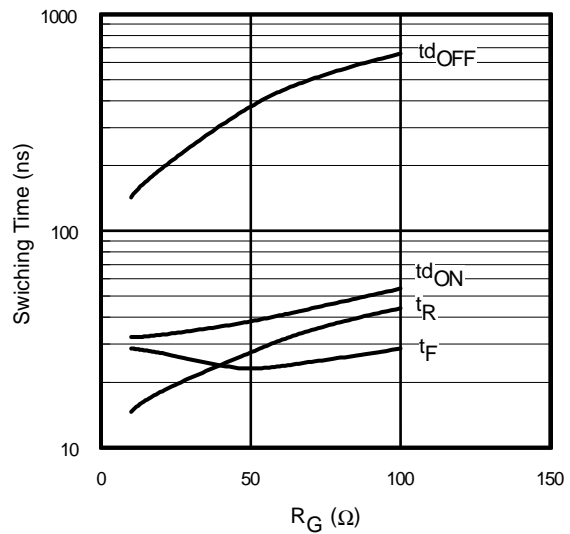
**Fig. 13** - Typ. Energy Loss vs.  $I_C$   
 $T_J = 150^\circ\text{C}$ ;  $L=200\mu\text{H}$ ;  $V_{CE}= 400\text{V}$   
 $R_G= 22\Omega$ ;  $V_{GE}= 15\text{V}$



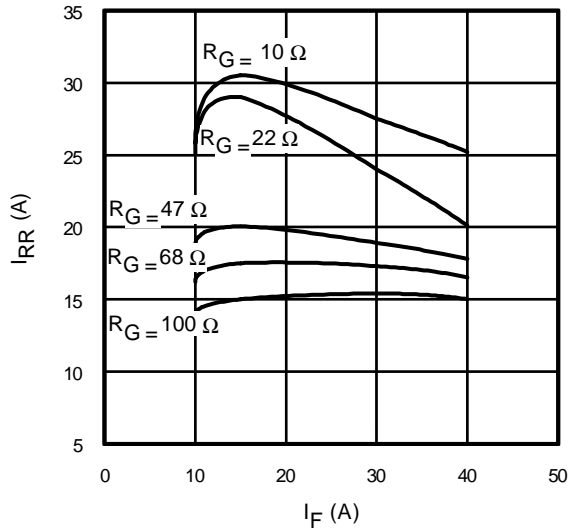
**Fig. 14** - Typ. Switching Time vs.  $I_C$   
 $T_J = 150^\circ\text{C}$ ;  $L=200\mu\text{H}$ ;  $V_{CE}= 400\text{V}$   
 $R_G= 22\Omega$ ;  $V_{GE}= 15\text{V}$



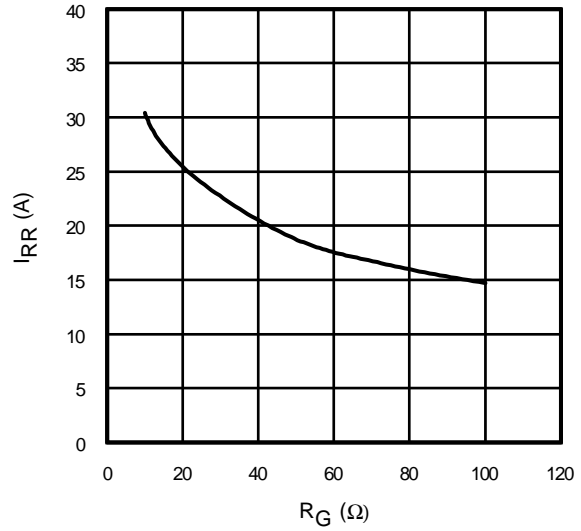
**Fig. 15** - Typ. Energy Loss vs.  $R_G$   
 $T_J = 150^\circ\text{C}$ ;  $L=200\mu\text{H}$ ;  $V_{CE}= 400\text{V}$   
 $I_{CE}= 15\text{A}$ ;  $V_{GE}= 15\text{V}$



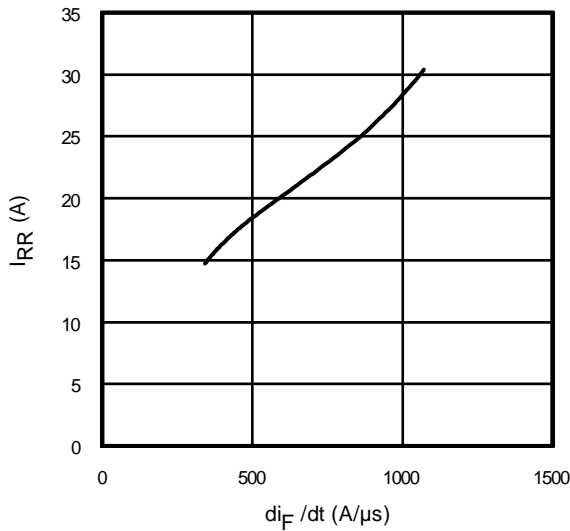
**Fig. 16**- Typ. Switching Time vs.  $R_G$   
 $T_J = 150^\circ\text{C}$ ;  $L=200\mu\text{H}$ ;  $V_{CE}= 600\text{V}$   
 $I_{CE}= 15\text{A}$ ;  $V_{GE}= 15\text{V}$



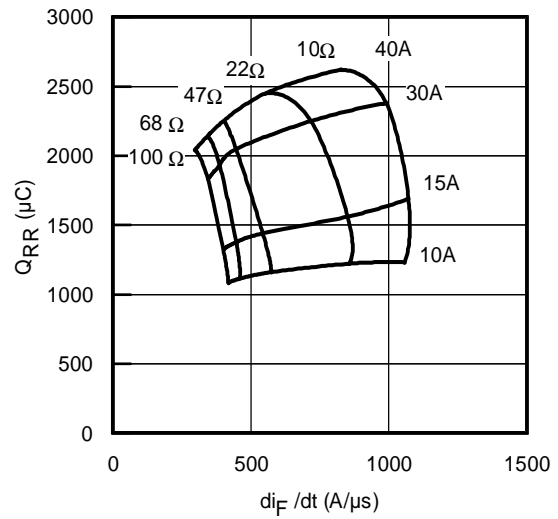
**Fig. 17** - Typical Diode  $I_{RR}$  vs.  $I_F$   
 $T_J = 150^\circ\text{C}$



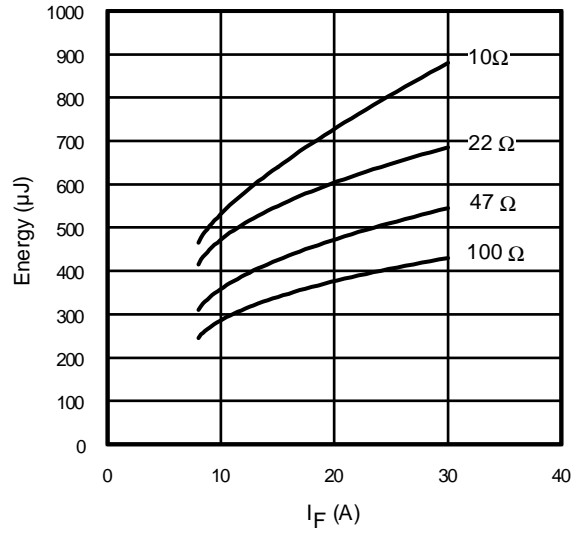
**Fig. 18** - Typical Diode  $I_{RR}$  vs.  $R_G$   
 $T_J = 150^\circ\text{C}; I_F = 15\text{A}$



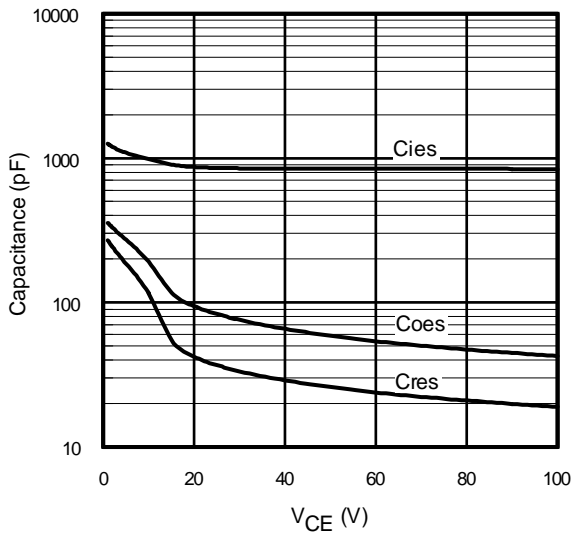
**Fig. 19** - Typical Diode  $I_{RR}$  vs.  $di_F/dt$   
 $V_{CC} = 400\text{V}; V_{GE} = 15\text{V};$   
 $I_{CE} = 15\text{A}; T_J = 150^\circ\text{C}$



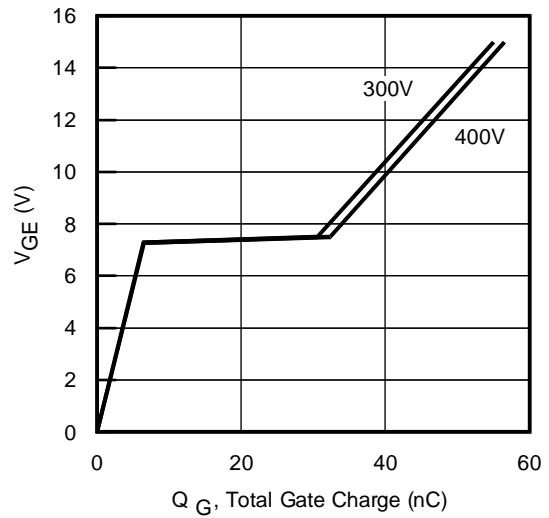
**Fig. 20** - Typical Diode  $Q_{RR}$   
 $V_{CC} = 400\text{V}; V_{GE} = 15\text{V}; T_J = 150^\circ\text{C}$



**Fig. 21** - Typical Diode  $E_{RR}$  vs.  $I_F$   
 $T_J = 150^\circ\text{C}$



**Fig. 22**- Typ. Capacitance vs.  $V_{CE}$   
 $V_{GE} = 0\text{V}$ ;  $f = 1\text{MHz}$



**Fig. 23** - Typical Gate Charge vs.  $V_{GE}$   
 $I_{CE} = 15\text{A}$ ;  $L = 600\ \mu\text{H}$



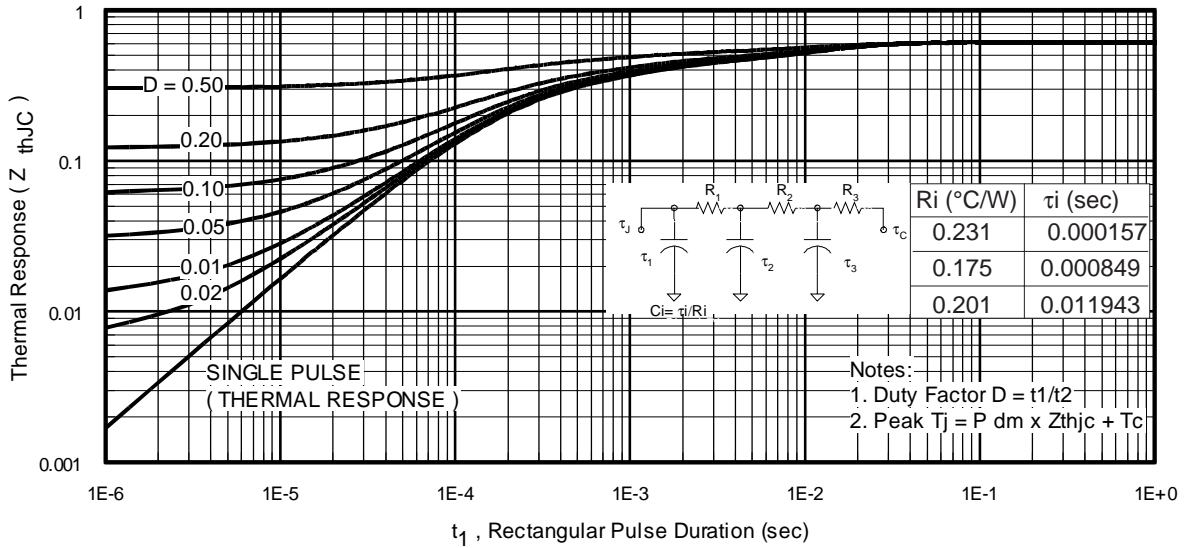


Fig 24. Maximum Transient Thermal Impedance, Junction-to-Case (IGBT)

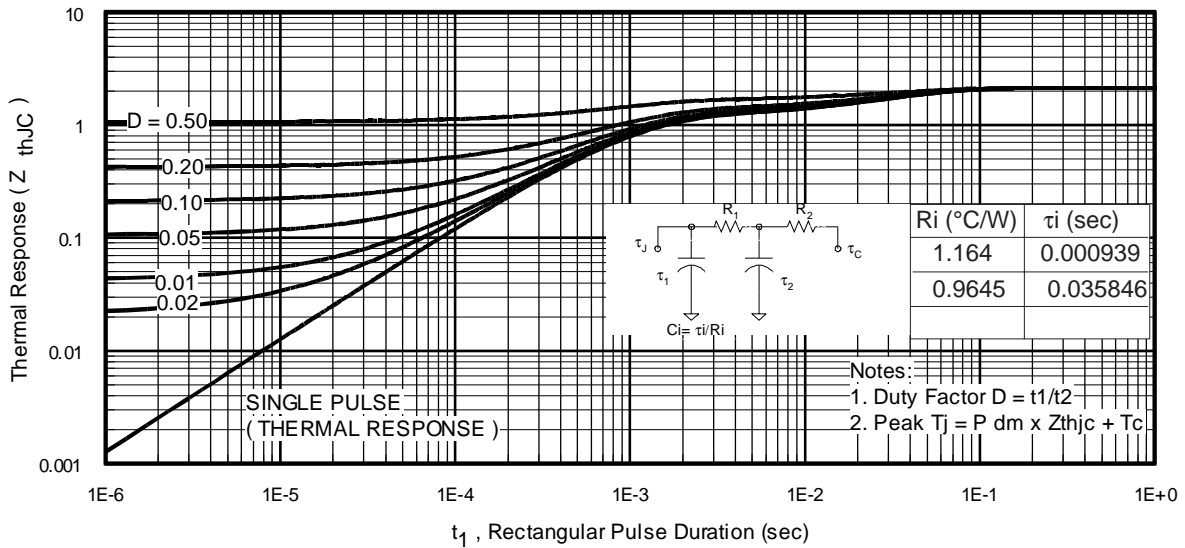
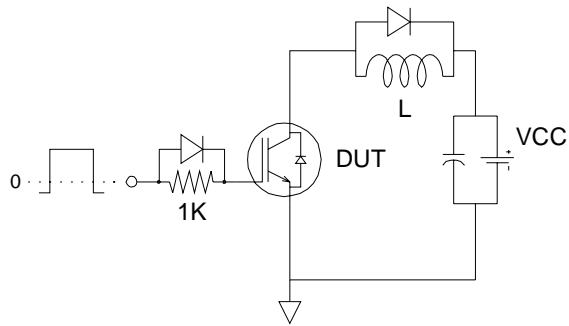
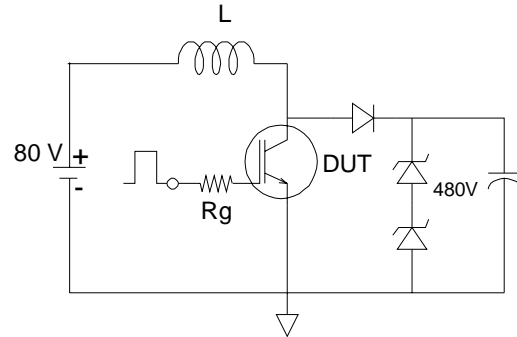


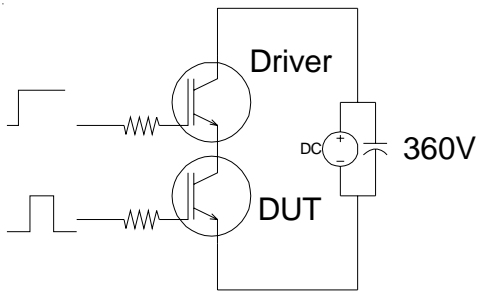
Fig 25. Maximum Transient Thermal Impedance, Junction-to-Case (DIODE)



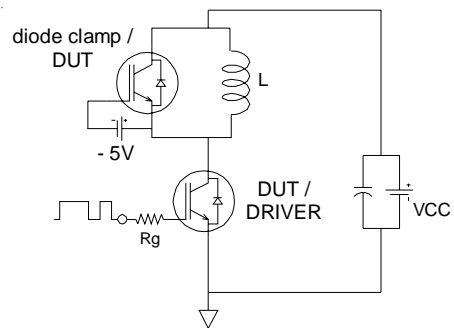
**Fig.C.T.1** - Gate Charge Circuit (turn-off)



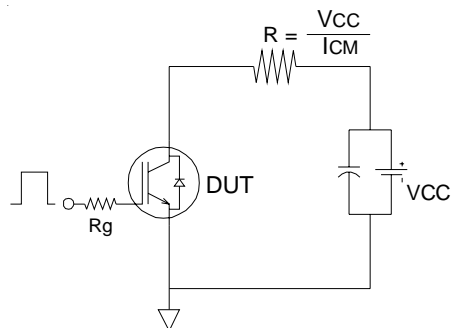
**Fig.C.T.2** - RBSOA Circuit



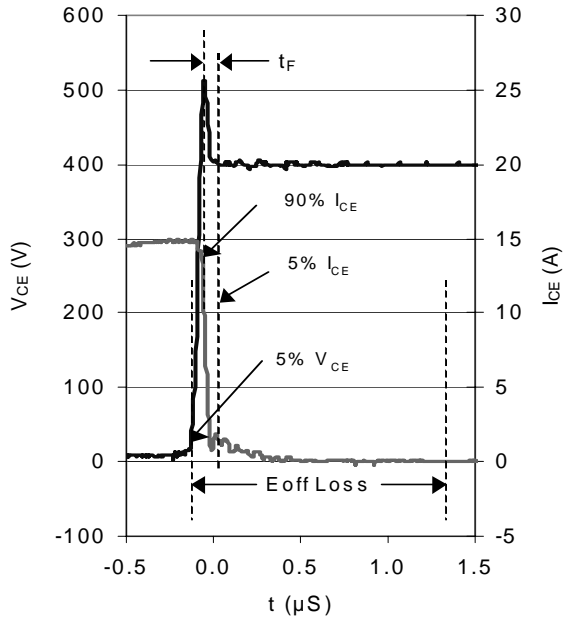
**Fig.C.T.3** - S.C.SOA Circuit



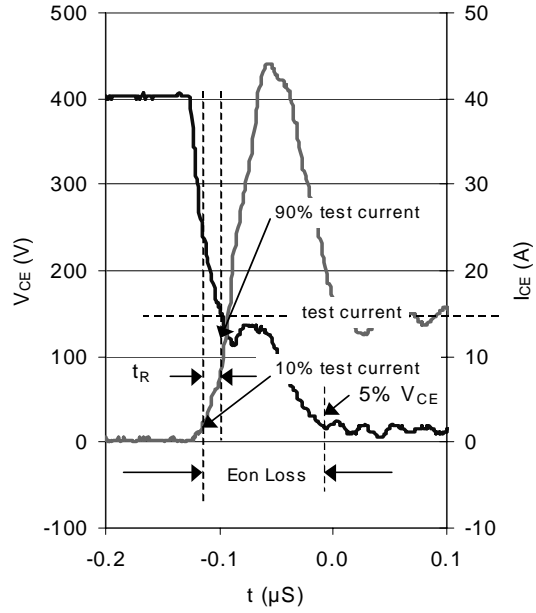
**Fig.C.T.4** - Switching Loss Circuit



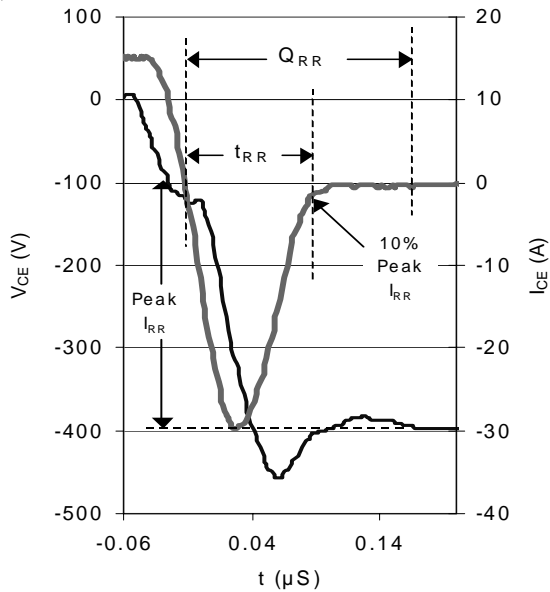
**Fig.C.T.5** - Resistive Load Circuit



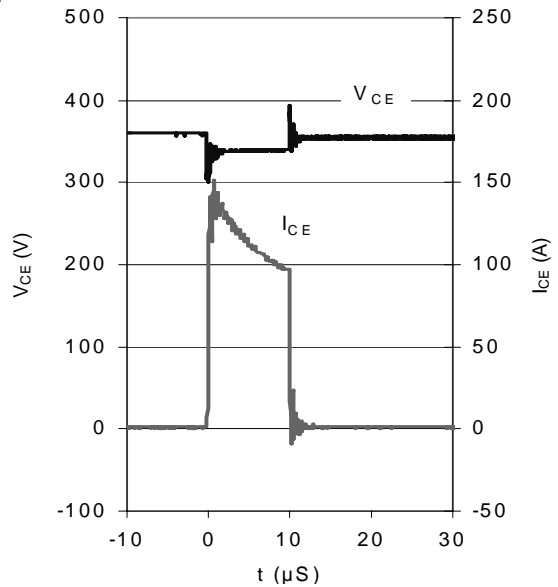
WF.1- Typ. Turn-off Loss  
@  $T_J = 150^\circ\text{C}$  using CT.4



WF.2- Typ. Turn-on Loss  
@  $T_J = 150^\circ\text{C}$  using Fig. CT.4



WF.3- Typ. Reverse Recovery  
@  $T_J = 150^\circ\text{C}$  using CT.4



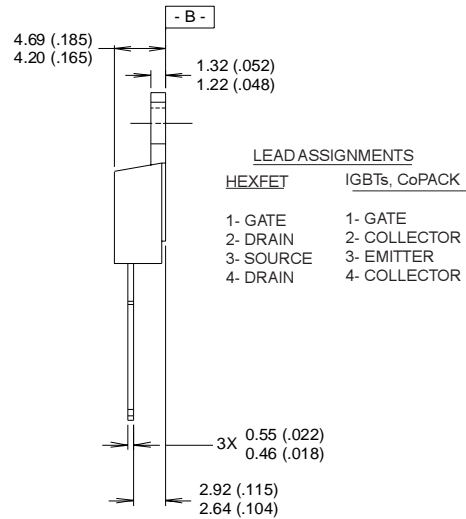
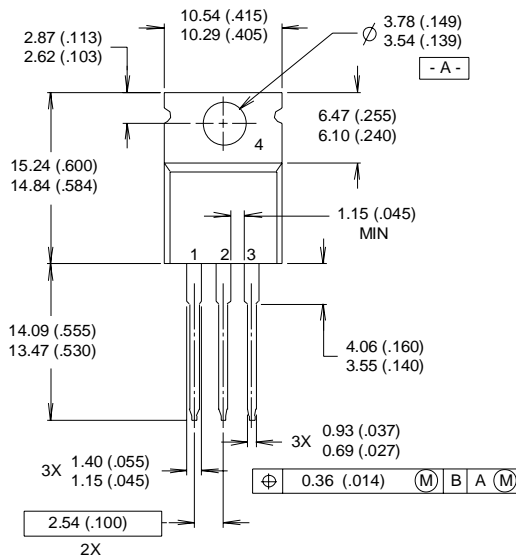
WF.4- Typ. Short Circuit  
@  $T_J = 150^\circ\text{C}$  using CT.3

# IRG/B/S/SL15B60KD



## TO-220AB Package Outline

Dimensions are shown in millimeters (inches)



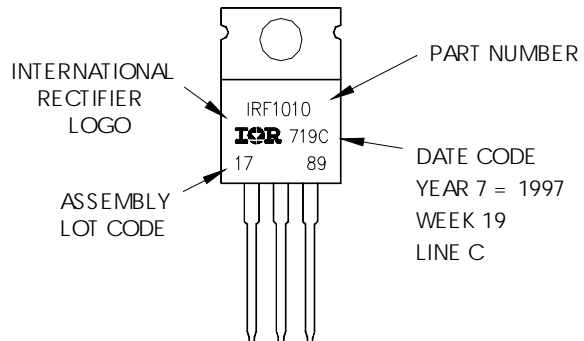
**NOTES:**

- 1 DIMENSIONING & TOLERANCING PER ANSI Y14.5M, 1982.
- 2 CONTROLLING DIMENSION : INCH

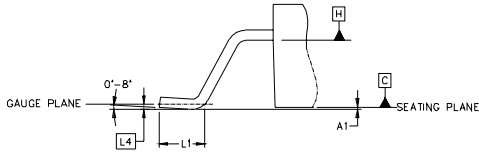
- 3 OUTLINE CONFORMS TO JEDEC OUTLINE TO-220AB.
- 4 HEATSINK & LEAD MEASUREMENTS DO NOT INCLUDE BURRS.

## TO-220AB Part Marking Information

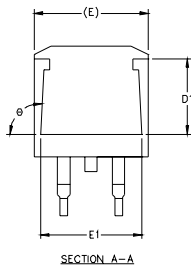
EXAMPLE: THIS IS AN IRF1010  
 LOT CODE 1789  
 ASSEMBLED ON WW 19, 1997  
 IN THE ASSEMBLY LINE "C"



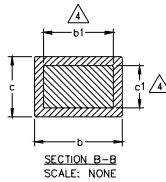
## D<sup>2</sup>Pak Package Outline



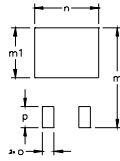
DETAIL "A"  
ROTATED 90°  
SCALE 8:1



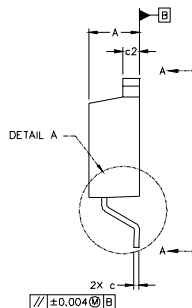
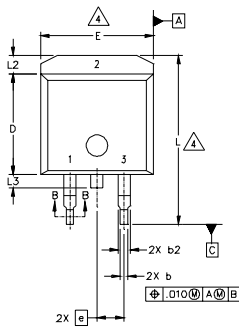
SECTION A-A



SECTION B-B  
SCALE: NONE



FOOT PRINT  
SCALE 2:1



**NOTES:**

1. DIMENSIONING AND TOLERANCING PER ASME Y14.5M-1994
2. DIMENSIONS ARE SHOWN IN MILLIMETERS [INCHES].
3. DIMENSION D & E DO NOT INCLUDE MOLD FLASH. MOLD FLASH SHALL NOT EXCEED 0.127 [.005"] PER SIDE. THESE DIMENSIONS ARE MEASURED AT THE OUTMOST EXTREMES OF THE PLASTIC BODY.
4. DIMENSION b1 AND c1 APPLY TO BASE METAL ONLY.
5. CONTROLLING DIMENSION: INCH.

## IRG/B/S/SL15B60KD

SYMBOL	DIMENSIONS				NOTES
	MILLIMETERS		INCHES		
	MIN.	MAX.	MIN.	MAX.	
A	4.06	4.83	.160	.190	4
A1		0.127		.005	
b	0.51	0.99	.020	.039	
b1	0.51	0.89	.020	.035	
b2	1.14	1.40	.045	.055	
c	0.43	0.63	.017	.025	4
c1	0.38	0.74	.015	.029	
c2	1.14	1.40	.045	.055	
D	8.51	9.65	.335	.380	3
D1	5.33		.210		
E	9.65	10.67	.380	.420	3
E1	6.22		.245		
e	2.54 BSC		.100 BSC		
L	14.61	15.88	.575	.625	
L1	1.78	2.79	.070	.110	
L2		1.65		.065	
L3	1.27	1.78	.050	.070	
L4	0.25 BSC		.010 BSC		
m	17.78		.700		
m1	8.89		.350		
n	11.43		.450		
o	2.08		.082		
p	3.81		.150		
θ	90°	93°	90°	93°	

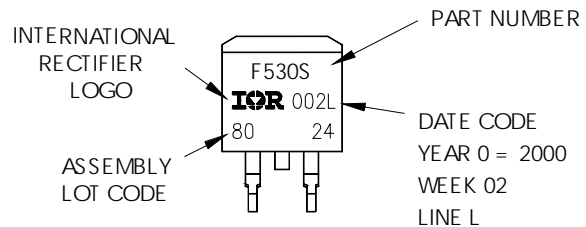
**LEAD ASSIGNMENTS**

HEXFET	IGBTs, CoPACK	DIODES
1.- GATE	1.- GATE	1.- ANODE *
2.- DRAIN	2.- COLLECTOR	2.- CATHODE
3.- SOURCE	3.- EMITTER	3.- ANODE

\* PART DEPENDENT.

## D<sup>2</sup>Pak Part Marking Information

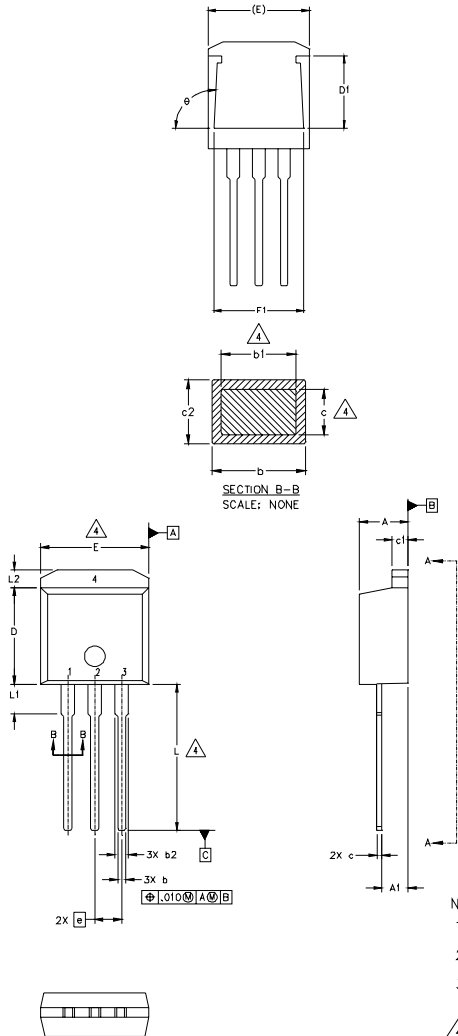
EXAMPLE: THIS IS AN IRF530S WITH  
LOT CODE 8024  
ASSEMBLED ON WW02, 2000  
IN THE ASSEMBLY LINE "L"



# IRG/B/S/SL15B60KD

International  
**IRF** Rectifier

## TO-262 Package Outline



SYMBOL	DIMENSIONS				NOTES
	MILLIMETERS		INCHES		
	MIN.	MAX.	MIN.	MAX.	
A	4.06	4.83	.160	.190	
A1	2.03	2.92	.080	.115	
b	0.51	0.99	.020	.039	
b1	0.51	0.89	.020	.035	4
b2	1.14	1.40	.045	.055	
c	0.38	0.63	.015	.025	4
c1	1.14	1.40	.045	.055	
c2	0.43	.063	.017	.029	
D	8.51	9.65	.335	.380	3
D1	5.33		.210		
E	9.65	10.67	.380	.420	3
E1	6.22		.245		
e	2.54 BSC		.100 BSC		
L	13.46	14.09	.530	.555	
L1	3.56	3.71	.140	.146	
L2		1.65		.065	

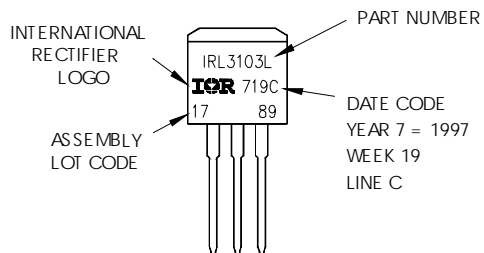
### LEAD ASSIGNMENTS

HEXFET	IGBT
1.- GATE	1- GATE
2.- DRAIN	2- COLLECTOR
3.- SOURCE	3- EMITTER
4.- DRAIN	4- COLLECTOR

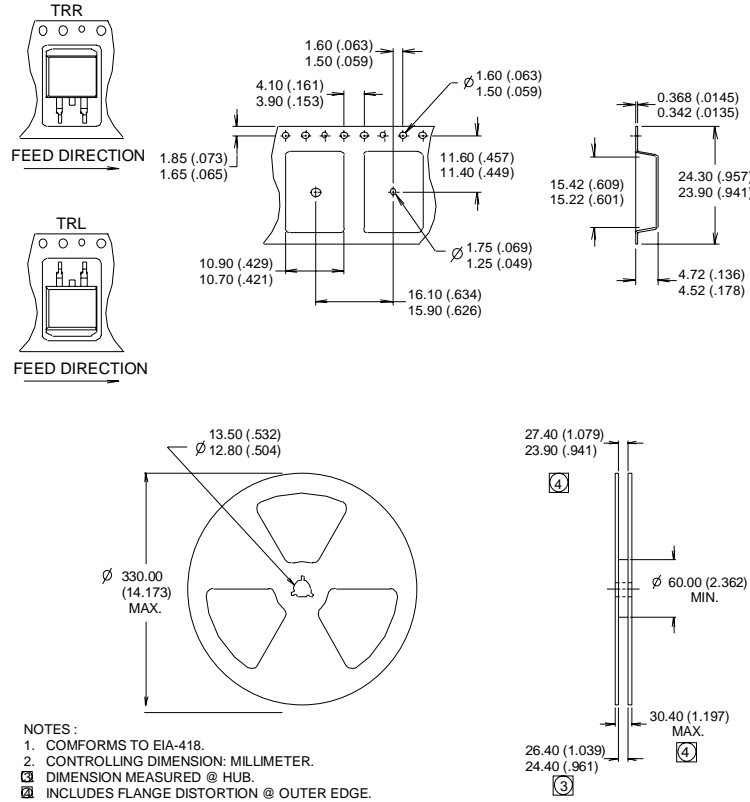
- NOTES:
1. DIMENSIONING AND TOLERANCING PER ASME Y14.5M-1994
  2. DIMENSIONS ARE SHOWN IN MILLIMETERS [INCHES].
  3. DIMENSION D & E DO NOT INCLUDE MOLD FLASH. MOLD FLASH SHALL NOT EXCEED 0.127 [".005"] PER SIDE. THESE DIMENSIONS ARE MEASURED AT THE OUTMOST EXTREMES OF THE PLASTIC BODY.
  4. DIMENSION b1 AND c1 APPLY TO BASE METAL ONLY.
  5. CONTROLLING DIMENSION: INCH.

## TO-262 Part Marking Information

EXAMPLE: THIS IS AN IRL3103L  
LOT CODE 1789  
ASSEMBLED ON WW 19, 1997  
IN THE ASSEMBLY LINE "C"



## D<sup>2</sup>Pak Tape & Reel Information



**Notes:**

- ① This is only applied to TO-220AB package
- ② This is applied to D<sup>2</sup>Pak, when mounted on 1" square PCB ( FR-4 or G-10 Material ).  
For recommended footprint and soldering techniques refer to application note #AN-994.
- ③ Energy losses include "tail" and diode reverse recovery.

TO-220 package is not recommended for Surface Mount Application

Data and specifications subject to change without notice.  
 This product has been designed and qualified for Industrial market.  
 Qualification Standards can be found on IR's Web site.

International  
**IR** Rectifier

**IR WORLD HEADQUARTERS:** 233 Kansas St., El Segundo, California 90245, USA Tel: (310) 252-7105  
 TAC Fax: (310) 252-7903

Visit us at [www.irf.com](http://www.irf.com) for sales contact information. 6/02

This datasheet has been download from:

[www.datasheetcatalog.com](http://www.datasheetcatalog.com)

Datasheets for electronics components.