



**DC COMPONENTS CO., LTD.**

RECTIFIER SPECIALISTS

**FSM101  
THRU  
FSM107**

**TECHNICAL SPECIFICATIONS OF SURFACE MOUNT FAST RECOVERY RECTIFIER**

**VOLTAGE RANGE - 50 to 1000 Volts**

**CURRENT - 1.0 Ampere**

**FEATURES**

- \* Ideal for surface mounted applications
- \* Low leakage current
- \* Fast switching for high efficiency
- \* Glass passivated junction

**MECHANICAL DATA**

- \* Case: Molded plastic
- \* Epoxy: UL 94V-0 rate flame retardant
- \* Terminals: Solder plated solderable per MIL-STD-202E, Method 208 guaranteed
- \* Polarity: Color band denotes cathode end
- \* Mounting position: Any
- \* Weight: 0.12 gram

**MAXIMUM RATINGS AND ELECTRICAL CHARACTERISTICS**

Ratings at 25 °C ambient temperature unless otherwise specified.  
Single phase, half wave, 60 Hz, resistive or inductive load.  
For capacitive load, derate current by 20%.



**SM-1(DO-213AB)**

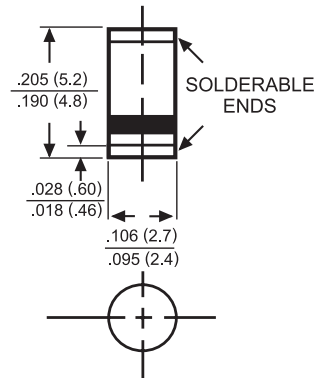

Dimensions in inches and (millimeters)

	SYMBOL	FSM101	FSM102	FSM103	FSM104	FSM105	FSM106	FSM107	UNITS
Maximum Recurrent Peak Reverse Voltage	V <sub>RRM</sub>	50	100	200	400	600	800	1000	Volts
Maximum RMS Voltage	V <sub>RMS</sub>	35	70	140	280	420	560	700	Volts
Maximum DC Blocking Voltage	V <sub>DC</sub>	50	100	200	400	600	800	1000	Volts
Maximum Average Forward Rectified Current at T <sub>A</sub> = 55°C	I <sub>O</sub>	1.0							Amps
Peak Forward Surge Current 8.3 ms single half sine-wave superimposed on rated load (JEDEC Method)	I <sub>FSM</sub>	30							Amps
Maximum Forward Voltage at 1.0A DC	V <sub>F</sub>	1.3							Volts
Maximum DC Reverse Current at Rated DC Blocking Voltage	I <sub>R</sub>	@ T <sub>A</sub> = 25°C							uAmps
		@ T <sub>A</sub> = 125°C							
Maximum Reverse Recovery Time (Note 3)	t <sub>rr</sub>	150				250	500		nSec
Maximum Thermal Resistance (Note 2)	R <sub>θJL</sub>	30							°C/W
Typical Junction Capacitance (Note 1)	C <sub>J</sub>	15							pF
Operating and Storage Temperature Range	T <sub>J</sub> , T <sub>STG</sub>	-65 to + 175							°C

NOTES : 1. Measured at 1.0 MHz and applied reverse voltage of 4.0VDC  
 2. Thermal resistance (Junction to Ambient), .24in<sup>2</sup> (6.0mm<sup>2</sup>)copper pads to each terminal.  
 3. Test Conditions: I<sub>F</sub> = 0.5A, I<sub>R</sub> = 1.0A, I<sub>RR</sub> = 0.25A

# RATING AND CHARACTERISTIC CURVES ( FSM101 THRU FSM107 )

FIG. 1 - TYPICAL FORWARD CURRENT DERATING CURVE

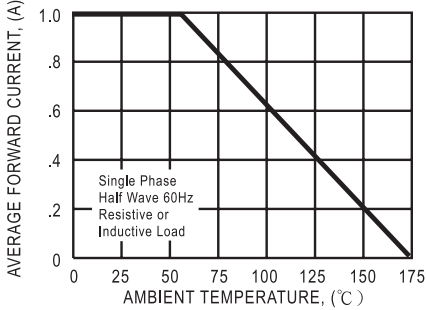

FIG. 2 - MAXIMUM NON-REPETITIVE FORWARD SURGE CURRENT

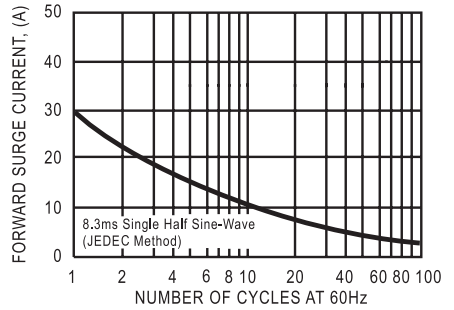

FIG. 3 - TYPICAL REVERSE CHARACTERISTICS

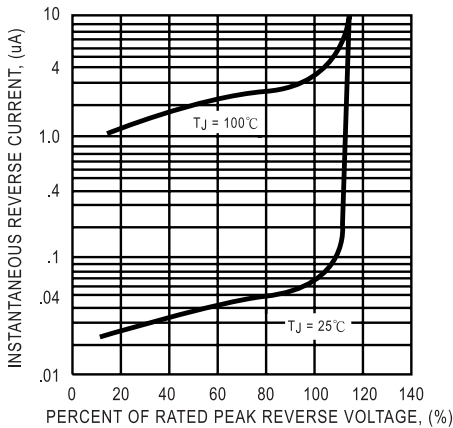

FIG. 4 - TYPICAL INSTANTANEOUS FORWARD CHARACTERISTICS

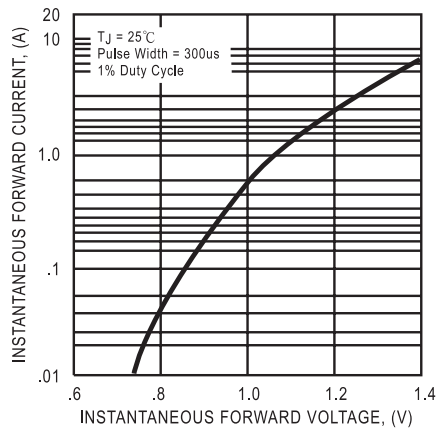
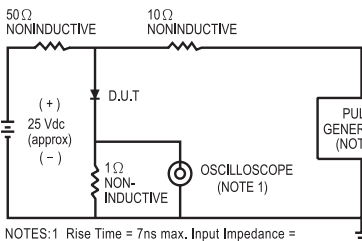

FIG. 5 - TEST CIRCUIT DIAGRAM AND REVERSE RECOVERY TIME CHARACTERISTIC



NOTES: 1. Rise Time = 7ns max. Input Impedance = 1 megohm, 22 pF.  
 2. Rise Time = 10ns max. Source Impedance = 50 ohms.

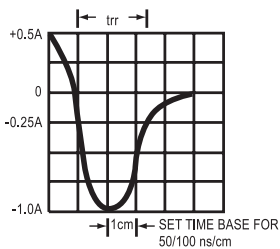
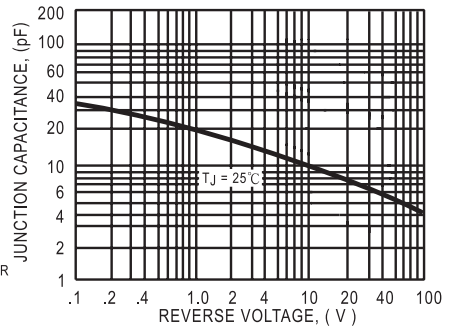

FIG. 6 - TYPICAL JUNCTION CAPACITANCE



DC COMPONENTS CO., LTD.