

TOSHIBA BIPOLAR LINEAR INTEGRATED CIRCUIT SILICON MONOLITHIC

# TA1201AN

## I<sup>2</sup>C BUS CONTROL NTSC 1CHIP COLOR TV IC

TA1201AN provides PIF, SIF, Video, Chroma and Deflection circuit for NTSC Color TV. TA1201AN also provides Audio-Video Switch and Text interface. TA1201AN combine these functions in a 56pin dual-in-line shrink-type plastic package. TA1201AN realizes rationalization of various alignments and controls by bus control system.

### FEATURES

#### PIF Circuit

- PLL Type IF Demodulation (Bus alignment)
- Adjustment Free AFT without Tank Coil
- RF AGC Output (Delay point : Bus alignment)
- Dual Time Constant Fast AGC

#### Video Circuit

- Black Stretcher
- DC Restoration Circuit
- D.L. Aperture Compensate Circuit (Bus Control)
- Internal Filter Auto-adjust Circuit (Fsc link type)
- Uni-color Circuit (Bus control)
- 3.58MHz Trap Filter Circuit (Bus on / off)
- Y Delay Line Circuit

#### Chroma Circuit

- Color Control Circuit (Bus control)
- Tint Control Circuit (Bus control)
- B.P.F./T.O.F. Circuit (Bus select)
- Included ACC/Killer Filter

#### SIF Circuit

- Inter Carrier SIF System
- External Sound Select Switch (Bus select)
- Attenuator Circuit (Bus control)

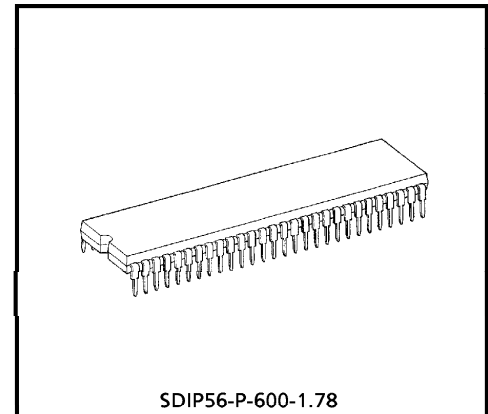

Weight : 5.55g (Typ.)

#### TEXT Circuit

- Linear RGB Input
- Cut Off / Drive Adjustment (Bus adjustment)
- RGB Primary Color Output

#### Deflection Circuit

- Auto-slicer Type High Performance Sync. Separation Circuit
- Adjustment Free Countdown System
- Sync. Separation Output
- X-ray Protect Circuit
- Vertical Ramp Output
- Dual Time Constant AFC Circuit
- Horizontal and Vertical Position Adjustment (Bus adjustment)
- Vertical Amplitude Adjustment (Bus adjustment)

961001EBA2

- TOSHIBA is continually working to improve the quality and the reliability of its products. Nevertheless, semiconductor devices in general can malfunction or fail due to their inherent electrical sensitivity and vulnerability to physical stress. It is the responsibility of the buyer, when utilizing TOSHIBA products, to observe standards of safety, and to avoid situations in which a malfunction or failure of a TOSHIBA product could cause loss of human life, bodily injury or damage to property. In developing your designs, please ensure that TOSHIBA products are used within specified operating ranges as set forth in the most recent products specifications. Also, please keep in mind the precautions and conditions set forth in the TOSHIBA Semiconductor Reliability Handbook.
- The products described in this document are subject to foreign exchange and foreign trade control laws.
- The information contained herein is presented only as a guide for the applications of our products. No responsibility is assumed by TOSHIBA CORPORATION for any infringements of intellectual property or other rights of the third parties which may result from its use. No license is granted by implication or otherwise under any intellectual property or other rights of TOSHIBA CORPORATION or others.
- The information contained herein is subject to change without notice.



**TERMINAL FUNCTION**

PIN No.	PIN NAME	FUNCTION	INTERFACE CIRCUIT
1 2	Sound Output	This terminal is for Sound Output. The maximum flow out current of these terminals is 3.6mA. So, the minimum load resistor is 1kΩ.	
3	RF AGC	This terminal is for RF AGC output.	
4	SIF Tank Coil	This terminal is for connecting SIF detect tank coil. This terminal is for Sound Mute Switch, too. If this terminal is connected to GND, the sound output is muted.	
5	AGC Filter	This terminal is for PIF 2nd AGC filter.	
6	PIF GND	This terminal is for GND of PIF circuit.	—
7 8	PIF Input	This terminal is for IF input. The typical input value is 90dBμV.	

PIN No.	PIN NAME	FUNCTION	INTERFACE CIRCUIT
9	PIF V <sub>CC</sub>	This terminal is for V <sub>CC</sub> of PIF circuit.	—
10	Loop Filter	This terminal is for PIF PLL loop filter.	
11	APC Filter	This terminal is for APC filter of f <sub>SC</sub> oscillation.	
12	VCXO	This terminal is for X'tal of 3.58MHz VCXO.	
13	GND	This terminal is for V/C/D GND.	—
14	Fast Blanking	This terminal is for fast blanking of RGB input.	

PIN No.	PIN NAME	FUNCTION	INTERFACE CIRCUIT
15 16 17	Analog RGB Input	These terminals are for RGB signal input.	
18	Digital VCC	This terminal is for VCC of digital circuit.	—
19 20 21	RGB Output	These terminals are for RGB primary color signal output.	
22	Vertical Output	This terminal is for vertical pulse output.	
23 24	NFB, Vertical Ramp.	These terminals are for NFB input and vertical ramp output.	

PIN No.	PIN NAME	FUNCTION	INTERFACE CIRCUIT
25	Vertical Sync. Separation Filter	This terminal is for vertical sync. separation filter.	
26	H. V <sub>CC</sub>	This terminal is for V <sub>CC</sub> of horizontal circuit.	—
27 28	SCL, SDA	These terminals are for input and output of I <sup>2</sup> C Bus.	
29	X-RAY	This terminal is for input of X-RAY protect circuit. The threshold voltage is 3.5V (Typ.). If this terminal is applied the voltage that is more than threshold voltage, the X-RAY protect circuit make horizontal output a low.	
30	Fly-back Pulse Input	This terminal is for Fly-back Pulse input. The Fly-back Pulse is the reference of AFC circuit, gate pulse and so on. The current needs to keep under 1mA.	
31	Sync. Pulse Output	This terminal is for Sync. pulse output.	

PIN No.	PIN NAME	FUNCTION	INTERFACE CIRCUIT
32	Horizontal Output	This terminal is for horizontal pulse output.	
33	H. AFC	This terminal is for horizontal AFC filter. The AFC circuit fits the phase between inputted horizontal sync. signal and horizontal pulse which is made by countdowning 32f <sub>H</sub> .	
34	32f <sub>H</sub> VCO	This terminal is for connecting ceramic oscillator. That constitutes 32f <sub>H</sub> (503kHz) oscillation circuit. The CSB503F30 (Murata) is recommended.	
35	D. GND	This terminal is for GND of digital circuit.	—
36	A.B.L.	This terminal is for A.B.L. circuit.	
37	TV Input	This terminal is for input of PIF detected signal. The typical input amplitude is 1.0V <sub>p-p</sub> .	

PIN No.	PIN NAME	FUNCTION	INTERFACE CIRCUIT
38	A.C.L.	This terminal is for ACL circuit.	<p>The diagram shows a transistor circuit. The input terminal (38) is connected to the base of a transistor through a 1kΩ resistor. The base is also connected to a 100 μA current source. The emitter is connected to ground through a 100 μA current source. The collector is connected to a 10kΩ resistor, which is in turn connected to a 3.4V supply through another 10kΩ resistor. The output terminal (46) is connected to the collector. There are also two diodes connected to the input and output lines.</p>
39	External Video Input	This terminal is for input of external video signal.	<p>The diagram shows a differential amplifier circuit. The input terminal (39) is connected to the base of one of two transistors. The other base is connected to ground through a resistor. The emitters are connected to a common emitter resistor, which is connected to ground through a current source. The collectors are connected to a 3.4V supply through resistors. The output terminal (46) is connected to one of the collectors. There are also two diodes connected to the input and output lines.</p>
40	Black Peak Detection	This terminal is for filter of black peak detection.	<p>The diagram shows a transistor circuit. The input terminal (40) is connected to the base of a transistor through a 3.3kΩ resistor. The base is also connected to a feedback loop consisting of an 8kΩ resistor and a 1kΩ resistor. The emitter is connected to ground through a 2.8kΩ resistor. The collector is connected to a 3.4V supply through a 1.8kΩ resistor. The output terminal (46) is connected to the collector. There are also two diodes connected to the input and output lines.</p>
41	Video Switch Output	This terminal is for output of video switch which selects TV signal or external video. Amp. Gain ; Min. 1.7 Typ. 1.9, Max. 2.1	<p>The diagram shows a transistor circuit. The input terminal (41) is connected to the base of a transistor through a 50Ω resistor. The base is also connected to a feedback loop consisting of a 100Ω resistor and a 200Ω resistor. The emitter is connected to ground through a 75 μA current source. The collector is connected to a 3.4V supply through a resistor. The output terminal (46) is connected to the collector. There are also two diodes connected to the input and output lines.</p>
42	D.C. Restoration	This terminal is for filter of APL detection.	<p>The diagram shows a differential amplifier circuit. The input terminal (42) is connected to the base of one of two transistors through a 2kΩ resistor. The other base is connected to ground through a 3kΩ resistor. The emitters are connected to a common emitter resistor, which is connected to ground through a current source. The collectors are connected to a 3.4V supply through 2.5kΩ resistors. The output terminal (46) is connected to one of the collectors. There are also two diodes connected to the input and output lines.</p>



PIN No.	PIN NAME	FUNCTION	INTERFACE CIRCUIT															
43	Y Input	This terminal is for Y signal input. The typical input amplitude is 1.0V <sub>p-p</sub> .																
44	A.F.T.	This terminal is for AFT output. Monitor signal output mode can be selected via Bus. <table border="1" data-bbox="518 907 901 1115"> <thead> <tr> <th>B<sub>0</sub></th> <th>B<sub>1</sub></th> <th>OUTPUT</th> </tr> </thead> <tbody> <tr> <td>0</td> <td>0</td> <td>AFT</td> </tr> <tr> <td>0</td> <td>1</td> <td>TEST purpose only</td> </tr> <tr> <td>1</td> <td>0</td> <td>B</td> </tr> <tr> <td>1</td> <td>1</td> <td>RFAGC / 2</td> </tr> </tbody> </table>	B <sub>0</sub>	B <sub>1</sub>	OUTPUT	0	0	AFT	0	1	TEST purpose only	1	0	B	1	1	RFAGC / 2	
B <sub>0</sub>	B <sub>1</sub>	OUTPUT																
0	0	AFT																
0	1	TEST purpose only																
1	0	B																
1	1	RFAGC / 2																
45	Chroma Input	This terminal is for chrominance signal input. The typical input signal amplitude is 286mV <sub>p-p</sub> (at burst signal). This IC is to go to test mode with this terminal voltage higher than 4.5V.																
46	V/C/D V <sub>CC</sub>	This terminal is for V <sub>CC</sub> of video, Chroma and Deflection circuit.	—															
47	TV Detection Output	This terminal is for PIF detected signal output.																
48	S.I.F. V <sub>CC</sub>	This terminal is for V <sub>CC</sub> of SIF circuit.	—															

PIN No.	PIN NAME	FUNCTION	INTERFACE CIRCUIT
49 50	P.I.F. Tank Coil	These terminals are for connecting a tank coil of PIF detection circuit. TOKO Corp. products 292GJAS-7475BS (45.75MHz), 292GJAS-7476BS (58.75MHz) are recommended.	
51	S.I.F. GND	This terminal is for GND of SIF circuit.	—
52	Limiter Input	This terminal is for input of SIF limiter amplifier circuit.	
53	TV Audio Signal Input	This terminal is for input of SIF detected signal. This terminal is connected to pin 54 via capacitor.	
54	De-emphasis	This terminal is for filter of SIF de-emphasis.	
55 56	External Audio Input	These terminals are for external audio input.	

Slave Address : 88H

FUNCTION	SUB ADD.	DATA							
		D7	D6	D5	D4	D3	D2	D1	D0
Color	00	TRAP (0)	(0)	(0)	(0)	(0)	(0)	(0)	(0)
TINT	01	BPF (1)	(1)	(0)	(0)	(0)	(0)	(0)	(0)
Brightness	02	A SW (0)	(0)	(0)	(0)	(0)	(0)	(0)	(0)
Uni-Color	03	BLK (0)	(0)	(0)	(0)	(0)	(0)	(0)	(0)
Sharpness	04	MUTE (0) (1)		(1)	(0)	(0)	(0)	(0)	(0)
Hor. /Ver. Phase	05	Ver. Phase (0) (0) (0)			Hor. Phase (1) (0) (0) (0) (0)				
Sound ATT	06	B <sub>0</sub> (0)	B <sub>1</sub> (0)	(0)	(0)	(0)	(0)	(0)	(0)
Sound Balance	07	B <sub>2</sub> (0)	B <sub>3</sub> (0)	(1)	(0)	(0)	(0)	(0)	(0)
RF AGC	08	B <sub>4</sub> (0)	V SW (0)	(0)	(0)	(0)	(0)	(0)	(0)
Ver. Amplitude	09	AFC (0)	WPL (0)	(1)	(0)	(0)	(0)	(0)	(0)
PIF VCO	0A	60Hz (0)	(1)	(0)	(0)	(0)	(0)	(0)	(0)
R Cut-off	0B	(0)	(0)	(0)	(0)	(0)	(0)	(0)	(0)
G Cut-off	0C	(0)	(0)	(0)	(0)	(0)	(0)	(0)	(0)
B Cut-off	0D	(0)	(0)	(0)	(0)	(0)	(0)	(0)	(0)
G Gain	0E	(0)	(0)	(0)	(0)	(0)	(0)	(0)	(0)
B Gain	0F	(0)	(0)	(0)	(0)	(0)	(0)	(0)	(0)

(0), (1) Default Value

FUNCTION	RANGE (MIN.~MAX.)	DEFAULT
Color	- 60~0dB	- 60dB
TINT	± 42°	0°
Brightness	1.34~2.6~3.86V	1.34V
Uni-Color	- 24~0dB	- 24dB
Sharpness	- 18~6dB~14dB (4MHz Gain)	6dB
Sound ATT	- 85~6dB	- 85dB
Sound Balance	- 70~0~70dB	0dB
RF AGC	65dB <sub>μ</sub> ~105dB <sub>μ</sub> V (0.6dB / bit)	0dB
Ver. Amplitude	1.6~2.4V	Center
PIF VCO	± 2.2MHz (35kHz / bit)	Center
RGB Cut-off	- 0.4~0.4V	- 0.4V
GB Gain	- 3.1~3.1dB	- 3.1dB

FUNCTION	RANGE (MIN.~MAX.)	DEFAULT
3.58 Trap	(0) : On / (1) : Off	On
BPF	(0) : Band Pass Filter / (1) : Take Off Filter	TOF
A, V SW	(0) : TV Mode / (1) : EXT. Mode	TV
BLK	(0) : BLK On / (1) : BLK Off	On
MUTE	(00) : Off / (01) : Y MUTE / (10) : Hout Stop / (11) : Y MUTE + V Stop	(01)
H. AFC	(0) : AFC2 Normal / (1) : AFC2 × 3	(0)
WPL	(0) : On / (1) : Off	Off
60Hz SW	(0) : Normal / (1) : V Frequency 60Hz Fix	Normal
B <sub>0</sub> , B <sub>1</sub> (Monitor)	Pin 44's output is selectable. (00) : AFT Voltage / (01) : Test Mode / (10) : Blue Output / (11) : Half of RF AGC Voltage	AFT Voltage
B <sub>2</sub> , B <sub>3</sub> , B <sub>4</sub> (Test Mode)	Bits for Test Mode. Use this IC with these bits (000).	(000)

Read Mode

D7	D6	D5	D4	D3	D2	D1	D0
POR	AFT	IF Lock	AFT	—	V Lock	H Lock	X-RAY

FUNCTION	CONTENTS
POR (Power On Reset)	(0) : SECOND / (1) : FIRST
AFT	Refer to Following Figure
IF LOCK	(0) : LOCK OUT / (1) : LOCK IN
V LOCK	(0) : LOCK IN / (1) : LOCK OUT Det. Window : 262H~263H
H LOCK	(0) : LOCK OUT / (1) : LOCK IN This function is forced to unlock at V <sub>p</sub> , so data is valid after 50H.
X-RAY	(0) : X-RAY OFF / (1) : X-RAY ON

- Vertical Phase (3bit)  
This mode is for changing vertical output timing.  
(Vertical picture position is changed 0~7H as right Table.)
- Horizontal Phase (5bit)  
This mode is for changing horizontal picture position.  
Horizontal output phase is changed ±3μs as maximum.
- AFT Read Bus

D7	D6	D5	MODE
0	0	0	Reference
0	0	1	1H Delay
0	1	0	2H Delay
0	1	1	3H Delay
1	0	0	4H Delay
1	0	1	5H Delay
1	1	0	6H Delay
1	1	1	7H Delay

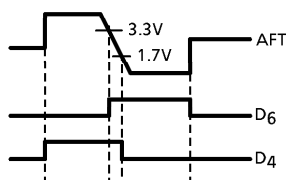

**I<sup>2</sup>C BUS CONTROLLED FORMAT SUMMARY**

Bus controlled format of TA1201AN is based on I<sup>2</sup>C Bus Control format of Philips.

**Data Transfer Format**

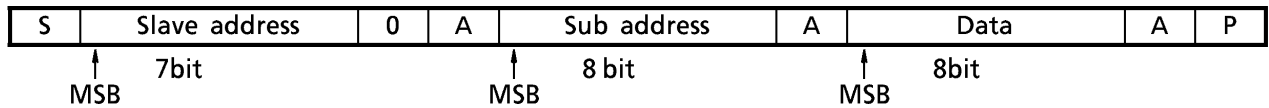

S : Start Condition  
 P : Stop Condition  
 A : Acknowledge

**(1) Start and Stop Condition**

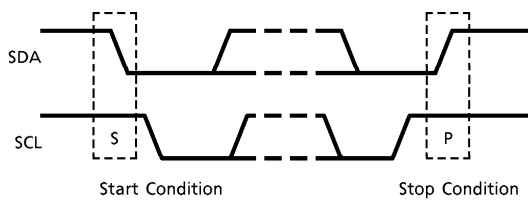

**(2) Bit Transfer**

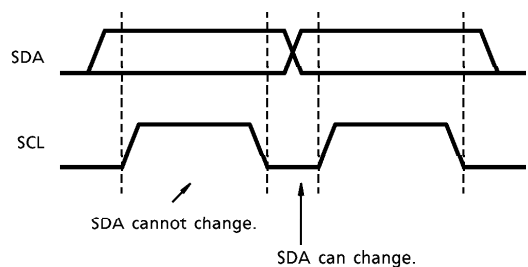

**(3) Acknowledge**

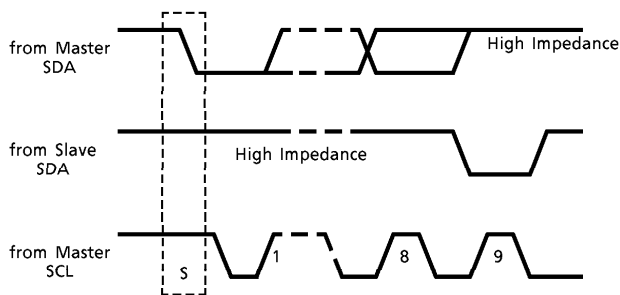

**(4) Slave Address**

A6	A5	A4	A3	A2	A1	A0	R/W
1	0	0	0	1	0	0	0

Purchase of TOSHIBA I<sup>2</sup>C components conveys a license under the Philips I<sup>2</sup>C Patent Rights to use these components in an I<sup>2</sup>C system, provided that the system conforms to the I<sup>2</sup>C Standard Specification as defined by Philips.

## MAXIMUM RATINGS (Ta = 25°C)

CHARACTERISTIC	SYMBOL	RATING	UNIT
Power Supply Voltage	V <sub>CC</sub>	12	V
Power Dissipation	P <sub>Dmax</sub>	2.19 (Note1)	W
Input Terminal Voltage	V <sub>in</sub>	GND - 0.3~V <sub>CC</sub> + 0.3	V
Input Signal Amplitude	e <sub>in</sub>	4	V <sub>p-p</sub>
Operating Temperature	T <sub>opr</sub>	-20~65	°C
Storage Temperature	T <sub>stg</sub>	-55~150	°C

(Note1) When using the device at above Ta = 25°C, decrease the power dissipation by 17.5mW for each increase of 1°C.

(Note2) As this IC is weak in a surge voltage, handle it with care from being damage.

## RECOMMENDED OPERATING CONDITION

CHARACTERISTIC	SYMBOL	MIN.	TYP.	MAX.	UNIT	REMARKS
PIF Power Supply Voltage	V <sub>CCP</sub>	8.5	9.0	9.5	V	—
SIF Power Supply Voltage	V <sub>CCS</sub>	8.5	9.0	9.5	V	—
V/C/D Power Supply Voltage	V <sub>CCV</sub>	8.5	9.0	9.5	V	—
H.V <sub>CC</sub> Power Supply Voltage	H.V <sub>CC</sub>	8.5	9.0	9.5	V	—
D.V <sub>CC</sub> Power Supply Voltage	D.V <sub>CC</sub>	2.7	3.3	3.8	V	—
TV External Video Input Level	V <sub>in37/39</sub>	—	1.0	—	V <sub>p-p</sub>	including sync.
Standard Video Input Level	V <sub>in43</sub>	—	1.0	—	V <sub>p-p</sub>	including sync.
Standard Chroma Input Level	V <sub>in45</sub>	—	286	—	mV <sub>p-p</sub>	at burst signal
FBP Width	T <sub>FBP</sub>	10	12	—	μs	V <sub>th</sub> = 1.4V, V <sub>CC</sub> - 1.4V
FBP Input Flow in Current	I <sub>FBPmax</sub>	—	—	2	mA	—
PIF Output Load Resister	R <sub>OP</sub>	2	8.2	—	kΩ	—
SIF Output Load Resister	R <sub>OS</sub>	1	8.2	—	kΩ	—
RGB Output Load Resister	R <sub>ORGB</sub>	—	1.8	—	kΩ	—
Horizontal Output Load Resister	R <sub>HOUT</sub>	330	800	—	Ω	maximum 10mA
Vertical Output Load Resister	R <sub>VOUT</sub>	4.1	5.7	—	kΩ	—
Sync. Separation Output Flow In Current	I <sub>syncmax</sub>	—	—	1	mA	—

## ELECTRICAL CHARACTERISTICS

DC CHARACTERISTICS (Unless Otherwise Specified,  $V_{CC} = 9V$ , H.  $V_{CC} = 9V$ ,  $T_a = 25^\circ C$ )

PIN No.	CHARACTERISTIC	SYMBOL	TEST CIR-CUIT	TEST CONDITION	MIN.	TYP.	MAX.	UNIT
1	Sound Output	$V_1$	—	—	3.20	3.70	4.20	V
2	Sound Output	$V_2$	—	—	3.20	3.70	4.20	V
3	RF AGC	$V_3$	—	—	—	0.00	0.50	V
4	SIF TANK	$V_4$	—	—	—	—	—	V
5	AGC Filter	$V_5$	—	—	7.00	7.50	8.00	V
6	PIF GND	GND	—	—	—	0.00	—	V
7	PIF Input	$V_7$	—	—	1.50	2.00	2.50	V
8	PIF Input	$V_8$	—	—	—	0.00	0.50	V
9	PIF $V_{CC}$	$V_{CC}$	—	—	—	9.00	—	V
10	Loop Filter	$V_{10}$	—	—	—	4.50	—	V
11	APC Filter	$V_{11}$	—	—	6.00	6.50	7.00	V
12	VCXO	$V_{12}$	—	—	5.30	5.80	6.30	V
13	V/C/D GND	GND	—	—	—	0.00	—	V
14	F-BLK	$V_{14}$	—	—	—	0.00	—	V
15	Analog R Input	$V_{15}$	—	—	4.40	4.90	5.40	V
16	Analog G Input	$V_{16}$	—	—	4.40	4.90	5.40	V
17	Analog B Input	$V_{17}$	—	—	4.40	4.90	5.40	V
18	D. $V_{CC}$	$V_{CC}$	—	—	—	3.30	—	V
19	R Output	$V_{19}$	—	BRT, C. O Cent	2.40	2.70	2.90	V
20	G Output	$V_{20}$	—	BRT, C. O Cent	2.40	2.70	2.90	V
21	B Output	$V_{21}$	—	BRT, C. O Cent	2.40	2.70	2.90	V
22	$V_{out}$	$V_{22}$	—	—	—	—	—	—
23	NFB	$V_{23}$	—	—	—	—	—	—
24	V. Ramp	$V_{24}$	—	—	—	—	—	—
25	V SEPA	$V_{25}$	—	—	5.80	6.30	6.80	V
26	H. $V_{CC}$	$V_{26}$	—	—	—	9.00	—	V
27	SCL	$V_{27}$	—	—	4.50	5.00	5.50	V
28	SDA	$V_{28}$	—	—	4.50	5.00	5.50	V
29	X-RAY	$V_{29}$	—	—	—	0.00	—	V
30	FBP Input	$V_{30}$	—	—	—	—	—	—
31	Sync. Output	$V_{31}$	—	—	—	—	—	—
32	H. Output	$V_{32}$	—	—	—	—	—	—
33	H. AFC	$V_{33}$	—	—	7.00	7.50	8.00	V
34	32f <sub>H</sub> VCO	$V_{34}$	—	—	5.50	6.00	6.50	V
35	D. GND	GND	—	—	—	0.00	—	V
36	ABL	$V_{36}$	—	BRT, COL Cent	2.90	3.40	3.90	V
37	TV Input	$V_{37}$	—	—	2.90	3.00	3.90	V
38	ACL	$V_{38}$	—	BRT, COL Cent	2.90	3.40	3.90	V

PIN No.	CHARACTERISTIC	SYMBOL	TEST CIR-CUIT	TEST CONDITION	MIN.	TYP.	MAX.	UNIT
39	EXT. Video Input	V <sub>39</sub>	—	—	1.10	1.60	2.10	V
40	Black DET	V <sub>40</sub>	—	—	6.10	6.60	7.10	V
41	AV/SW Output	V <sub>41</sub>	—	—	1.80	2.30	2.80	V
42	DC Rest	V <sub>42</sub>	—	—	5.50	6.00	6.50	V
43	Y Input	V <sub>43</sub>	—	—	4.00	4.50	5.00	V
44	AFT	V <sub>44</sub>	—	—	2.00	2.50	3.00	V
45	Chroma Input	V <sub>45</sub>	—	—	1.60	1.85	2.10	V
46	V/C/D V <sub>CC</sub>	V <sub>46</sub>	—	—	—	9.00	—	V
47	TV DET. Output	V <sub>47</sub>	—	—	4.70	5.20	5.70	V
48	SIF V <sub>CC</sub>	V <sub>CC</sub>	—	—	—	9.00	—	V
49	PIF Tank	V <sub>49</sub>	—	—	—	—	—	V
50	PIF Tank	V <sub>50</sub>	—	—	—	—	—	V
51	SIF GND	V <sub>CC</sub>	—	—	—	0.00	—	V
52	Limiter Input	V <sub>52</sub>	—	—	—	0.00	0.50	V
53	Audio TV Input	V <sub>53</sub>	—	—	2.50	3.00	3.50	V
54	De-emphasis	V <sub>54</sub>	—	Pin4 GND	4.00	4.50	5.00	V
55	EXT. Audio Input	V <sub>55</sub>	—	—	2.50	3.00	3.50	V
56	EXT. Audio Input	V <sub>56</sub>	—	—	2.50	3.00	3.50	V

## Current Consumption

CHARACTERISTIC	SYMBOL	TEST CONDITION	MIN.	TYP.	MAX.	UNIT
IF Power Supply Current	I <sub>cci</sub>	—	32.8	46	52.0	mA
V/C/D Power Supply Current	I <sub>ccv</sub>	—	52.7	71	76.8	mA
H. V <sub>CC</sub> Power Supply Current	I <sub>cch</sub>	—	10.7	14	18.4	mA
D. V <sub>CC</sub> Power Supply Current	I <sub>ccd</sub>	—	5.2	10	11.6	mA



**AC CHARACTERISTICS** (Unless Otherwise Specified,  $V_{CC} = 9V$ , H.  $V_{CC} = 9V$ ,  $T_a = 25^\circ C$ )  
 PIF

CHARACTERISTIC	SYMBOL	TEST CIRCUIT	TEST CONDITION	MIN.	TYP.	MAX.	UNIT
Video Detected Output level	$V_{O1}$	—	Note 1	1.7	2.0	2.3	$V_{p-p}$
	$V_{O2}$			2.0	2.5	3.0	
Input Sensitivity	$V_{IN\ MIN}$	—	Note 2	—	42	—	$dB_{\mu V}$
	$V_{IN\ MAX}$			100	107	—	
Sync Tip Level	$V_{SYNC}$	—	Note 3	2.6	2.9	3.2	V
Output Level for No Input	$V_{IF}$	—	Note 4	4.8	5.2	5.6	V
Differential Gain	DG	—	Note 5	—	2	5	%
Differential Phase	DP			—	2	5	
PIF Output Frequency Characteristic	$f_c$	—	Note 6	5	7	—	MHz
Carrier wave Compression Ratio	CR	—	Note 7	50	55	—	dB
2nd Harmonics Compression Ratio	HR			50	55	—	
PIF Input Resistance	$R_{iPIF}$	—	Note 8	—	1.5	—	$k\Omega$
PIF Input Capacitance	$C_{iPIF}$			—	3.8	—	pF
S/N	S/N	—	Note 9	52	55	—	dB
920kHz Beat	$I_{920}$	—	Note 10	42	45	—	dB
IF AGC Range	$RW_{AGC}$	—	Note 11	61	65	69	dB
IF AGC Voltage	$V_{5MEAN}$	—	Note 12	4.2	4.5	4.8	V
	$V_{5MAX}$			7.4	7.6	—	
	$V_{5MIN}$			—	3.8	—	
RF AGC Voltage	$V_{3MAX}$	—	Note 13	7.7	8.2	—	V
	$V_{3MIN}$			—	0	0.5	
RF AGC Control Range	$\Delta GR_{FAGC}$	—	Note 14	35	40	—	dB
AFT Center Voltage	$V_{4CENT}$	—	Note 15	2.2	2.5	2.8	V
AFT Voltage	$V_{4MAX}$	—	Note 16	4.4	4.8	—	V
	$V_{4MIN}$			—	0.2	0.5	
AFT Sensitivity	$\mu AFT$	—	Note 17	—	40	—	$kHz/V$
AFT Output Resistance	$R_{AFTOUT}$	—	Note 18	40	50	60	$k\Omega$
PIF VCO Control Sensitivity	$\beta_{IFVCO}$	—	Note 19	2.0	2.5	—	MHz/V
PIF VCO Pull-in Range	$f_{ph}$	—	Note 20	1.0	1.5	—	MHz
	$f_{pl}$			1.0	1.5	—	
PIF VCO Control Range	$\Delta f_{PIFVCO}$	—	Note 21	—	4.4	—	MHz

## SIF

CHARACTERISTIC	SYMBOL	TEST CIRCUIT	TEST CONDITION	MIN.	TYP.	MAX.	UNIT
Sound Output Level	V <sub>AAC</sub>	—	Note 22	400	500	600	mV <sub>rms</sub>
	V <sub>ADC</sub>	—		—	4.5	—	V
Sound Distortion	V <sub>AUDIO</sub>	—	Note 23	—	0.3	1.0	%
AMR	AMR	—	Note 24	50	60	—	dB
Limiting Sensitivity	V <sub>LIM</sub>	—	Note 25	—	35	—	dB $\mu$ V
Sound Output Frequency Characteristics	f <sub>AUDIOH</sub>	—	Note 26	—	130	—	kHz
	f <sub>AUDIOL</sub>	—		—	-130	—	
Sound Output Resistance	R <sub>SO</sub>	—	Note 27	24	30	36	k $\Omega$

## ATT

ATT Gain	G <sub>ATTMAXE</sub>	—	Note 28	-2.0	0.0	2.0	dB
	G <sub>ATTMAXT</sub>			4.0	6.0	8.0	
	G <sub>ATTMEAN</sub>			-16	-12	-9	
	G <sub>ATTMIN</sub>			-99	-85	—	
DC Voltage Drift	V <sub>1VAR</sub>	—	Note 29	—	—	50	mV
	V <sub>1DC</sub>			3.2	3.7	4.2	V
Input Impedance	R <sub>i53</sub>	—	Note 30	—	30	—	k $\Omega$
	R <sub>i55</sub>			—	47	—	
Balance Characteristics	B <sub>MAX</sub>	—	Note 31	45	58	70	dB
	B <sub>MIN</sub>			-70	-58	-45	

## Video

Input Impedance	R <sub>i41</sub>	—	Note 32	100	—	—	k $\Omega$
Input Dynamic Range	V <sub>di41</sub>	—	Note 33	1.0	1.2	1.5	V
Video Total Gain	G <sub>Y</sub>	—	Note 34	4.5	5.0	—	
Video Frequency Characteristic	f <sub>Y</sub>	—	Note 35	6.0	7.0	—	MHz
Maximum Output	V <sub>do1</sub>	—	Note 36	7.5	8.0	—	V
Black Expansion Amp. Gain	G <sub>BAMP</sub>	—	Note 37	1.18	1.43	1.68	
Black Expansion Start Point	G <sub>BSTP</sub>			40	50	60	IRE
DC Restoration	T <sub>DC</sub>	—	Note 38	100	103	105	%
Sharpness Control Characteristics	G <sub>SHcent</sub>	—	Note 39	1	4	7	dB
	G <sub>SHmax</sub>			9	12	15	
	G <sub>SHmin</sub>			—	-18	-15	
Sharpness Delay Time	t <sub>SHDLY</sub>	—	Note 40	—	125	—	ns
Contrast Control Characteristics	G <sub>CNcent</sub>	—	Note 41	4.5	6	7.5	dB
	G <sub>CNmin</sub>	—		22.5	24	28.5	
H. V-BLK Output Voltage	V <sub>BLK</sub>	—	Note 42	—	0.7	1.0	V
V-BLK Width	T <sub>VBLK</sub>	—	Note 43	—	3.5~24	—	H
f <sub>sc</sub> Trap Gain	G <sub>TRAP</sub>	—	Note 44	—	-28	-20	dB

OSD

CHARACTERISTIC	SYMBOL	TEST CIRCUIT	TEST CONDITION	MIN.	TYP.	MAX.	UNIT
OSD Switching Voltage	$V_{thOSD}$	—	Note 45	0.7	1.0	1.3	V
OSD Delay Time	$t_{OSDDL Y}$	—	Note 46	—	15	30	ns
OSD Delay Time Difference	$t_{OSDD}$			—	5	10	
OSD Rising Time	$\tau_R$			—	15	30	
OSD Falling Time	$\tau_F$			—	15	30	
Input Clamp Voltage	$V_{OSDC}$			—	Note 47	4.4	
OSD Gain	$G_{OSD}$	—	Note 48	1.8	2.0	2.2	
Input Dynamic Range	$V_{diOSD}$		Note 49	2.0	2.2	2.4	V

Cutoff Drive

Brightness Control Characteristics	$V_{BRTmax}$	—	Note 50	3.6	4.0	4.3	V
	$V_{BRTcen}$			2.4	2.7	3.0	
	$V_{BRTmin}$			1.0	1.4	1.7	
Brightness Control Difference between 3Axes	$\Delta V_{RGB}$	—	Note 51	- 50	0	50	mV
Cutoff Control Characteristics	$V_{cutmax}$	—	Note 52	0.5	0.65	0.8	V
	$V_{cutcen}$			—	0.00	—	
	$V_{cutmin}$			- 0.8	- 0.65	- 0.5	
Drive Control Characteristics	$G_{drvmax}$	—	Note 53	3.75	4.25	4.75	dB
	$G_{drvmin}$			- 4.0	- 3.5	- 3.0	

Chroma

Input Dynamic Range	$V_{di45}$	—	Note 54	0.95	1.5	1.7	V
ACC Characteristic	ea	—	Note 55	- 23	- 20	- 17	dB
	eb			3	6	9	
	A			0.9	1.0	1.1	
Killer Point	EK	—	Note 56	- 48	- 46	- 43	dB
VCXO Frequency Control Range	$\Delta f_{VCXO}$	—	Note 57	$\pm 500$	$\pm 600$	—	Hz
VCXO Frequency Control Sensitivity	$\beta_{VCXO}$	—	Note 58	—	1.0	—	Hz / mV
VCXO Pull-in Range	$f_{VCXOPL}$	—	Note 59	$\pm 300$	$\pm 450$	—	Hz
Demodulate Relative Gain	R / B	—	Note 60	0.80	0.84	0.90	
	G / B			0.25	0.29	0.33	
Demodulate Relative Phase	R-B	—	Note 60	101	108	115	°
	G-B			236	243	250	
Carrier Wave Remain	E <sub>CR</sub>	—	Note 61	—	20	40	mV <sub>p-p</sub>
	E <sub>CB</sub>			—	20	40	
	E <sub>CG</sub>			—	20	40	

CHARACTERISTIC	SYMBOL	TEST CIR-CUIT	TEST CONDITION	MIN.	TYP.	MAX.	UNIT
Color Control Characteristic	$V_{CLRmax}$	—	Note 62	3.9	4.1	4.3	$V_{p-p}$
	$G_{CLRcen}$			4.5	6	7.5	dB
	$G_{CLRmin}$			38	40	—	
Uni-color Control Characteristic	$G_{UNIcen}$	—	Note 63	4.5	6	7.5	dB
	$G_{UNImin}$			22	24	26	
TINT Control Characteristic	$\theta_{TNTcen}$	—	Note 64	-7	0	7	°
	$\Delta\theta_{TNT}$			$\pm 35$	$\pm 45$	$\pm 55$	
Video Chroma Delay Time	$t_{V-C}$	—	Note 65	-30	0	30	ns

Deflection

Horizontal Free Run Freq.	$f_H$	—	Note 66	-100	0	100	Hz
H. Out Pulse Duty	$T_H$	—	Note 67	38	41	44	%
H. Out Voltage	$V_{HL}$	—	Note 68	—	0.2	0.3	V
	$V_{HH}$			2.5	3.0	3.5	
VCO Osc. Start Voltage	$V_{OSCmin}$	—	Note 69	3.0	3.5	4.0	V
H. Out Start Voltage	$V_{HST}$	—	Note 70	3.7	4.0	—	V
H. Frequency Control Range	$\Delta f_H$	—	Note 71	$\pm 500$	$\pm 650$	—	Hz
H. Freq. Control Sensitivity	$\beta_H$	—	Note 72	—	500	—	Hz / V
H. Sync. Pull-in Range	$\Delta f_{HPUL}$	—	Note 73	$\pm 450$	$\pm 500$	—	Hz
H. Pull-in Stop Period	$T_{HSTP}$	—	Note 74	—	259 ~272	—	H
AFC-2 Control Range	$T_{AFC2}$	—	Note 75	16	17	—	$\mu s$
Horizontal Position Adjustment	$T_{PAFC2}$	—	Note 76	—	$\pm 3$	—	$\mu s$
X-RAY Protection Detection Voltage	$V_{XDET}$	—	Note 77	3.35	3.5	3.65	V
X-RAY Protection Hold Voltage	$V_{XHLD}$			3.9	4.2	4.5	
X-RAY Protection Hold Current	$V_{XLD}$			80	100	120	$\mu A$
Vertical Free Run Freq.	$f_V$	—	Note 78	—	295	—	H
V. Sync. Pull-in Range	$T_{VST}$	—	Note 79	—	224	—	H
	$T_{VEND}$			—	295	—	
V. Out Pulse Width	$T_V$	—	Note 80	—	8	—	H
V. Ramp Amplitude Control	$V_{VL}$	—	Note 81	2.2	2.4	—	V
	$V_{VH}$			—	1.6	1.8	
H. Sync. Separation Level	$R_{sepa}$	—	Note 82	30	35	40	%
Forced V. Osc. (262.5H)	$f_{V60}$	—	Note 83	—	60	—	Hz

TEST CONDITION		TEST CONDITION (VCC = 9V, Ta = 25 ± 3°C)				MEASUREMENT METHOD
		BUS MODE				
NOTE	ITEM	(06)	(07)	(08)	(0A)	
1	Video Detected Output Level	(00)	(20)	(20)	---	<p>(1) Apply the IF signal. (f<sub>0</sub> = 45.75MHz, 87.5% AM, 31.6mVrms) to IF input.</p> <p>(2) Measure the output signal level at pin 47. (V<sub>O1</sub>)</p> <p>(3) Apply the signal (100% AM, 31.6mVrms) to IF input.</p> <p>(4) Measure the output signal level pin 47. (V<sub>O2</sub>)</p> 
2	Input Sensitivity	↑	↑	↑	↑	<p>(1) Apply the signal (f<sub>0</sub> = 45.75MHz, 30% AM, 31.6mVrms) to IF input.</p> <p>(2) Decrease input signal level. Measure the input signal level at IF input, when output signal level at pin 47 decreases as -3dB level. (V<sub>IN MIN</sub>)</p> <p>(3) Increase input signal level. Measure the input signal level at IF input, when output signal level at pin 47 increases as +0.5dB level. (V<sub>IN MAX</sub>)</p>
3	Sync. Tip Level	↑	↑	↑	↑	<p>(1) Apply the signal (f<sub>0</sub> = 45.75MHz, 31.6mVrms: Non modulation) to IF input.</p> <p>(2) Measure the DC voltage at pin 47 (V<sub>SYNC</sub>)</p>
4	Output Level for No Input	↑	↑	↑	↑	<p>(1) Non IF input</p> <p>(2) Apply 3.0V at pin 5.</p> <p>(3) Measure the DC voltage at pin 47. (V<sub>IF</sub>)</p>
5	Differential Gain Differential Phase	↑	↑	↑	↑	<p>(1) Apply the IF signal (f<sub>0</sub> = 45.75MHz, 87.5% AM Video) to IF input.</p> <p>(2) Measure the differential gain and phase at pin 47.</p>

TA1201AN-21

NOTE	ITEM	TEST CONDITION (V <sub>CC</sub> = 9V, T <sub>a</sub> = 25 ± 3°C)				MEASUREMENT METHOD
		BUS MODE				
		(06)	(07)	(08)	(0A)	
6	PIF Output Frequency Characteristics	(00)	(20)	(20)	—	(1) Same as Note 3 (1) (2) Fix the voltage at pin 5. (3) Apply the signal as follows to IF input, f <sub>0</sub> = 45.75MHz 31.6mV <sub>rms</sub> f <sub>1</sub> = 45.65~32MHz 3.16mV <sub>rms</sub> (4) Measure f <sub>1</sub> frequency, when the output level at pin 47 becomes -3dB. f <sub>c</sub> = f <sub>0</sub> - f <sub>1</sub>
7	Carrier Wave Compression Ratio 2nd Harmonics Compression Ratio	↑	↑	↑	↑	(1) Apply the signal (f <sub>0</sub> = 45.75MHz, f <sub>m</sub> = 15.75kHz, 78% AM, 31.6mV <sub>rms</sub> ) to IF input. (2) Apply the voltage at pin 5 so that output level of pin 47 becomes 2V <sub>p-p</sub> . (3) Measure the leak level of carrier wave at pin 47 when non modulation IF signal is inputted. CR = 20log (2 (V <sub>p-p</sub> )/the leak level of carrier wave (mV <sub>rms</sub> )) (4) Measure the leak level of 2nd harmonics in the same way. HR = 20log (2 (V <sub>p-p</sub> )/the leak level of 2nd harmonics (mV <sub>rms</sub> ))
8	PIF Input Resistance PIF Input Capacitance	↑	↑	↑	↑	(1) Apply 3.0V to pin 5. (2) Measure the impedance between pin 7 and 8.
9	S/N	↑	↑	↑	↑	(1) Same as Note 2 (1) (2) Measure output level at pin 47 (VA) (3) Same as Note 3 (1) (4) Measure output level at pin 47 (VB) S/N = 20log (VA / VB x 6)

TA1201AN-22

NOTE	ITEM	TEST CONDITION (V <sub>CC</sub> = 9V, Ta = 25 ± 3°C)				MEASUREMENT METHOD
		BUS MODE				
		(06)	(07)	(08)	(0A)	
10	920kHz Beat	(00)	(20)	(20)	---	(1) Apply the signals as follows to IF input, f <sub>0</sub> = 45.75MHz 31.6mV <sub>rms</sub> f <sub>c</sub> = 42.17MHz 10.0mV <sub>rms</sub> f <sub>S</sub> = 41.25MHz 10.0mV <sub>rms</sub> (2) Apply the voltage so that the lowest of the output at pin 47 is equal V <sub>sync</sub> .  (3) Measure the difference between f <sub>c</sub> and 920kHz beat.
11	IF AGC Range	↑	↑	↑	↑	RWAGC = V <sub>INMAX</sub> - V <sub>INMIN</sub>
12	IF AGC Voltage	↑	↑	↑	↑	(1) Same as Note 3 (1) (2) Measure the voltage at pin 5. (V <sub>5MEAN</sub> ) (3) Measure the voltage at pin 5 when no input. (V <sub>5MAX</sub> ) (4) Measure the voltage at pin 5 when input signal level is 178mV <sub>rms</sub> (V <sub>5MIN</sub> ).
13	RF AGC Voltage	↑	↑	Ad-just	↑	(1) Same as Note 3 (1) (2) Adjust the data of sub-address (08) (RF AGC) so that the voltage at pin 3 become 4.5V. (3) Measure the voltage at pin 3 when no input. (V <sub>3MAX</sub> ) (4) Measure the voltage at pin 3 when input signal level is 178mV <sub>rms</sub> (V <sub>3MIN</sub> ).

NOTE	ITEM	TEST CONDITION (V <sub>CC</sub> = 9V, T <sub>a</sub> = 25 ± 3°C)				MEASUREMENT METHOD
		BUS MODE				
		(06)	(07)	(08)	(0A)	
14	RF AGC Control Range	(00)	(20)	Ad-just	—	(1) Same as Note 3 (1) (2) Set the data of sub-address (08) to (00). Decrease the IF input level. Measure the IF input level, when the voltage of pin 3 become 4.5V. (V <sub>RFMIN</sub> ) (3) Set the data of sub-address (08) to (3F). Measure the IF input level, when the voltage of pin 3 become 4.5V. (V <sub>RFMAX</sub> ) $\Delta V_{RFAGC} = V_{RFMIN} - V_{RFMAX}$
15	AFT Center Voltage	↑	↑	(20)	↑	(1) No IF input (2) Apply 3.0V to pin 5. (3) Measure the voltage at pin 44. (V <sub>4CENT</sub> )
16	AFT Voltage	↑	↑	↑	↑	(1) Apply the signal (f = 44.75MHz, 30% AM Video, 31.6mV <sub>rms</sub> ) to IF input. (2) Measure the output signal level at pin 44. (V <sub>4MAX</sub> ) (3) Apply the signal (f = 46.75MHz, 30% AM Video, 31.6mV <sub>rms</sub> ) to IF input. (4) Measure the output signal level at pin 4. (V <sub>4MIN</sub> )
17	AFT Sensitivity	↑	↑	↑	↑	(1) Same as Note 3 (1) (2) Measure the voltage change at pin 44 when input frequency is changed. ( $\Delta f / \Delta v$ )
18	AFT Output Resistance	↑	↑	↑	↑	Measure the output impedance of pin 44.

TA1201AN-24



NOTE	ITEM	TEST CONDITION (V <sub>CC</sub> = 9V, T <sub>a</sub> = 25 ± 3°C)				MEASUREMENT METHOD
		BUS MODE				
		(06)	(07)	(08)	(0A)	
19	PIF VCO Control Sensitivity	(00)	(20)	(20)	—	(1) Apply the signal (f = 45.75MHz, 31.6mV <sub>rms</sub> , CW) to IF input. (2) Measure the DC voltage at pin 10. (V10A) (3) Apply the signal (f = 45.55MHz, 31.6mV <sub>rms</sub> , CW) to IF input. (4) Measure the DC voltage at pin 10. (V10B) $\beta FVCO = 0.2 \text{ (MHz)} / (V10B - V10A) \text{ (V)}$ [MHz/V]
20	PIF VCO Pull-in Range	↑	↑	↑	↑	(1) Apply the signal (f = 45.75MHz, 31.6mV <sub>rms</sub> , CW) to IF input. (2) Observe output signal at pin 47 and change the IF input frequency from higher to lower. Measure the IF input frequency when PLL is locked. Calculate the frequency difference between above frequency and 45.75MHz. (fph) (3) Observe output signal at pin 47 and change the IF input frequency from lower to higher. Measure the IF input frequency when PLL is locked. Calculate the frequency difference between above frequency and 45.75MHz. (fpl)
21	PIF VCO Control Range	↑	↑	Ad-just		(1) No IF input. (2) Apply 3.0V to pin 5. (3) Measure the frequency of PIF VCO when the data of sub-address (0A) is set (00) (f <sub>pifmin</sub> ) (4) Measure the frequency of PIF VCO when the data of sub-address (0A) is set (7F) (f <sub>pifmax</sub> )

NOTE	ITEM	TEST CONDITION (V <sub>CC</sub> = 9V, T <sub>a</sub> = 25 ± 3°C)							MEASUREMENT METHOD
		BUS MODE							
		(06)	(07)	(08)	(0A)	SW	52		
22	Sound Output Level	(00)	(20)	(20)	—	ON		(1) Apply the signal (f <sub>0</sub> = 4.5MHz, f <sub>m</sub> = 400Hz, 25kHz / devi FM, 100mV <sub>rms</sub> ) to pin 52. (2) Measure the output signal amplitude pin 54.	
23	Sound Distortion	↑	↑	↑	↑	↑		(1) Same as Note 22 (1) (2) Measure the distortion of output signal at pin 54.	
24	AMR	↑	↑	↑	↑	↑		(1) Apply the signals as follows to pin 52, FM : 400Hz 25kHz / devi FM, 100mV <sub>rms</sub> AM : 400Hz 30% 100mV <sub>rms</sub> (2) Measure the output level at pin 54 against each input. AMR = 20log (FM / AM)	
25	Limiting Sensitivity	↑	↑	↑	↑	↑		(1) Same as Note 22 (1) (2) Change the input level. Measure the input level when the output level at pin 54 become - 3dB.	
26	Sound Output Frequency Characteristics	↑	↑	↑	↑	↑		(1) Same as Note 22 (1) (2) Change the input frequency. Measure the input frequency when the output level at pin 54 become - 3dB compare with peak level.	
27	Sound Output Resistance	↑	↑	↑	↑	OFF		Measure the output impedance at pin 54.	

TA1201AN-25

NOTE	ITEM	TEST CONDITION (V <sub>CC</sub> = 9V, Ta = 25 ± 3°C)				MEASUREMENT METHOD
		BUS MODE				
		(02)	(06)	(07)	(08) (0A)	
28	ATT Gain	(80)	Ad-just	(20)	—	(1) Apply the signal (1kHz, 500mV <sub>rms</sub> ) to pin 55 and 56. (2) Set the data of sub-address (02) to (80) (3) Measure the output level at pin 1 and 2 when the data of sub-address (06) is set to (3F) (V <sub>ATTMAX</sub> ) GATTMAX = 20log (V <sub>ATTMAX</sub> / 500mV <sub>rms</sub> ) (4) Measure the output level at pin 1 and 2 when the data of sub-address (06) is set to (20) (V <sub>ATTMAX</sub> ) GATTMEAN = 20log (V <sub>ATTMEAN</sub> / V <sub>ATTMAX</sub> ) (5) Measure the output level at pin 1 and 2 when the data of sub-address (06) is set to (00) (V <sub>ATTMIN</sub> ) GATTMIN = 20log (V <sub>ATTMIN</sub> / V <sub>ATTMAX</sub> )
29	DC Voltage Drift	↑	↑	↑	↑	(1) Same as Note 28 (1) (2) Same as Note 28 (2) (3) Measure the DC voltage at pin 1 and 2. (V <sub>2DC</sub> ) (4) Measure the voltage change at pin 1 and 2 when the data of sub-address (06) is changed from (20) to (00). (V <sub>2VAR</sub> )
30	Input impedance	↑	(20)	↑	↑	Measure the input impedance of pin 53, 55 and 56.
31	Balance Characteristics	↑	↑	Ad-just	↑	(1) Same as Note 28 (1) (2) same as Note 28 (2) (3) Measure the output level difference between pin 1 and 2 when the data of sub-address (07) is set to (00) and (3F).

TA1201AN-27

NOTE	ITEM	TEST CONDITION (V <sub>CC</sub> = 9V, T <sub>a</sub> = 25 ± 3°C)									
		MEASUREMENT METHOD									
		BUS MODE									
		(00)	(02)	(03)	(04)	(0B)	(0C)	(0D)			
32	Input Impedance	(00)	(00)	(40)	(20)	(80)	(80)	(80)		Measure the input impedance of pin 37 and 39.	
33	Input Dynamic Range	↑	↑	↑	↑	↑	↑	↑		(1) TV Mode : Change the voltage in picture period at pin 37. External Mode : Change the voltage in picture period at pin 39. (2) Consider the change of R output as 100%. Measure the DC voltage at pin 19 when output level of pin 19 is 10% (V <sub>d11</sub> ). Measure the DC voltage at pin 41 when output level of pin 19 is 90% (V <sub>d12</sub> ). V <sub>d11</sub> = V <sub>d12</sub> - V <sub>d11</sub>	
34	Video Total Gain	↑	↑	(7F)	↑	↑	↑	↑		(1) TV Mode : Apply the input signal 1 (f <sub>0</sub> = 10kHz, 0.5V <sub>p-p</sub> ) External Mode : Apply the input signal 1 (f <sub>0</sub> = 10kHz, 0.5V <sub>p-p</sub> ) (2) Measure the sin signal amplitude at pin 19 (V <sub>g</sub> ) G-Y = 20log (V <sub>g</sub> / 0.5V <sub>p-p</sub> )	
35	Video Frequency Characteristics	↑	↑	(40)	↑	↑	↑	↑		Measure input frequency when the output level becomes -3dB.	
36	Maximum Output	↑	↑	(7F)	↑	↑	↑	↑		(1) Same as Note 33 (1) (2) Measure the maximum output level at pin 19.	

TA1201AN-28

NOTE	ITEM	TEST CONDITION (V <sub>CC</sub> = 9V, T <sub>a</sub> = 25 ± 3°C)									
		MEASUREMENT METHOD									
		BUS MODE									
		(00)	(02)	(03)	(04)	(0B)	(0C)	(0D)			
37	Black Expansion Amp. Gain Black Expansion Start Point	(00)	(00)	(40)	(20)	(80)	(80)	(80)	(80)		
			↑	Ad-just	↑	↑	↑	↑	↑		
38	DC Restoration		↑	Ad-just	↑	↑	↑	↑	↑		
39	Sharpness Control Characteristics		↑	(40) Ad-just	↑	↑	↑	↑	↑		

(1) Apply 1V<sub>p-p</sub> video signal as follows to video input.  
 (2) Measure the start point and amp gain of Black expansion at pin 19.

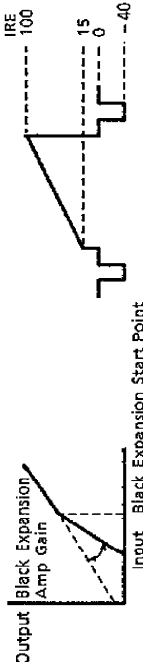

(1) TV Mode : Apply input signal 1 (f<sub>0</sub> = 10kHz 0.5V<sub>p-p</sub>) to pin 37.  
 External Mode : Apply input signal 1 (f<sub>0</sub> = 10kHz 0.5V<sub>p-p</sub>) to pin 39.  
 (2) Make pin 42 open. Adjust the data of sub-address (03) so that the output signal amplitude at pin 21 become 0.5V<sub>p-p</sub>.  
 (3) Measure the pedestal level at pin 21 when no luminance signal is inputted. (ΔY)  
 TCD = (Δy / 0.5V) × 100% [%]

(1) Apply input signal 1 (20mV<sub>p-p</sub>) to pin 39.  
 (2) Set the data of sub-address (04) is (3F)  
 (3) Measure the output signal amplitude at B out when the signal (f<sub>0</sub> = 10kHz) is applied (V<sub>10K</sub>) and when the signal (f<sub>0</sub> = 4MHz) is applied (V<sub>PK</sub>).  
 GSHMAX = 20log (V<sub>PK</sub> / V<sub>10K</sub>)  
 (4) Set the data of sub-address (04) is (00)  
 (5) Measure the output signal amplitude (V<sub>PK</sub>) at B output when the signal (f<sub>0</sub> = 2.4MHz) is applied.  
 GSHMIN = 20log (V<sub>PK</sub> / V<sub>10K</sub>)  
 (6) Set the data of sub-address (04) is (20)  
 (7) Measure the output signal amplitude (V<sub>PK</sub>) at B output when the signal (f<sub>0</sub> = 4.0MHz) is applied.  
 GSHCENT = 20log (V<sub>PK</sub> / V<sub>10K</sub>)

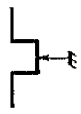
NOTE	ITEM	TEST CONDITION (V <sub>CC</sub> = 9V, T <sub>a</sub> = 25 ± 3°C)										MEASUREMENT METHOD	
		BUS MODE											
		(00)	(02)	(03)	(04)	(0B)	(0C)	(0D)					
40	Sharpness Delay Time	(00)	(00)	(40)	(3F)	(80)	(80)	(80)	(80)				Measure width of sharpness pulse.
41	Contrast Control Characteristic	↑	↑	Ad-just	(20)	↑	↑	↑	↑				(1) Apply input signal 1 (f <sub>0</sub> = 10kHz, 0.5V <sub>p-p</sub> ) to pin 39. (2) Set the data of sub-address (03) is (40). (3) Measure the output signal amplitude at pin 21. (V <sub>CNCENT</sub> ) (4) Measure the output signal amplitude at pin 21 when the data of sub-address (03) is set (7F) (V <sub>CNMAX</sub> ) (5) Measure the output signal amplitude at pin 21 when the data of sub-address (03) is set (00) (V <sub>CNMIN</sub> ) G <sub>CNMAX</sub> = 20log (V <sub>CNMAX</sub> / V <sub>CNCENT</sub> ) G <sub>CNMIN</sub> = 20log (V <sub>CNMIN</sub> / V <sub>CNMAX</sub> )
42	H.V-blanking Output Voltage	↑	↑	(40)	↑	↑	↑	↑	↑				Measure the blanking pulse voltage at pin 21. 
43	V-blanking Width	↑	↑	↑	↑	↑	↑	↑	↑				Measure the blanking pulse width at pin 21.
44	f <sub>sc</sub> Trap Gain	(80) ↓ (00)	↑	↑	↑	↑	↑	↑	↑				(1) Apply input signal 2. (f <sub>0</sub> = 3.58MHz, 0.5V <sub>p-p</sub> ) to pin 39. (2) Measure the output signal amplitude at B out when the data of sub-address (00) is set (80). (V <sub>TON</sub> ) (3) Measure the output signal amplitude at B out when the data of sub-address (00) is set (00). (V <sub>TOFF</sub> )

NOTE	ITEM	TEST CONDITION (V <sub>CC</sub> =9V, Ta=25±3°C)											
		BUS MODE											
		(00)	(02)	(03)	(04)	(0B)	(0C)	(0D)	MEASUREMENT METHOD				
45	OSD Switching Voltage	(00)	(00)	(40)	(20)	(80)	(80)	(80)	(80)	(80)	(80)	(1)	Apply the external voltage to pin 14. Increase the external voltage from 0V.
												(2)	Measure the voltage at pin 14 when the voltage of pin 19, 20 and 21 at picture period are changed.
46	OSD Delay Time OSD Delay Time Difference Among 3 Axis OSD Rising Time OSD Falling Time	↑	↑	↑	↑	↑	↑	↑	↑	↑	↑	(1)	Apply 1.5V to pin 14.
												(2)	Apply the signal as following fig. (a) to pin 15.
												(3)	Measure t <sub>R</sub> and t <sub>F</sub> of R output at pin 19 according fig. (b)
												(4)	Measure about G and B axis in the same way.
47	Input Clamp Voltage	↑	↑	↑	↑	↑	↑	↑	↑	↑	↑	(1)	Apply 1.5V to pin 14.
												(2)	Measure the voltage at pin 15, 16 and 17.

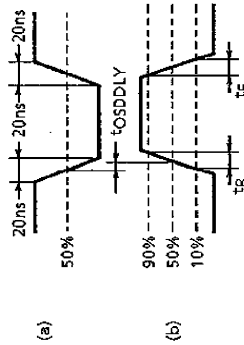

NOTE	ITEM	TEST CONDITION (V <sub>CC</sub> = 9V, T <sub>a</sub> = 25 ± 3°C)										
		BUS MODE										
		(00)	(02)	(03)	(04)	(0B)	(0C)	(0D)	MEASUREMENT METHOD			
48	OSD Gain	(00)	(00)	(40)	(20)	(80)	(80)	(80)	(80)	(80)	(80)	(1) Apply 1.5V to pin 14. (2) Apply the sine wave signal (10kHz, 0.5V <sub>p-p</sub> ) to pin 15, 16 and 17. (3) Measure the output signal of pin 19, 20 and 21. (V <sub>d1</sub> ) G-OSD = (V <sub>d1</sub> / 0.5V <sub>p-p</sub> )
49	Input Dynamic Range	↑	↑	↑	↑	↑	↑	↑	↑	↑	(1) Apply 1.5V to pin 14. (2) Apply the sine wave signal (10kHz) to pin 15, 16 and 17 with variable amplitude. (3) Consider the output change as 100%. Measure the input signal level when the output signal level is 10%, (V <sub>di1</sub> ) and when the output signal level is 90%. (V <sub>di2</sub> ) V <sub>diOSD</sub> = V <sub>di2</sub> - V <sub>di1</sub>	



NOTE	ITEM	TEST CONDITION (V <sub>CC</sub> = 9V, T <sub>a</sub> = 25 ± 3°C)							MEASUREMENT METHOD			
		BUS MODE										
		(00)	(02)	(03)	(0B)	(80)	(0C)	(0D)		(0E)	(0F)	
50	Brightness Control Characteristics	(00)	Ad-just	(40)	(80)	(80)	(80)	(00)	(00)	(00)	(00)	(1) Apply a color bar signal to pin 39. (2) Measure the pedestal level of RGB output signal at pin 19, 20 and 21 when the data of sub-address (02) is set (7F). (V <sub>BRTmax</sub> ) (3) Measure the pedestal level of RGB output signal at pin 19, 20 and 21 when the data of sub-address (02) is set (40). (V <sub>BRTcest</sub> ) (4) Measure the pedestal level of RGB output signal at pin 19, 20 and 21 when the data of sub-address (02) is set (00). (V <sub>BRTmin</sub> )
51	Brightness Control Difference between 3 Axis.	↑	(40)	↑	↑	↑	↑	↑	↑	↑	(1) Apply a color bar signal to pin 39. (2) Measure the different of pedestal voltage among 3 axis at pin 19, 20 and 21.	
52	Cut off Characteristics	↑	↑	↑	Ad-just	Ad-just	Ad-just	Ad-just	Ad-just	Ad-just	(1) Apply a color bar signal to pin 39. (2) Measure the pedestal level of RGB output signal at pin 19, 20 and 21 when the data of sub-address (0B, 0C, 0D) is set (FF) (V <sub>CUTMAX'</sub> ) V <sub>CUTMAX</sub> = V <sub>CUTMAX'</sub> - V <sub>BRTcen</sub> (3) Measure the pedestal level of RGB output signal at pin 19, 20 and 21 when the data of sub-address (0B, 0C, 0D) is set (80) (V <sub>CUTCEN'</sub> ) V <sub>CUTCEN</sub> = V <sub>CUTCEN'</sub> - V <sub>BRTcen</sub> (4) Measure the pedestal level of RGB output signal at pin 19, 20 and 21 when the data of sub-address (0B, 0C, 0D) is set (00) (V <sub>CUTMIN'</sub> ) V <sub>CUTMIN</sub> = V <sub>CUTMIN'</sub> - V <sub>BRTcen</sub>	

TA1201AN-33

NOTE	ITEM	TEST CONDITION (V <sub>CC</sub> =9V, Ta=25±3°C)							MEASUREMENT METHOD		
		BUS MODE									
		(00)	(02)	(03)	(0B)	(0C)	(0D)	(0E)		(0F)	
53	Drive Control Characteristics	(40)	(00)	(40)	(80)	(80)	(80)	(80)	Ad-just just	Ad-just just	(1) Apply the input signal 1 (f <sub>0</sub> = 10kHz, 0.5V <sub>p-p</sub> ) to pin 39. (2) Measure the voltage of G and B output signal at picture period at pin 20 and 21 when the data of sub-address (0E, 0F) is set (80) (V <sub>drvcen</sub> ) (3) Measure the voltage of G and B output signal at picture period at pin 20 and 21 when the data of sub-address (0E, 0F) is set (FF) (V <sub>drvmax</sub> ) G <sub>drvmax</sub> = 20log (V <sub>drvmax</sub> / V <sub>drvcen</sub> ) (4) Measure the voltage of G and B output signal at picture period at pin 20 and 21 when the data of sub-address (0E, 0F) is set (00) (V <sub>drvmin</sub> ) G <sub>drvmin</sub> = 20log (V <sub>drvmin</sub> / V <sub>drvcen</sub> )

NOTE	ITEM	TEST CONDITION (V <sub>CC</sub> = 9V, Ta = 25 ± 3°C)										
		BUS MODE										
		(00)	(01)	(02)	(03)	(0E)	(0F)					
54	Input Dynamic Range	(40)	(40)	(00)	(40)	(80)	(80)					MEASUREMENT METHOD  (1) Change the voltage of external input signal at picture period at pin 39. (2) Consider the output change at pin 21 as 100%. Measure the output signal amplitude at pin 21 when the output signal is 10% (V <sub>d11</sub> ) and when the output signal is 90% (V <sub>d12</sub> ). V <sub>d145</sub> = V <sub>d12</sub> - V <sub>d11</sub>
55	ACC Characteristic	↑	↑	↑	↑	↑	↑	↑	↑	↑	↑	(1) Apply a rainbow color bar signal to pin 39. (2) Measure the RGB output signal as F <sub>1</sub> and F <sub>3</sub> at pin 19, 20 and 21 when the input signal level is 100mV <sub>p-p</sub> and 300mV <sub>p-p</sub> . A = F <sub>1</sub> / F <sub>3</sub>
56	Killer Point	↑	↑	↑	↑	↑	↑	↑	↑	↑	↑	Apply the burst signal (50mV <sub>p-p</sub> ) to pin 39. Decrease the input level by using ATT. Measure the input burst signal when color killer on.
57	VCXO Frequency Control Range	↑	↑	↑	↑	↑	↑	↑	↑	↑	↑	(1) Measure the DC voltage at pin 11. (V <sub>11</sub> ) (2) Measure the frequency change at pin 12 when the voltage of pin 11 is change from V <sub>11</sub> - 0.5V to V <sub>11</sub> + 0.5V.
58	VCXO Frequency Control Sensitivity	↑	↑	↑	↑	↑	↑	↑	↑	↑	↑	(1) Same as Note 57 (1) (2) Same as Note 57 (2) (3) Measure the sensitivity against 1mV at pin 11.

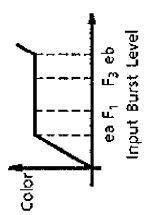

TA1201AN-35

NOTE	ITEM	TEST CONDITION (V <sub>CC</sub> = 9V, T <sub>a</sub> = 25 ± 3°C)							MEASUREMENT METHOD
		BUS MODE							
		(00)	(01)	(02)	(03)	(0E)	(0F)		
59	VCXO Pull-in Range	(40)	(40)	(00)	(40)	(80)	(80)		(1) Apply a rainbow color bar signal to pin 39. (2) Observe the RGB output signal at pin 19, 20 and 21. Change input f <sub>sc</sub> frequency by 10Hz step up to ±3kHz. Measure the pull-in range.
60	Demodulate Relative Gain Demodulate Relative Phase	↑	↑	↑	↑	↑	↑		(1) Apply the rainbow color bar signal (f <sub>sc</sub> = 3.479545MHz, 0.3V <sub>p-p</sub> ) to pin 39. (2) Measure the amplitude and phase of 100Hz signal at pin 19, 20 and 21. Calculate R/B, G/B, R-B, G-B.
61	Carrier Wave Remain	↑	Ad-just	↑	↑	↑	↑		(1) Apply a rainbow color bar signal to pin 39. (2) Adjust the data of sub-address (01) so that the RGB output amplitude at pin 19, 20 and 21 will be maximum. (3) Apply the signal that has only sync. and burst signal to pin 39. (4) Measure the f <sub>sc</sub> components of RGB output signal at pin 19, 20 and 21.
62	Color Control Characteristic	Ad-just	(40)	↑	↑	↑	↑		(1) Apply a rainbow color bar signal to pin 39. (2) Measure the amplitude of RGB output signal at pin 19, 20 and 21 when the data of sub-address (00) is set (7F). (V <sub>CLRmax</sub> ) (3) Measure the amplitude of RGB output signal at pin 19, 20 and 21 when the data of sub-address (00) is set (40). (V <sub>CLRcen</sub> ) G <sub>CLRcen</sub> = 20log (V <sub>CLRmax</sub> / V <sub>CLRcen</sub> ) (4) Measure the amplitude of RGB output signal at pin 19, 20 and 21 when the data of sub-address (00) is set (00). (V <sub>CLRmin</sub> ) G <sub>CLRmin</sub> = 20log (V <sub>CLRmax</sub> / V <sub>CLRmin</sub> )

TA1201AN-36

NOTE	ITEM	TEST CONDITION (V <sub>CC</sub> = 9V, T <sub>a</sub> = 25 ± 3°C)						MEASUREMENT METHOD
		BUS MODE						
		(00)	(01)	(02)	(03)	(0E)	(0F)	
63	Uni-color Control Characteristic	(40)	(40)	(00)	Ad-just	(80)	(80)	(1) Apply a rainbow color bar signal to pin 39. (2) Measure the amplitude of RGB output signal at pin 19, 20 and 21 when the data of sub-address (03) is set (7F). (V <sub>UNImax</sub> ) (3) Measure the amplitude of RGB output signal at pin 19, 20 and 21 when the data of sub-address (03) is set (40). (V <sub>UNIcen</sub> ) G <sub>UNIcen</sub> = 20%og (V <sub>UNImax</sub> / V <sub>UNIcen</sub> ) (4) Measure the amplitude of RGB output signal at pin 19, 20 and 21 when the data of sub-address (03) is set (00). (V <sub>UNImin</sub> ) G <sub>UNImin</sub> = 20%og (V <sub>UNImax</sub> / V <sub>UNImin</sub> )
64	TINT Control Characteristic	↑	Ad-just	↑	(40)	↑	↑	(1) Apply a rainbow color bar signal to pin 39. (2) Adjust the data of sub-address (01) so that the 6th bar of B output signal at pin 21. (θ <sub>TNTcen</sub> ) (3) Measure phase change of B output signal at pin 21 when the data of sub-address (01) is change from (00) to (7F). (Δθ <sub>TNT</sub> )
65	Video Chroma Delay Time	(40)	↓	(40)	↑	↑	↑	(1) Apply a rainbow color bar signal to pin 39. (2) Measure rising time of color signal at pin 19, 20 and 21. When the data of sub-address (04) is set (60). (DTC) (3) Measure rising time of Y signal at pin 19, 20 and 21 when the data of sub-address (04) is set (00). (DTY) tv-C = DTY - DTC

NOTE	ITEM	TEST CONDITION (V <sub>CC</sub> = 9V, Ta = 25 ± 3°C)			MEASUREMENT METHOD
		BUS MODE			
		(05)	(09)	(0A)	
66	Horizontal Free Run Frequency	(10)	(20)	(40)	Measure the frequency of H-out at pin 32. (f <sub>H'</sub> ) f <sub>H</sub> = f <sub>H'</sub> - 15.734kHz
67	Horizontal Out Pulse Duty	↑	↑	↑	Measure the duty of horizontal pulse at pin 32.
68	Horizontal Out Voltage	↑	↑	↑	Measure the high level and low level at pin 32. 
69	VCO Oscillation Start Voltage	↑	↑	↑	Increase H. V <sub>CC</sub> from 0V at pin 26. Measure the H. V <sub>CC</sub> at pin 26 when VCO starts oscillation.
70	Horizontal Output Start Voltage	↑	↑	↑	Increase H. V <sub>CC</sub> from 0V at pin 26. Measure the H. V <sub>CC</sub> at pin 26 when Horizontal pulse starts to output at pin 32.
71	Horizontal Frequency Control Range	↑	↑	↑	(1) Measure the DC voltage at pin 33. (2) Measure Horizontal frequency control range when the voltage of pin 33 is changed from V <sub>33</sub> - 0.5V to V <sub>33</sub> + 0.5V.
72	Horizontal Frequency Control Sensitivity	↑	↑	↑	(1) Same as Note 71 (1) (2) Same as Note 71 (2) (3) Measure horizontal frequency control sensitivity against 1mV at pin 33.

TA1201AN-38

NOTE	ITEM	TEST CONDITION (V <sub>CC</sub> = 9V, T <sub>a</sub> = 25 ± 3°C)			MEASUREMENT METHOD
		BUS MODE			
		(05) (09)	(0A) SW <sub>30</sub>		
73	Horizontal Sync. Pull-in Range	(10) (20)	(40) OFF		(1) Apply Sync. signal to pin 39. (2) Observe horizontal output at pin 32. Change the input sync. frequency by 10Hz. Step up to ±3kHz. Measure the pull-in range.
74	Horizontal Sync. Pull-in Stop Period	↑	↑	↑	(1) Apply Sync. signal to pin 39. (2) Observe input sync. signal and pin 33. Measure the pull-in stop period as follows.
75	AFC-2 Control Range	↑	ON ↓ OFF	↑	(1) SW <sub>30</sub> is on, and delay the rising of FBP from rising of horizontal out by 1μs step. (2) SW <sub>30</sub> is off. Measure the maximum delay time which AFC2 can pull-in.
76	Horizontal Sync. Position Adjustment	↑	OFF	↑	(1) Measure the phase of horizontal out when the data of sub-address (05) is set (10). (2) Measure phase change when the data of sub-address (05) is change to (00) and (1F).

TA1201AN-39

NOTE	ITEM	TEST CONDITION (V <sub>CC</sub> = 9V, Ta = 25 ± 3°C)			MEASUREMENT METHOD
		(05)	(09)	(0A)	
77	X-RAY Protection detect Voltage X-RAY Protection Hold Voltage X-RAY Protection Hold Current	(10)	(20)	(40)	<p>(1) Connect external voltage supply to pin 29. (2) Measure each point as follows. XLD = (V<sub>29OFF</sub> - V<sub>XOFF</sub>) / 10kΩ</p>
78	Vertical Free Run Frequency	↑	↑	↑	<p>Measure vertical frequency at pin 22. (f<sub>V</sub>) f<sub>V</sub> = f<sub>V'</sub> / 15.734kHz</p>
79	Vertical Sync. Pull-in Range	↑	↑	↑	<p>(1) Apply sync. signal to pin 39. (2) Observe vertical output at pin 22. Change input frequency by 0.5H step. Measure vertical sync. pull-in range.</p>
80	Vertical Pulse Width	↑	↑	↑	<p>Measure vertical pulse width as follows.</p>

TA1201AN-40

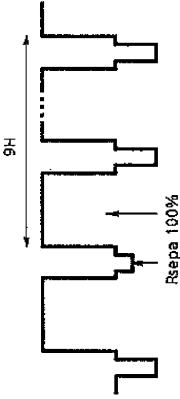

NOTE	ITEM	TEST CONDITION (V <sub>CC</sub> = 9V, T <sub>a</sub> = 25 ± 3°C)			MEASUREMENT METHOD
		BUS MODE			
		(05) (09)	(0A)		
81	Vertical Ramp Amplitude Control	(10)	Ad-just	(40)	<p>(1) Measure vertical ramp amplitude when the data of sub-address (09) is set (3F). (V<sub>VH</sub>)</p> <p>(2) Measure vertical ramp amplitude when the data of sub-address (09) is set (00). (V<sub>VL</sub>)</p>
82	Horizontal Sync. Separation Level	↑	(20)	↑	<p>(1) Apply white 100% signal that has short sync. every 10H to pin 39.</p> <p>(2) Observe sync. separation output at pin 31. Measure sync. separation level by changing sync. length.</p> 
83	Forced V. Osc. (262.5H)	↑	↑	(C0)	<p>(1) Set the data of sub-address (0A) to (C0).</p> <p>(2) Measure vertical frequency at pin 22.</p>

TA1201AN-41

SIGNAL FOR MEASUREMENT

① Input Signal 1

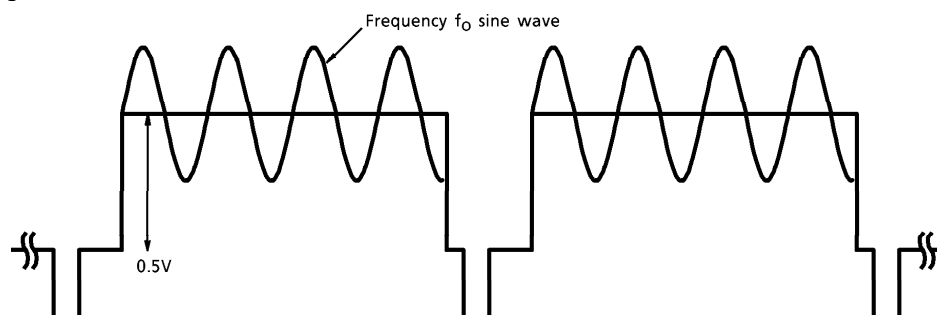

② Input Signal 2

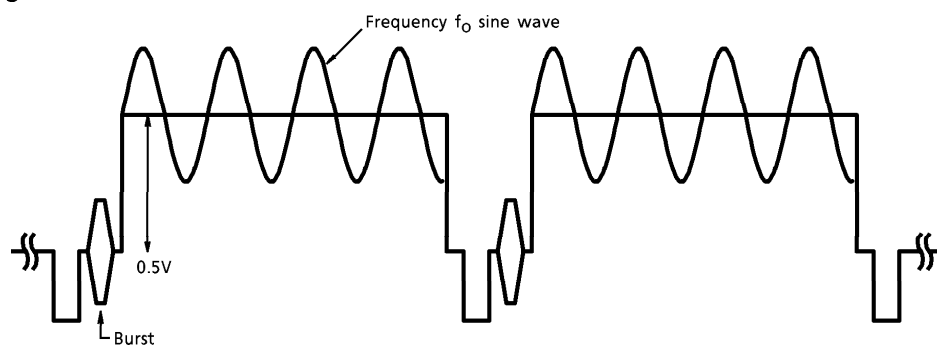



OUTLINE DRAWING  
SDIP56-P-600-1.78

Unit : mm

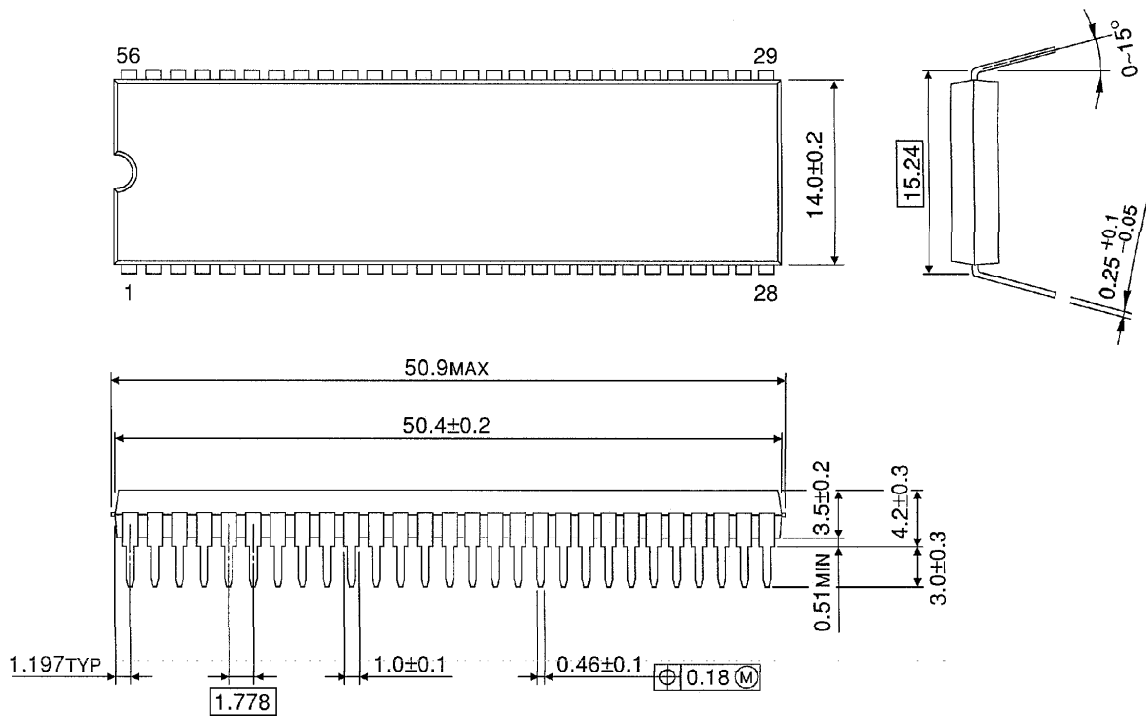

Weight : 5.55g (Typ.)