

| V _{RSM} | V _{RRM} V _{DRM} | (dv/dt) _{cr} | I _{TRMS} (maximum values for continuous operation) | |
|------------------|--------------------------------------|-----------------------|--|---------------------|
| | | | 600 A | 700 A |
| V | V | V/μs | I _{TAV} (sin. 180; T _{case} = . . . ; DSC) | |
| | | | 380 A (60 °C) | 450 A (57 °C) |
| 500 | 400 | 500 | SKT 240/04 D | SKT 340/04 D |
| 900 | 800 | 1000 | SKT 240/08 E | SKT 340/08 E |
| 1300 | 1200 | 1000 | SKT 240/12 E | SKT 340/12 E |
| 1500 | 1400 | 1000 | SKT 240/14 E | SKT 340/14 E |
| 1700 | 1600 | 1000 | SKT 240/16 E | SKT 340/16 E |
| 1900 | 1800 | 1000 | SKT 240/18 E | SKT 340/18 E |
| 2100 | 2000 | 1000 | SKT 240/20 E | - |
| 2300 | 2200 | 1000 | SKT 240/22 E | - |

Thyristors

**SKT 240
SKT 340**



| Symbol | Conditions | SKT 240 | SKT 340 | Units |
|-----------------------------------|--|----------------|-------------|------------------|
| I _{TAV} | sin. 180; (T _{case} = . . .); DSC | 240 (92) | 340 (82) | A °C |
| I _{TSM} | T _{vj} = 25 °C; 10 ms | 5 000 | 5 700 | A |
| i ² t | T _{vj} = 125 °C; 10 ms | 4 500 | 5 200 | A |
| | T _{vj} = 25 °C; 8,3 ... 10 ms | 125 000 | 162 000 | A ² s |
| | T _{vj} = 125 °C; 8,3 ... 10 ms | 101 000 | 135 000 | A ² s |
| t _{gd} | T _{vj} = 25 °C I _G = 1 A di _G /dt = 1 A/μs | typ. 1 | | μs |
| t _{gr} | V _D = 0,67 · V _{DRM} | typ. 2 | | μs |
| (di/dt) _{cr} | f = 50 ... 60 Hz | 125 | | A/μs |
| I _H | T _{vj} = 25 °C; typ./max. | 150 / 400 | | mA |
| I _L | T _{vj} = 25 °C; typ./max. | 0,3 / 1 | | A |
| t _q | T _{vj} = 125 °C; typ. | 50 ... 150 | | μs |
| V _T | T _{vj} = 25 °C; I _T = 1000 A; max. | 2,3 | 1,9 | V |
| V _{T(TO)} | T _{vj} = 125 °C | 1,0 | 1,0 | V |
| r _T | T _{vj} = 125 °C | 1,4 | 0,9 | mΩ |
| I _{DD} ; I _{RD} | T _{vj} = 125 °C; V _{RD} = V _{RRM} V _{DD} = V _{DRM} | 40 | 40 | mA |
| V _{GT} | T _{vj} = 25 °C | 2 | | V |
| I _{GT} | T _{vj} = 25 °C | 150 | | mA |
| V _{GD} | T _{vj} = 125 °C | 0,25 | | V |
| I _{GD} | T _{vj} = 125 °C | 10 | | mA |
| R _{thjc} | cont.; DSC | 0,070 | | °C/W |
| | sin. 180; DSC/SSC | 0,072 / 0,151 | | °C/W |
| | rec. 120; DSC/SSC | 0,080 / 0,168 | | °C/W |
| R _{thch} | DSC/SSC | 0,020 / 0,040 | | °C/W |
| T _{vj} | | - 40 ... + 125 | | °C |
| T _{stg} | | - 40 ... + 130 | | °C |
| F | SI units | 4 ... 5 | | kN |
| | US units | 900 ... 1100 | | lbs. |
| w | | 61 | | g |
| Case | → page B 3 – 32 | B 8 | | |

Features

- Hermetic metal cases with ceramic insulators
- Capsule packages for double sided cooling
- Shallow design with single sided cooling
- International standard cases
- Off-state and reverse voltages up to 1800 V

Typical Applications

- DC motor control (e. g. for machine tools)
- Controlled rectifiers (e. g. for battery charging)
- AC controllers (e. g. for temperature control)

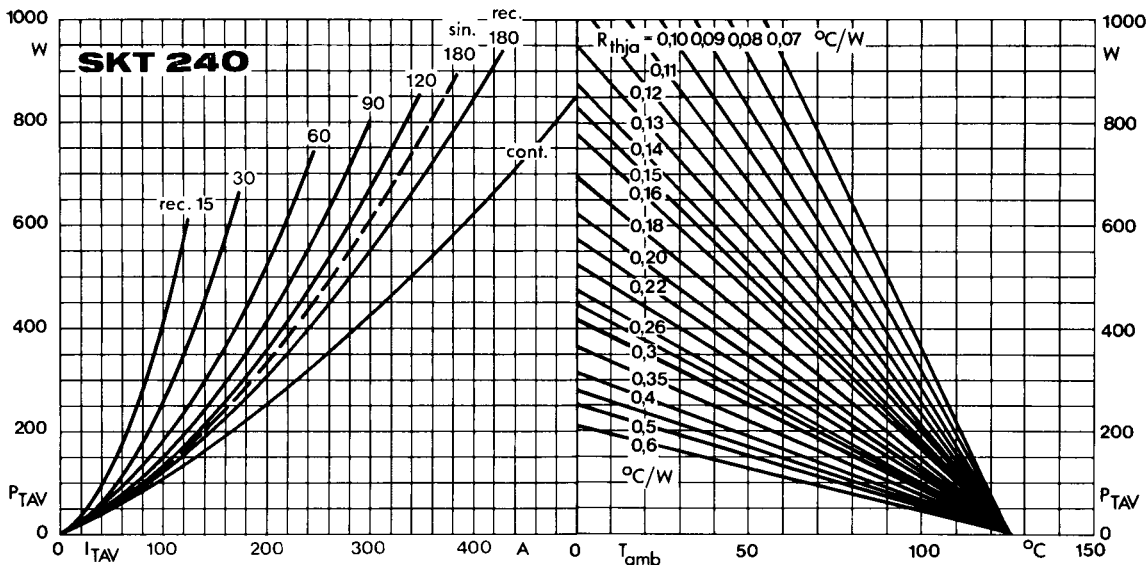

Fig. 1 a Power dissipation vs. on-state current and ambient temperature

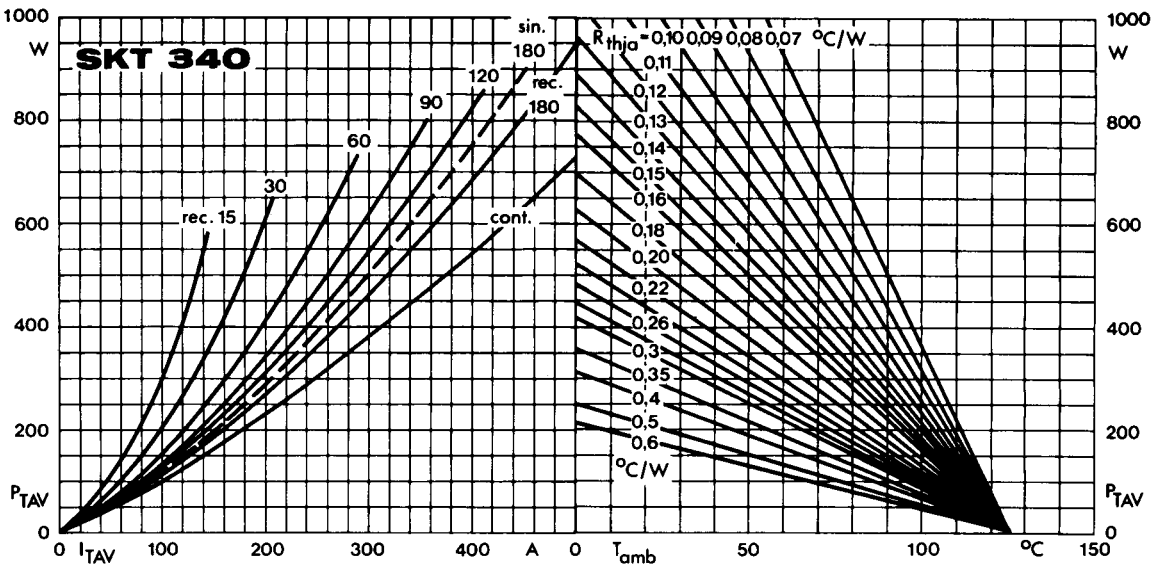

Fig. 1 b Power dissipation vs. on-state current and ambient temperature

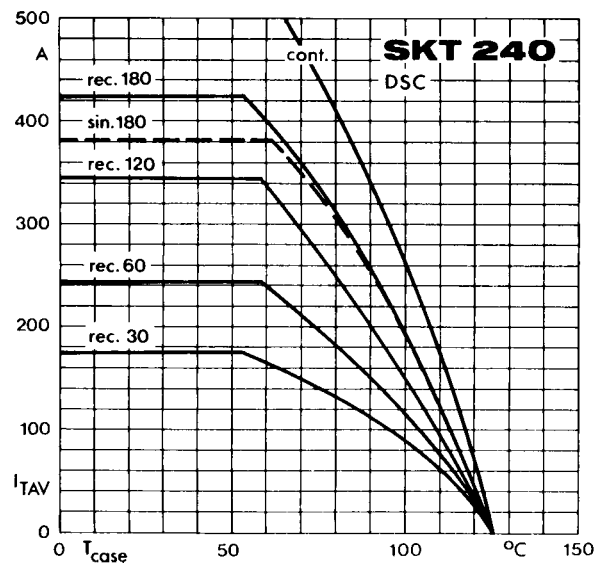

Fig. 2 a Rated on-state current vs. case temperature

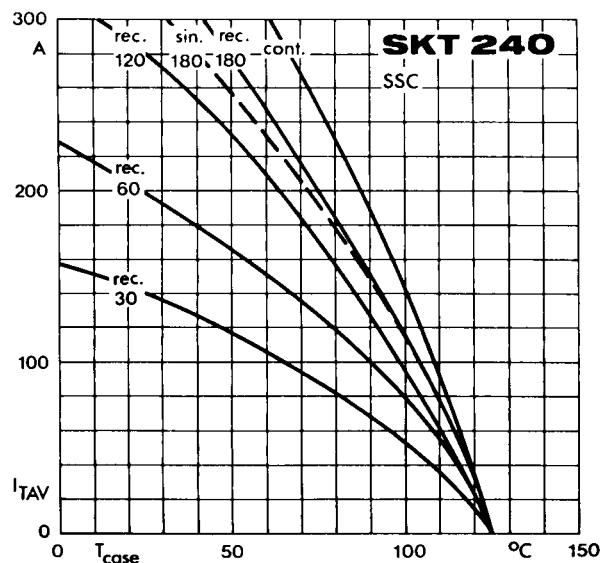

Fig. 2 b Rated on-state current vs. case temperature

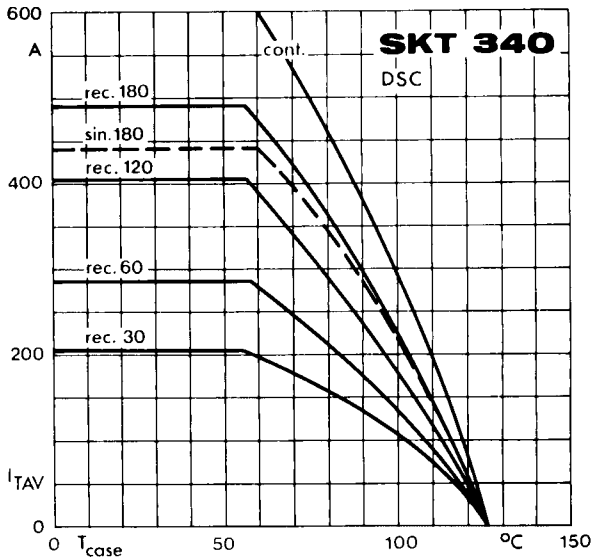

Fig. 2 c Rated on-state current vs. case temperature

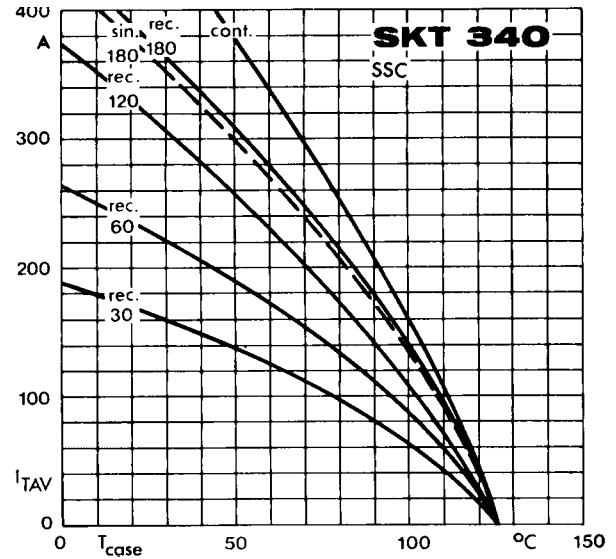

Fig. 2 d Rated on-state current vs. case temperature

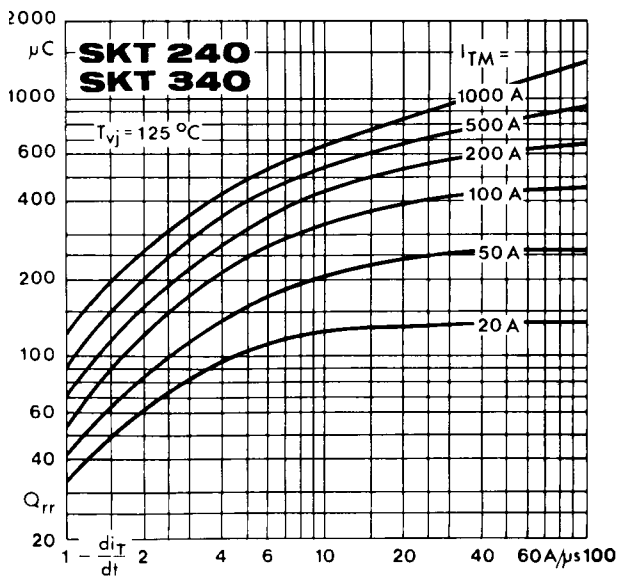

Fig. 3 Recovered charge vs. current decrease

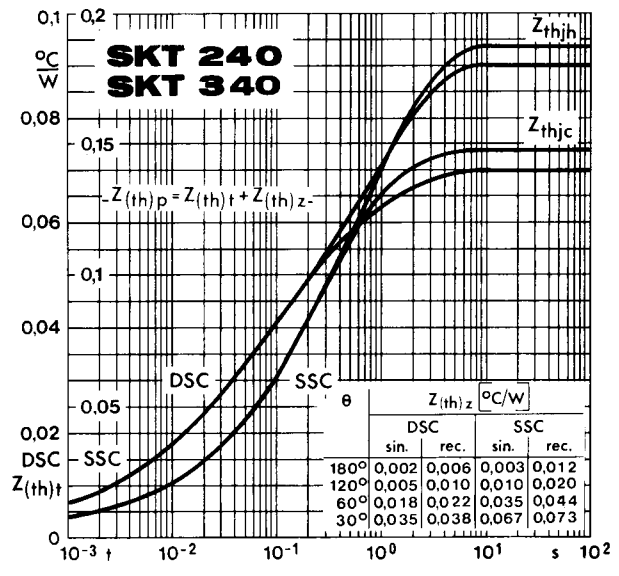

Fig. 4 Transient thermal impedance vs. time

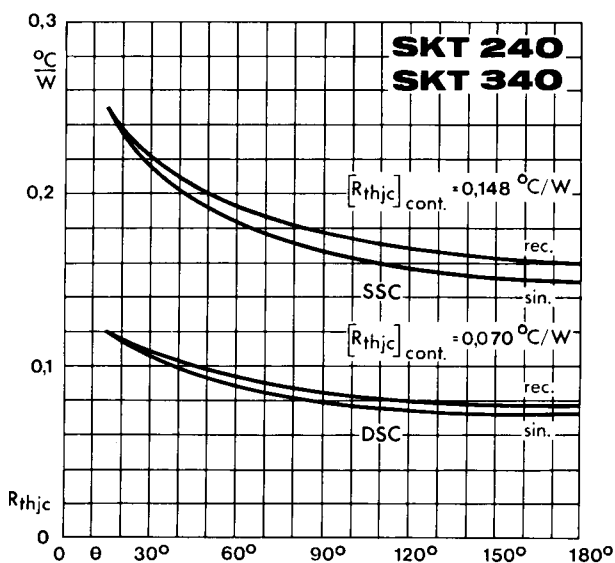

Fig. 5 Thermal resistance vs. conduction angle

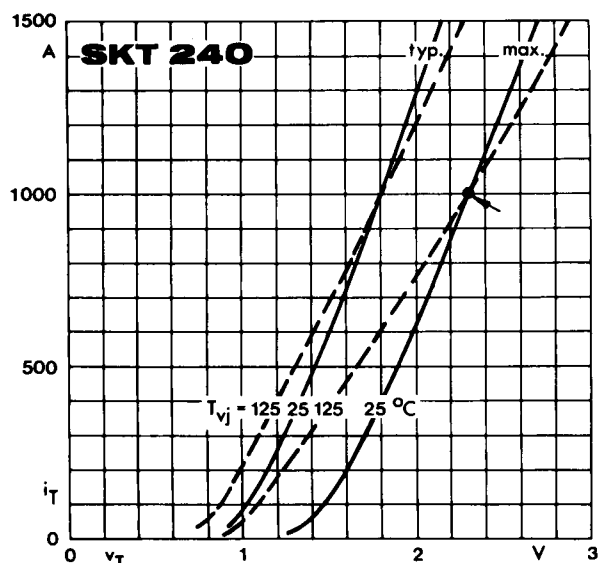

Fig. 6 a On-state characteristics

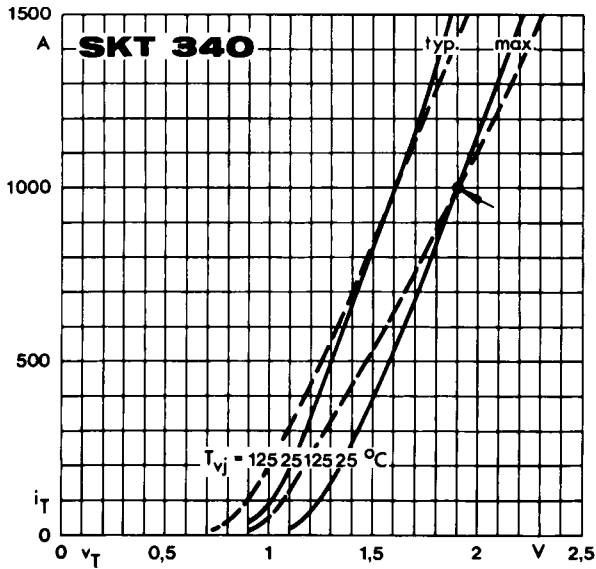

Fig. 6 b On-state characteristics

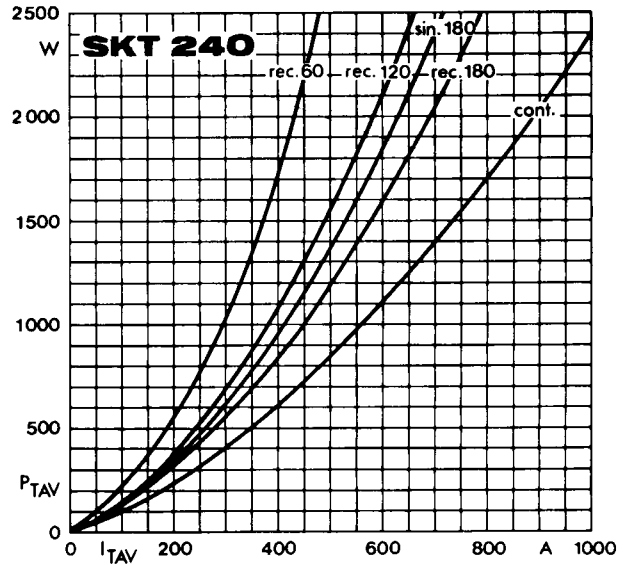

Fig. 7 a Power dissipation vs. on-state current

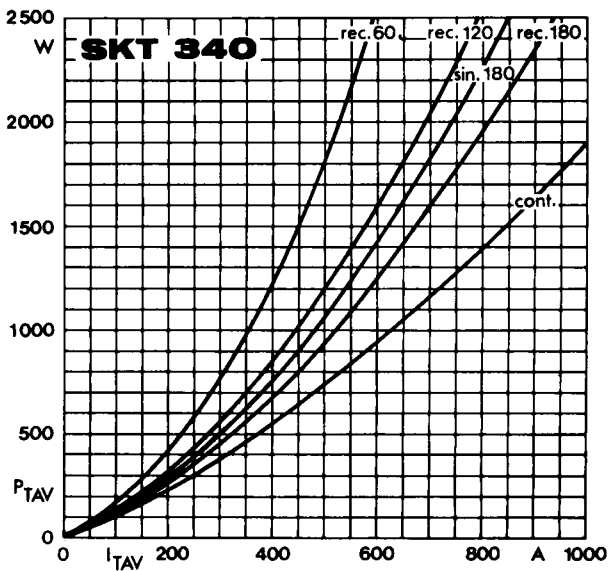

Fig. 7 b Power dissipation vs. on-state current

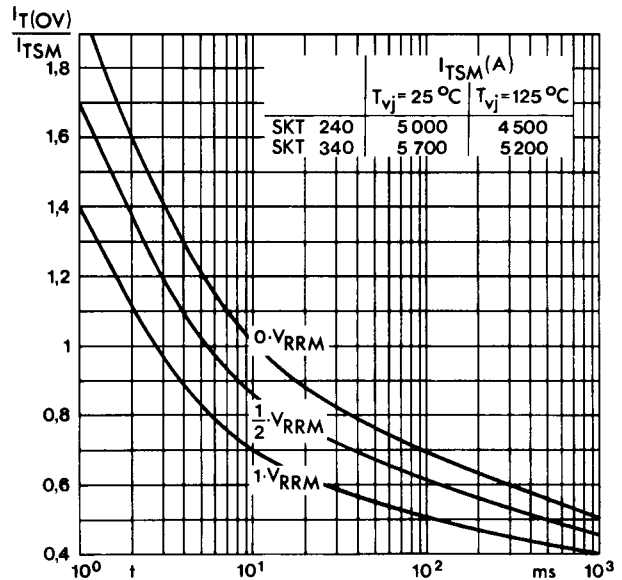

Fig. 8 Surge overload current vs. time

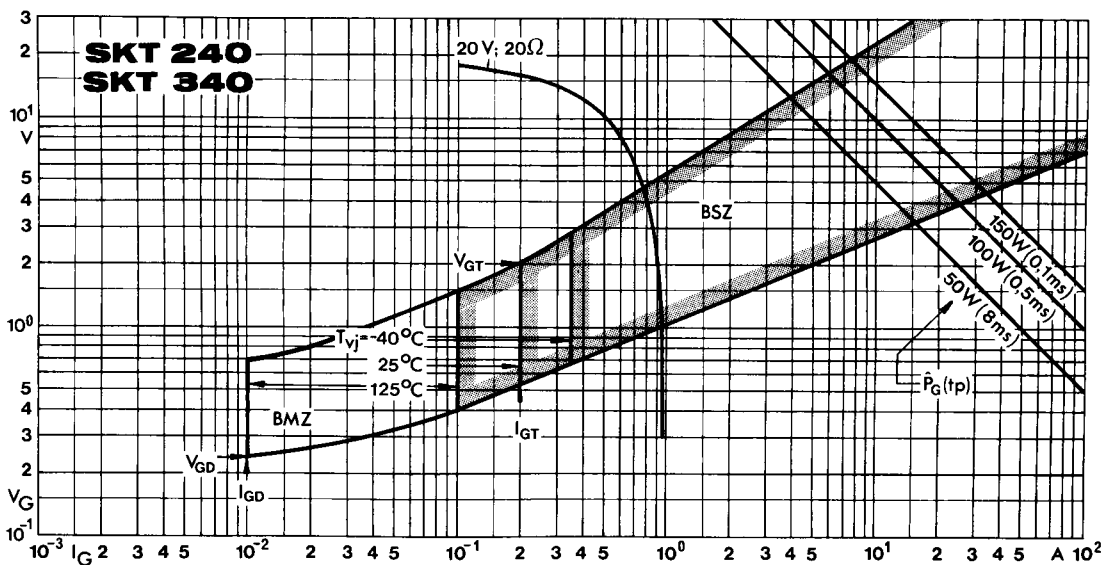
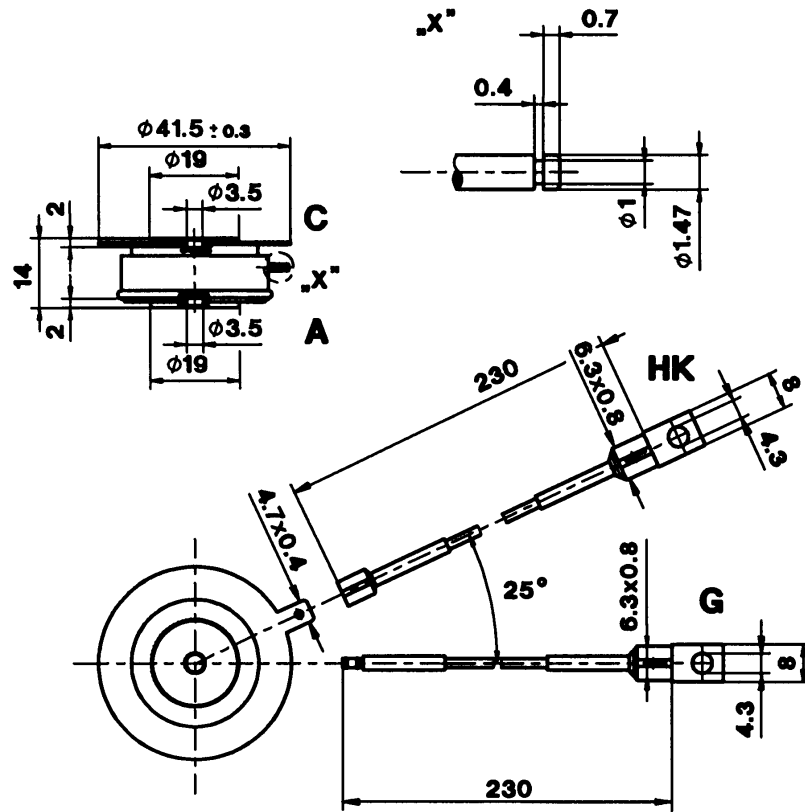

Fig. 9 Gate trigger characteristics

SKT 240
SKT 340

Case B 8

DIN 41814: 151 A 4
JEDEC: TO-200 AB



SKT 491
SKT 551

Case B 11

DIN 41814: 152 A 4
JEDEC: TO-200 AB

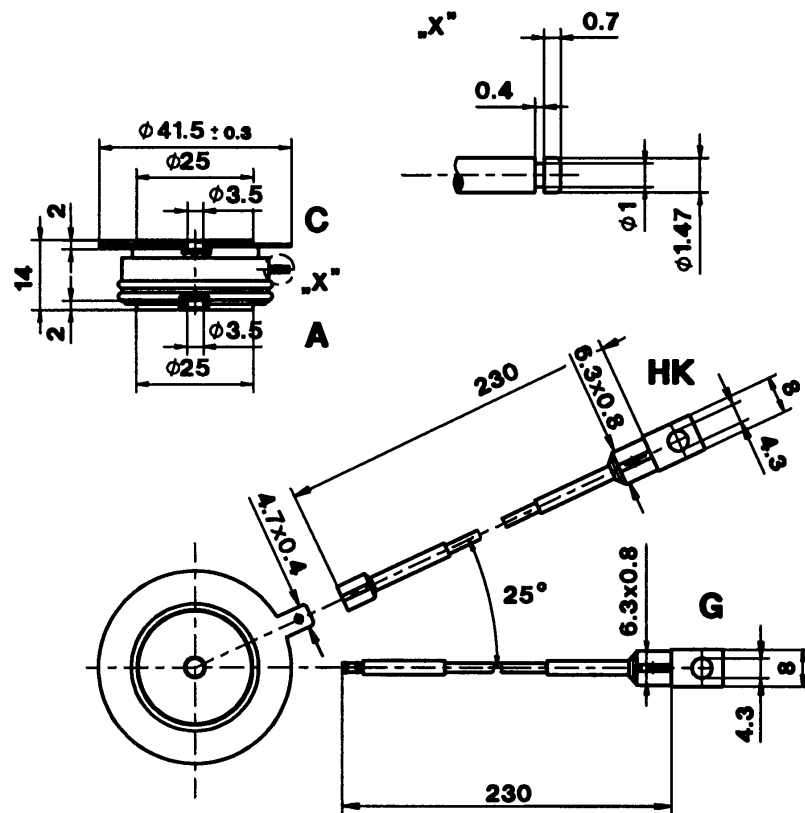

- C: Cathode terminal (red sleeve)
- A: Anode terminal
- G: Gate terminal (yellow sleeve)
- HK: Auxiliary cathode terminal (red sleeve)

Dimensions in mm