

# NCS2510

## 1.4 GHz Current Feedback Op Amp

NCS2510 is a 1.4 GHz current feedback monolithic operational amplifier featuring high slew rate and low differential gain and phase error. The current feedback architecture allows for a superior bandwidth and low power consumption.

### Features

- -3.0 dB Small Signal BW ( $A_V = +2.0$ ,  $V_O = 0.5 V_{p-p}$ ) 1.4 GHz Typ
- Slew Rate 2500 V/ $\mu$ s
- Supply Current 12 mA
- Input Referred Voltage Noise 5.0 nV/ $\sqrt{\text{Hz}}$
- THD -69 dB ( $f = 5.0$  MHz,  $V_O = 2.0 V_{p-p}$ )
- Output Current 120 mA
- Pin Compatible with AD8001, TSH330, OPA658
- This is a Pb-Free Device

### Applications

- High Resolution Video
- Line Driver
- High-Speed Instrumentation
- Wide Dynamic Range IF Amp
- Set Top Box
- NTSC/PAL/HDTV

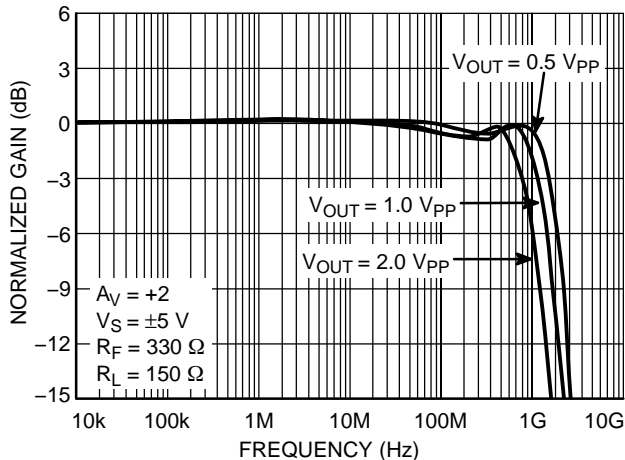

**Figure 1. Frequency Response:**  
Gain (dB) vs. Frequency  
 $A_V = +2.0$



**ON Semiconductor®**

<http://onsemi.com>



**SOT23-5  
(TSOP-5)  
SN SUFFIX  
CASE 483**

### MARKING DIAGRAM

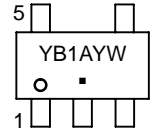

YB1 = Specific Device Code  
A = Assembly Location  
Y = Year  
W = Work Week  
▪ = Pb-Free Package

### SOT23-5 (TSOP-5) PINOUT

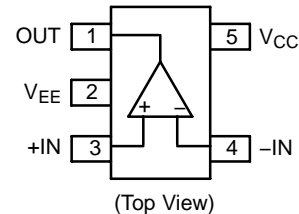

### ORDERING INFORMATION

Device	Package	Shipping†
NCS2510SNT1G	TSOP-5 (Pb-Free)	3000/Tape & Reel

†For information on tape and reel specifications, including part orientation and tape sizes, please refer to our Tape and Reel Packaging Specification Brochure, BRD8011/D.

# NCS2510

## PIN FUNCTION DESCRIPTION

Pin (SOT23/SC70)	Symbol	Function	Equivalent Circuit
1	OUT	Output	
2	$V_{EE}$	Negative Power Supply	
3	+IN	Non-inverted Input	
4	-IN	Inverted Input	See Above
5	$V_{CC}$	Positive Power Supply	

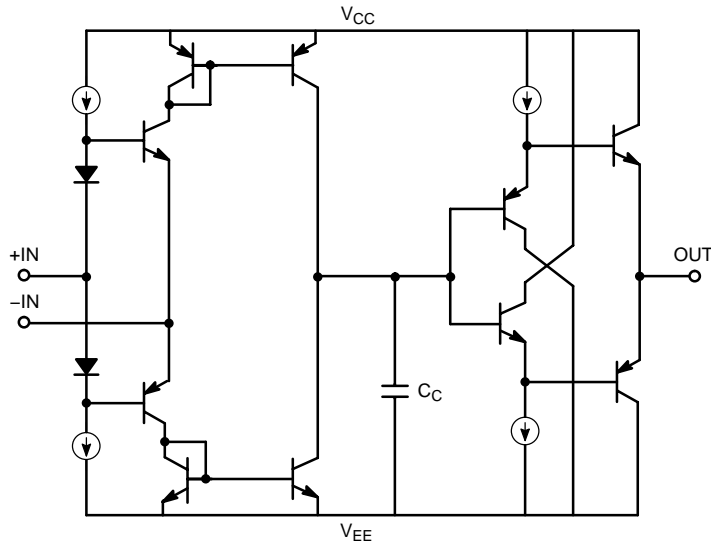

**Figure 2. Simplified Device Schematic**

# NCS2510

## ATTRIBUTES

Characteristics	Value
ESD	
Human Body Model	2.0 kV (Note 1)
Machine Model	200 V
Charged Device Model	1.0 kV
Moisture Sensitivity (Note 2)	Level 1
Flammability Rating    Oxygen Index: 28 to 34	UL 94 V-0 @ 0.125 in

- 0.8 kV between the input pairs +IN and -IN pins only. All other pins are 2.0 kV.
- For additional information, see Application Note AND8003/D.

## MAXIMUM RATINGS

Parameter	Symbol	Rating	Unit
Power Supply Voltage	$V_S$	11	Vdc
Input Voltage Range	$V_I$	$\leq V_S$	Vdc
Input Differential Voltage Range	$V_{ID}$	$\leq V_S$	Vdc
Output Current	$I_O$	120	mA
Maximum Junction Temperature (Note 3)	$T_J$	150	°C
Operating Ambient Temperature	$T_A$	-40 to +85	°C
Storage Temperature Range	$T_{stg}$	-60 to +150	°C
Power Dissipation	$P_D$	(See Graph)	mW
Thermal Resistance, Junction-to-Air	$R_{\theta JA}$	121	°C/W

Stresses exceeding Maximum Ratings may damage the device. Maximum Ratings are stress ratings only. Functional operation above the Recommended Operating Conditions is not implied. Extended exposure to stresses above the Recommended Operating Conditions may affect device reliability.

- Power dissipation must be considered to ensure maximum junction temperature ( $T_J$ ) is not exceeded.

## MAXIMUM POWER DISSIPATION

The maximum power that can be safely dissipated is limited by the associated rise in junction temperature. For the plastic packages, the maximum safe junction temperature is 150°C. If the maximum is exceeded momentarily, proper circuit operation will be restored as soon as the die temperature is reduced. Leaving the device in the “overheated” condition for an extended period can result in device damage. To ensure proper operation, it is important to observe the derating curves.

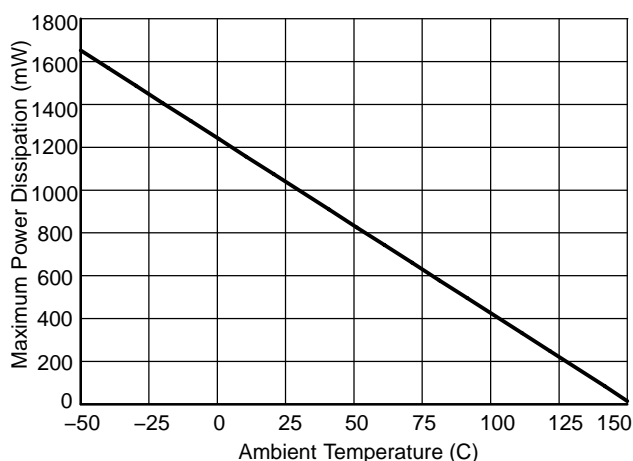

Figure 3. Power Dissipation vs. Temperature

# NCS2510

**AC ELECTRICAL CHARACTERISTICS** ( $V_{CC} = +5.0\text{ V}$ ,  $V_{EE} = -5.0\text{ V}$ ,  $T_A = -40^\circ\text{C}$  to  $+85^\circ\text{C}$ ,  $R_L = 150\ \Omega$  to GND,  $R_F = 330\ \Omega$ ,  $A_V = +2.0$ , Enable is left open, unless otherwise specified).

Symbol	Characteristic	Conditions	Min	Typ	Max	Unit
--------	----------------	------------	-----	-----	-----	------

## FREQUENCY DOMAIN PERFORMANCE

BW	Bandwidth 3.0 dB Small Signal 3.0 dB Large Signal	$A_V = +2.0$ , $V_O = 0.5\text{ V}_{p-p}$ $A_V = +2.0$ , $V_O = 2.0\text{ V}_{p-p}$		1400 650		MHz
$GF_{0.1dB}$	0.1 dB Gain Flatness Bandwidth	$A_V = +2.0$		120		MHz
dG	Differential Gain	$A_V = +2.0$ , $R_L = 150\ \Omega$ , $f = 3.58\text{ MHz}$		0.02		%
dP	Differential Phase	$A_V = +2.0$ , $R_L = 150\ \Omega$ , $f = 3.58\text{ MHz}$		0.02		°

## TIME DOMAIN RESPONSE

SR	Slew Rate	$A_V = +2.0$ , $V_{step} = 2.0\text{ V}$		2500		V/ $\mu\text{s}$
$t_s$	Settling Time 0.1%	$A_V = +2.0$ , $V_{step} = 2.0\text{ V}$		13		ns
$t_r$ $t_f$	Rise and Fall Time	(10%–90%) $A_V = +2.0$ , $V_{step} = 2.0\text{ V}$		1.5		ns

## HARMONIC/NOISE PERFORMANCE

THD	Total Harmonic Distortion	$f = 5.0\text{ MHz}$ , $V_O = 2.0\text{ V}_{p-p}$		-69		dB
HD2	2nd Harmonic Distortion	$f = 5.0\text{ MHz}$ , $V_O = 2.0\text{ V}_{p-p}$		-73		dBc
HD3	3rd Harmonic Distortion	$f = 5.0\text{ MHz}$ , $V_O = 2.0\text{ V}_{p-p}$		-73		dBc
IP3	Third-Order Intercept	$f = 10\text{ MHz}$ , $V_O = 1.0\text{ V}_{p-p}$		34		dBm
SFDR	Spurious-Free Dynamic Range	$f = 5.0\text{ MHz}$ , $V_O = 2.0\text{ V}_{p-p}$		73		dBc
$e_N$	Input Referred Voltage Noise	$f = 1.0\text{ MHz}$		5.0		nV/ $\sqrt{\text{Hz}}$
$i_N$	Input Referred Current Noise	$f = 1.0\text{ MHz}$ , Inverting $f = 1.0\text{ MHz}$ , Non-Inverting		20 30		pA/ $\sqrt{\text{Hz}}$

# NCS2510

**DC ELECTRICAL CHARACTERISTICS** ( $V_{CC} = +5.0\text{ V}$ ,  $V_{EE} = -5.0\text{ V}$ ,  $T_A = -40^\circ\text{C}$  to  $+85^\circ\text{C}$ ,  $R_L = 150\ \Omega$  to GND,  $R_F = 330\ \Omega$ ,  $A_V = +2.0$ , Enable is left open, unless otherwise specified).

Symbol	Characteristic	Conditions	Min	Typ	Max	Unit
--------	----------------	------------	-----	-----	-----	------

## DC PERFORMANCE

$V_{IO}$	Input Offset Voltage		-10	0	+10	mV
$\Delta V_{IO}/\Delta T$	Input Offset Voltage Temperature Coefficient			6.0		$\mu\text{V}/^\circ\text{C}$
$I_{IB}$	Input Bias Current	+Input (Non-Inverting), $V_O = 0\text{ V}$ -Input (Inverting), $V_O = 0\text{ V}$ (Note 4)		$\pm 3.0$ $\pm 6.0$	$\pm 35$ $\pm 35$	$\mu\text{A}$
$\Delta I_{IB}/\Delta T$	Input Bias Current Temperature Coefficient	+Input (Non-Inverting), $V_O = 0\text{ V}$ -Input (Inverting), $V_O = 0\text{ V}$		+40 -10		$\text{nA}/^\circ\text{C}$

## INPUT CHARACTERISTICS

$V_{CM}$	Input Common Mode Voltage Range (Note 4)		$\pm 3.0$	$\pm 4.0$		V
CMRR	Common Mode Rejection Ratio	(See Graph)	40	50		dB
$R_{IN}$	Input Resistance	+Input (Non-Inverting) -Input (Inverting)		150 70		$\text{k}\Omega$ $\Omega$
$C_{IN}$	Differential Input Capacitance			1.0		pF

## OUTPUT CHARACTERISTICS

$R_{OUT}$	Output Resistance	Closed Loop Open Loop		0.1 13		$\Omega$
$V_O$	Output Voltage Range		$\pm 3.0$	$\pm 4.0$		V
$I_O$	Output Current		$\pm 90$	$\pm 120$		mA

## POWER SUPPLY

$V_S$	Operating Voltage Supply			10		V
$I_S$	Power Supply Current	$V_O = 0\text{ V}$	6.0	12	18	mA
PSRR	Power Supply Rejection Ratio	(See Graph)	40	55		dB

4. Guaranteed by design and/or characterization.

# NCS2510

**AC ELECTRICAL CHARACTERISTICS** ( $V_{CC} = +2.5\text{ V}$ ,  $V_{EE} = -2.5\text{ V}$ ,  $T_A = -40^\circ\text{C}$  to  $+85^\circ\text{C}$ ,  $R_L = 150\ \Omega$  to GND,  $R_F = 330\ \Omega$ ,  $A_V = +2.0$ , Enable is left open, unless otherwise specified).

Symbol	Characteristic	Conditions	Min	Typ	Max	Unit
--------	----------------	------------	-----	-----	-----	------

## FREQUENCY DOMAIN PERFORMANCE

BW	Bandwidth 3.0 dB Small Signal 3.0 dB Large Signal	$A_V = +2.0$ , $V_O = 0.5\text{ V}_{p-p}$ $A_V = +2.0$ , $V_O = 1.0\text{ V}_{p-p}$		800 450		MHz
$GF_{0.1dB}$	0.1 dB Gain Flatness Bandwidth	$A_V = +2.0$		100		MHz
dG	Differential Gain	$A_V = +2.0$ , $R_L = 150\ \Omega$ , $f = 3.58\text{ MHz}$		0.02		%
dP	Differential Phase	$A_V = +2.0$ , $R_L = 150\ \Omega$ , $f = 3.58\text{ MHz}$		0.02		°

## TIME DOMAIN RESPONSE

SR	Slew Rate	$A_V = +2.0$ , $V_{step} = 1.0\text{ V}$		1500		V/ $\mu\text{s}$
$t_s$	Settling Time 0.1%	$A_V = +2.0$ , $V_{step} = 1.0\text{ V}$		10		ns
$t_r$ $t_f$	Rise and Fall Time	(10%–90%) $A_V = +2.0$ , $V_{step} = 1.0\text{ V}$		1.2		ns

## HARMONIC/NOISE PERFORMANCE

THD	Total Harmonic Distortion	$f = 5.0\text{ MHz}$ , $V_O = 1.0\text{ V}_{p-p}$		-58		dB
HD2	2nd Harmonic Distortion	$f = 5.0\text{ MHz}$ , $V_O = 1.0\text{ V}_{p-p}$		-61		dBc
HD3	3rd Harmonic Distortion	$f = 5.0\text{ MHz}$ , $V_O = 1.0\text{ V}_{p-p}$		-61		dBc
IP3	Third-Order Intercept	$f = 10\text{ MHz}$ , $V_O = .5\text{ V}_{p-p}$		28		dBm
SFDR	Spurious-Free Dynamic Range	$f = 5.0\text{ MHz}$ , $V_O = 1.0\text{ V}_{p-p}$		61		dBc
$e_N$	Input Referred Voltage Noise	$f = 1.0\text{ MHz}$		5.0		nV/ $\sqrt{\text{Hz}}$
$i_N$	Input Referred Current Noise	$f = 1.0\text{ MHz}$ , Inverting $f = 1.0\text{ MHz}$ , Non-Inverting		20 30		pA/ $\sqrt{\text{Hz}}$

# NCS2510

**DC ELECTRICAL CHARACTERISTICS** ( $V_{CC} = +2.5\text{ V}$ ,  $V_{EE} = -2.5\text{ V}$ ,  $T_A = -40^\circ\text{C}$  to  $+85^\circ\text{C}$ ,  $R_L = 150\ \Omega$  to GND,  $R_F = 330\ \Omega$ ,  $A_V = +2.0$ , Enable is left open, unless otherwise specified).

Symbol	Characteristic	Conditions	Min	Typ	Max	Unit
--------	----------------	------------	-----	-----	-----	------

## DC PERFORMANCE

$V_{IO}$	Input Offset Voltage		-10	0	+10	mV
$\Delta V_{IO}/\Delta T$	Input Offset Voltage Temperature Coefficient			6.0		$\mu\text{V}/^\circ\text{C}$
$I_{IB}$	Input Bias Current	+Input (Non-Inverting), $V_O = 0\text{ V}$ -Input (Inverting), $V_O = 0\text{ V}$ (Note 5)		$\pm 3.0$ $\pm 6.0$	$\pm 35$ $\pm 35$	$\mu\text{A}$
$\Delta I_{IB}/\Delta T$	Input Bias Current Temperature Coefficient	+Input (Non-Inverting), $V_O = 0\text{ V}$ -Input (Inverting), $V_O = 0\text{ V}$		+40 -10		$\text{nA}/^\circ\text{C}$

## INPUT CHARACTERISTICS

$V_{CM}$	Input Common Mode Voltage Range (Note 5)		$\pm 1.1$	$\pm 1.5$		V
CMRR	Common Mode Rejection Ratio	(See Graph)	40	50		dB
$R_{IN}$	Input Resistance	+Input (Non-Inverting) -Input (Inverting)		150 70		$\text{k}\Omega$ $\Omega$
$C_{IN}$	Differential Input Capacitance			1.0		pF

## OUTPUT CHARACTERISTICS

$R_{OUT}$	Output Resistance	Closed Loop Open Loop		0.1 13		$\Omega$
$V_O$	Output Voltage Range		$\pm 1.1$	$\pm 1.5$		V
$I_O$	Output Current		$\pm 90$	$\pm 120$		mA

## POWER SUPPLY

$V_S$	Operating Voltage Supply			5.0		V
$I_S$	Power Supply Current – Enabled	$V_O = 0\text{ V}$	6.0	11	18	mA
PSRR	Power Supply Rejection Ratio	(See Graph)	40	55		dB

5. Guaranteed by design and/or characterization.

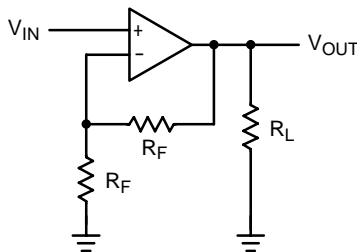

**Figure 4. Typical Test Setup**  
( $A_V = +2.0$ ,  $R_F = 330\ \Omega$ ,  $R_L = 150\ \Omega$ )

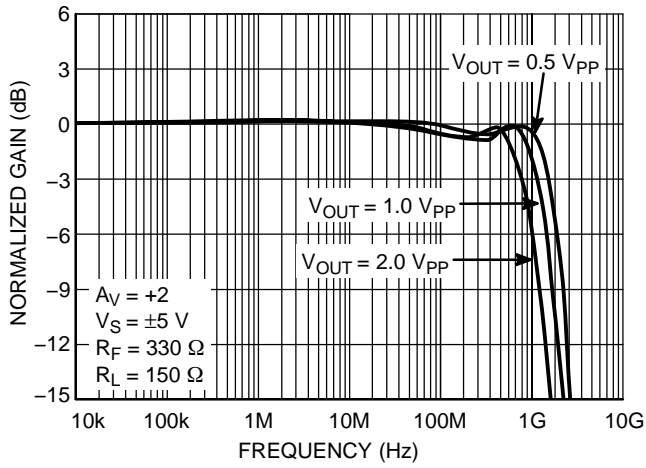

**Figure 5. Frequency Response:**  
Gain (dB) vs. Frequency  
 $A_V = +2.0$

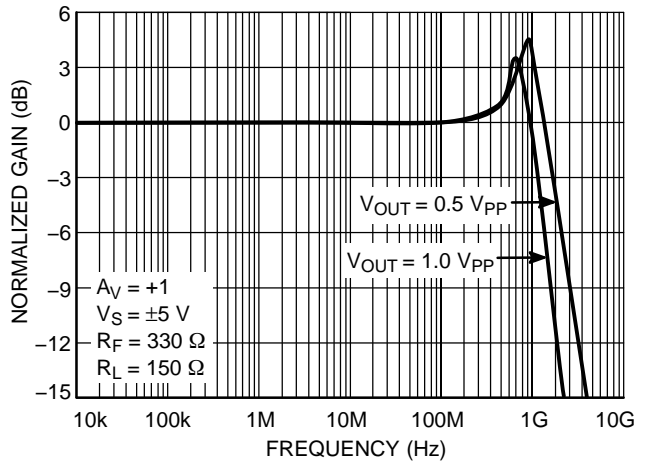

**Figure 6. Frequency Response:**  
Gain (dB) vs. Frequency  
 $A_V = +1.0$

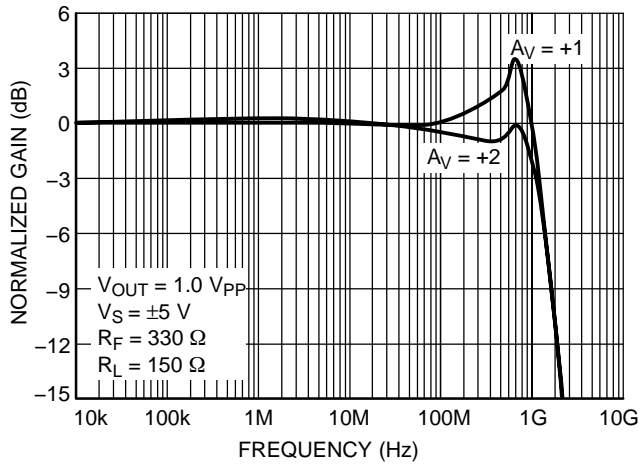

**Figure 7. Large Signal Frequency Response**  
Gain (dB) vs. Frequency

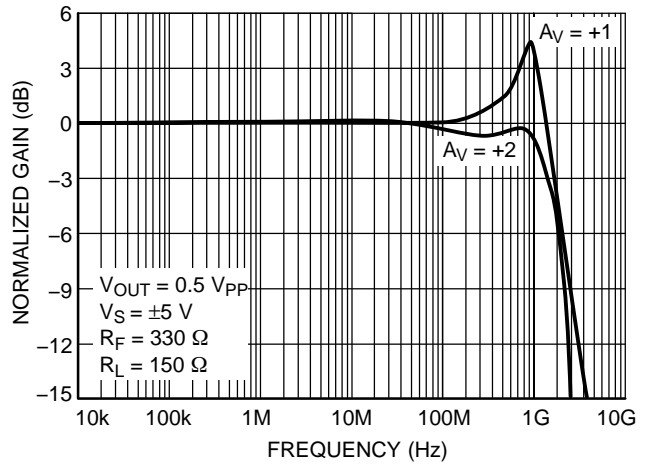

**Figure 8. Small Signal Frequency Response**  
Gain (dB) vs. Frequency

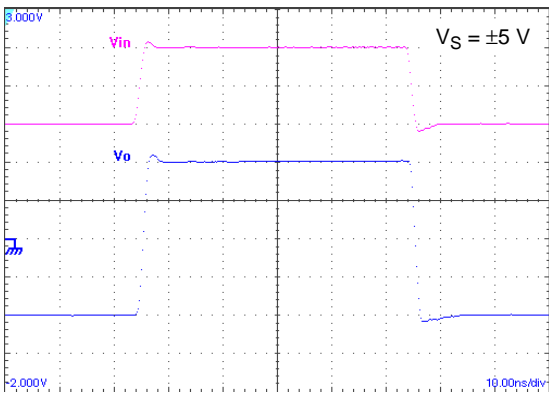

**Figure 9. Small Signal Step Response**  
Vertical: 500 mV/div  
Horizontal: 10 ns/div

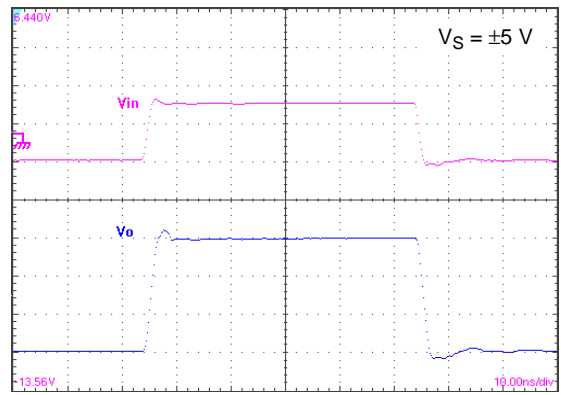

**Figure 10. Large Signal Step Response**  
Vertical: 2 V/div  
Horizontal: 10 ns/div



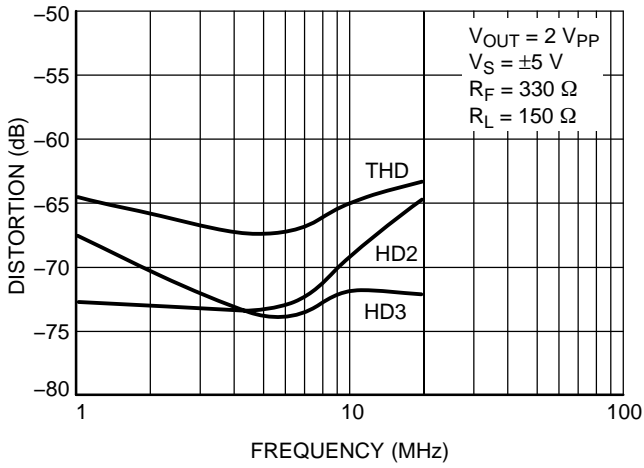

Figure 11. THD, HD2, HD3 vs. Frequency

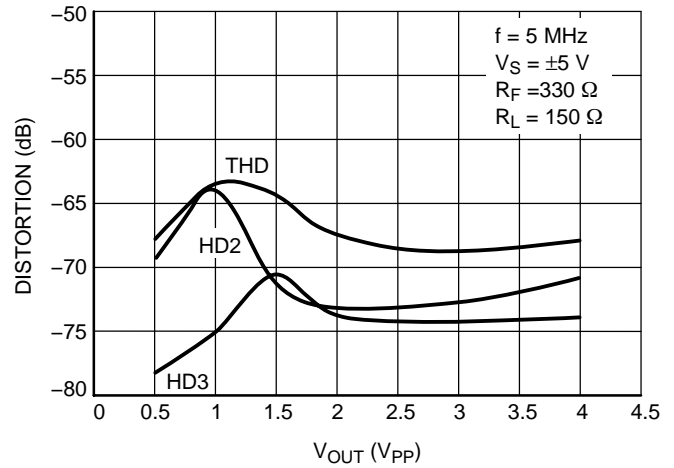

Figure 12. THD, HD2, HD3 vs. Frequency

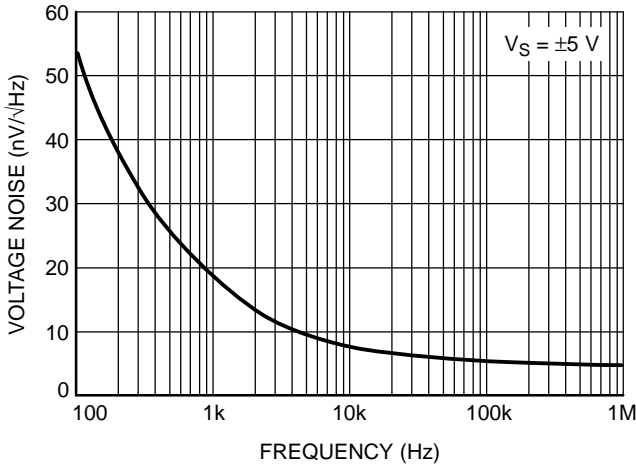

Figure 13. Input Referred Voltage Noise vs. Frequency

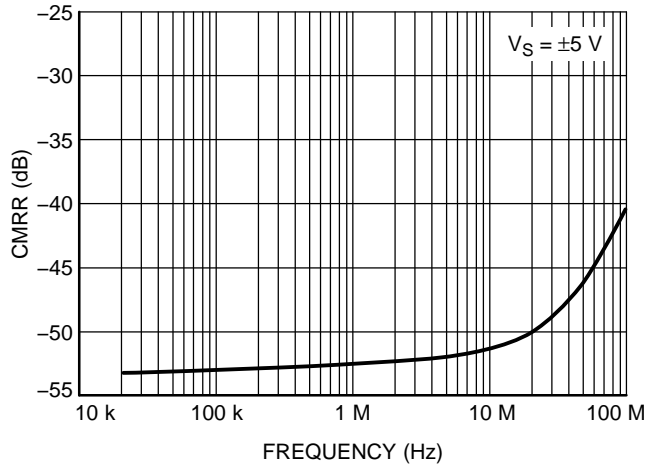

Figure 14. CMRR vs. Frequency

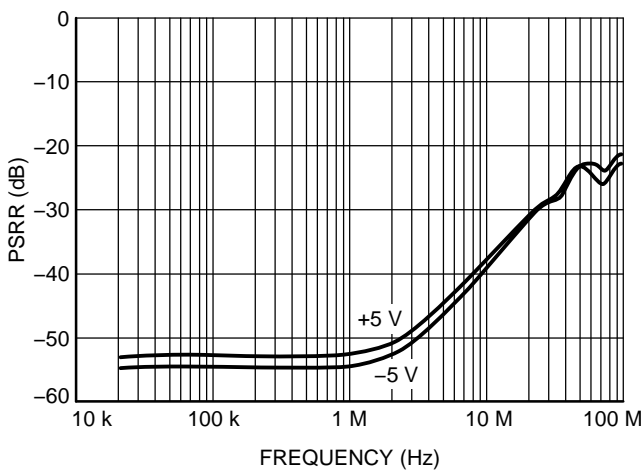

Figure 15. PSRR vs. Frequency

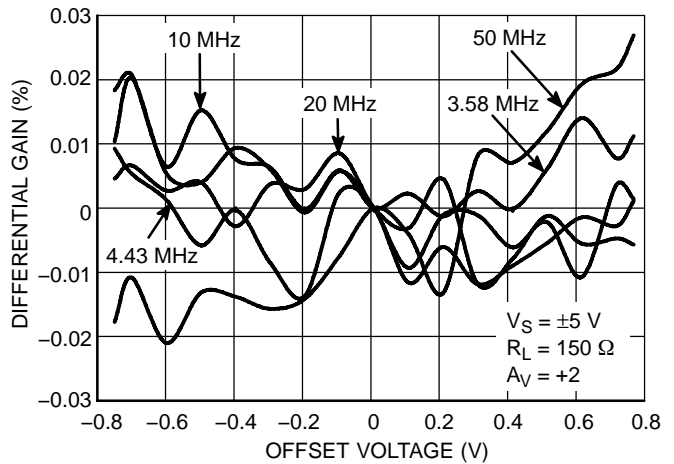

Figure 16. Differential Gain

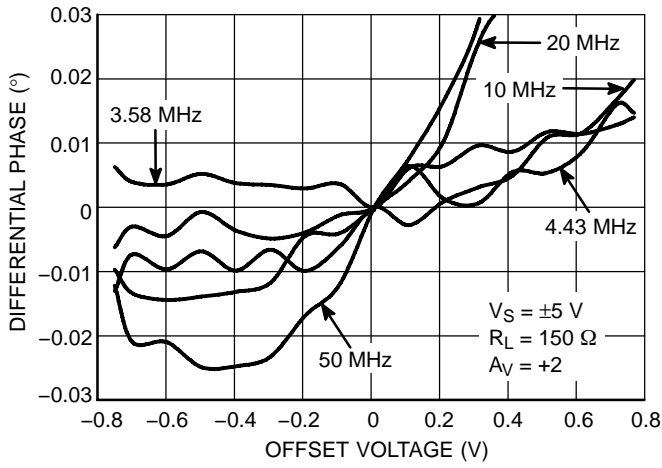

Figure 17. Differential Phase

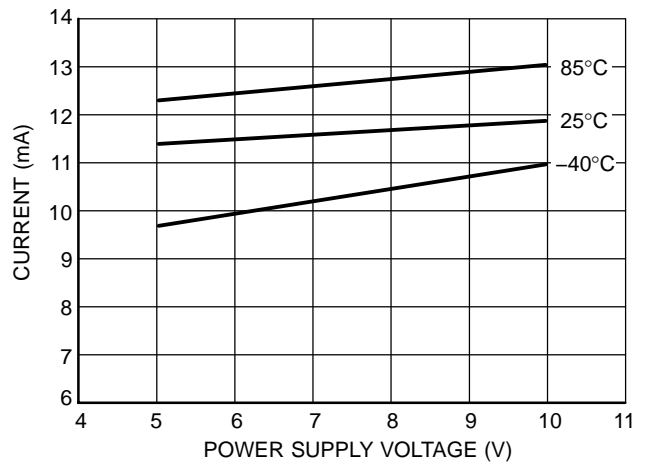

Figure 18. Supply Current vs. Power Supply (Enabled)

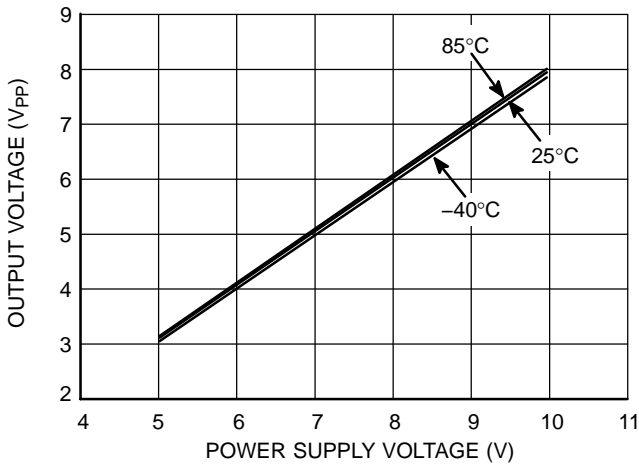

Figure 19. Output Voltage Swing vs. Supply Voltage

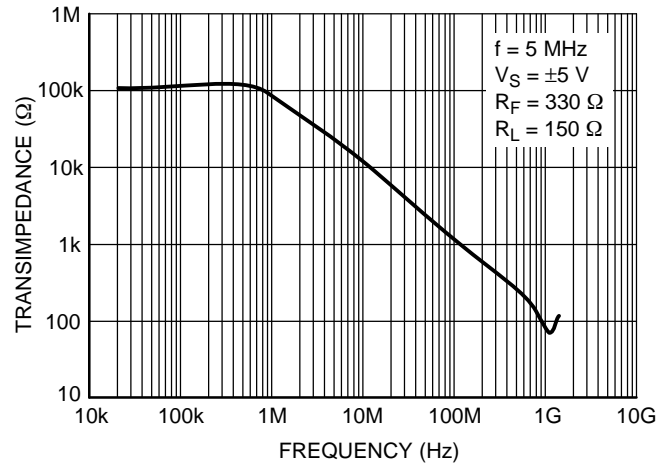

Figure 20. Transimpedance (ROL) vs. Frequency

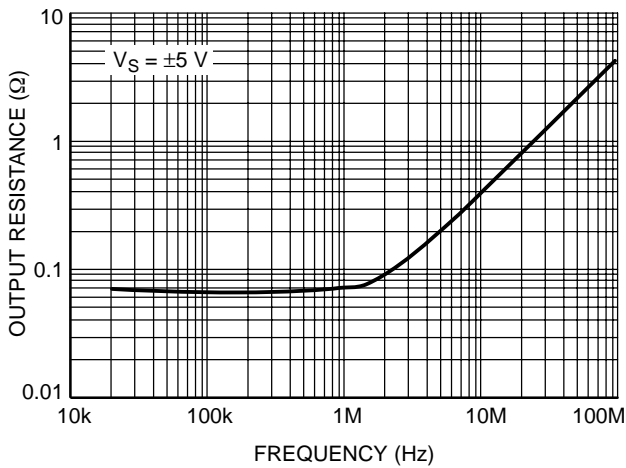

Figure 21. Closed-Loop Output Resistance vs. Frequency

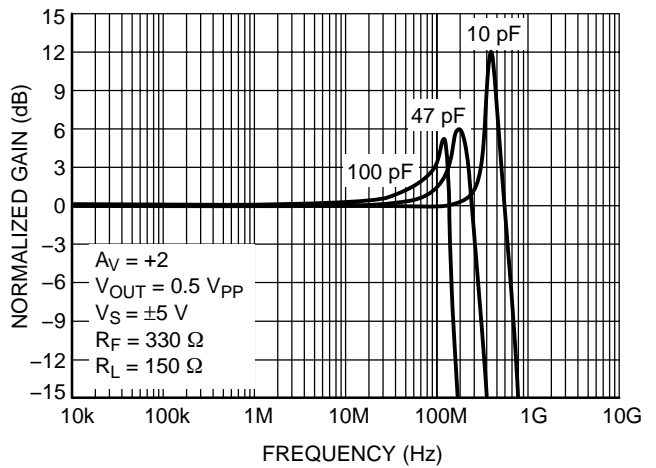
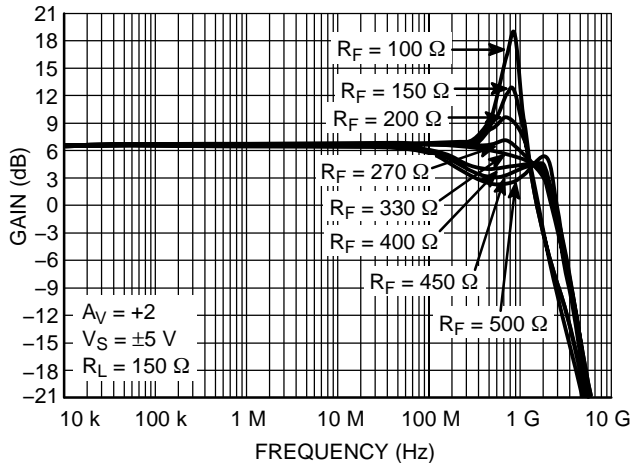

Figure 22. Frequency Response vs. Capacitive Load

**General Design Considerations**

The current feedback amplifier is optimized for use in high performance video and data acquisition systems. For current feedback architecture, its closed-loop bandwidth depends on the value of the feedback resistor. The closed-loop bandwidth is not a strong function of gain, as is for a voltage feedback amplifier, as shown in Figure 23.



**Figure 23. Frequency Response vs.  $R_F$**

The -3.0 dB bandwidth is, to some extent, dependent on the power supply voltages. By using lower power supplies, the bandwidth is reduced, because the internal capacitance increases. Smaller values of feedback resistor can be used at lower supply voltages, to compensate for this affect.

**Feedback and Gain Resistor Selection for Optimum Frequency Response**

A current feedback operational amplifier’s key advantage is the ability to maintain optimum frequency response independent of gain by using appropriate values for the feedback resistor. To obtain a very flat gain response, the feedback resistor tolerance should be considered as well. Resistor tolerance of 1% should be used for optimum flatness. Normally, lowering  $R_F$  resistor from its recommended value will peak the frequency response and extend the bandwidth while increasing the value of  $R_F$  resistor will cause the frequency response to roll off faster. Reducing the value of  $R_F$  resistor too far below its recommended value will cause overshoot, ringing, and eventually oscillation.

Since each application is slightly different, it is worth some experimentation to find the optimal  $R_F$  for a given circuit. A value of the feedback resistor that produces ~0.1 dB of peaking is the best compromise between stability and maximal bandwidth. It is not recommended to

use a current feedback amplifier with the output shorted directly to the inverting input.

**Printed Circuit Board Layout Techniques**

Proper high speed PCB design rules should be used for all wideband amplifiers as the PCB parasitics can affect the overall performance. Most important are stray capacitances at the output and inverting input nodes as it can effect peaking and bandwidth. A space (3/16" is plenty) should be left around the signal lines to minimize coupling. Also, signal lines connecting the feedback and gain resistors should be short enough so that their associated inductance does not cause high frequency gain errors. Line lengths less than 1/4" are recommended.

**Video Performance**

This device designed to provide good performance with NTSC, PAL, and HDTV video signals. Best performance is obtained with back terminated loads as performance is degraded as the load is increased. The back termination reduces reflections from the transmission line and effectively masks transmission line and other parasitic capacitances from the amplifier output stage.

**ESD Protection**

All device pins have limited ESD protection using internal diodes to power supplies as specified in the attributes table (see Figure 24). These diodes provide moderate protection to input overdrive voltages above the supplies. The ESD diodes can support high input currents with current limiting series resistors. Keep these resistor values as low as possible since high values degrade both noise performance and frequency response. Under closed-loop operation, the ESD diodes have no effect on circuit performance. However, under certain conditions the ESD diodes will be evident. If the device is driven into a slewing condition, the ESD diodes will clamp large differential voltages until the feedback loop restores closed-loop operation. Also, if the device is powered down and a large input signal is applied, the ESD diodes will conduct.

NOTE: Human Body Model for +IN and -IN pins are rated at 0.8kV while all other pins are rated at 2.0kV.

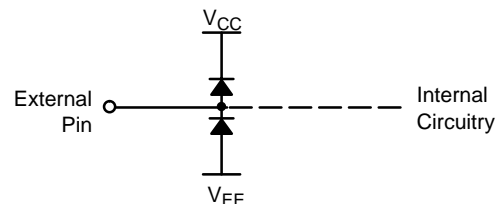
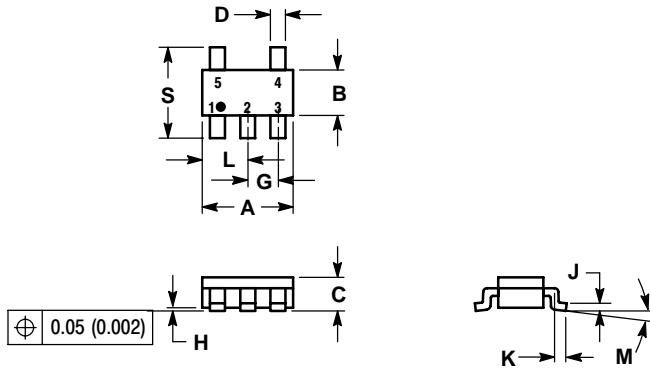

**Figure 24. Internal ESD Protection**

# NCS2510

## PACKAGE DIMENSIONS

TSOP-5  
SN SUFFIX  
CASE 483-02  
ISSUE E



### NOTES:

1. DIMENSIONING AND TOLERANCING PER ANSI Y14.5M, 1982.
2. CONTROLLING DIMENSION: MILLIMETER.
3. MAXIMUM LEAD THICKNESS INCLUDES LEAD FINISH THICKNESS. MINIMUM LEAD THICKNESS IS THE MINIMUM THICKNESS OF BASE MATERIAL.
4. A AND B DIMENSIONS DO NOT INCLUDE MOLD FLASH, PROTRUSIONS, OR GATE BURRS.

DIM	MILLIMETERS		INCHES	
	MIN	MAX	MIN	MAX
A	2.90	3.10	0.1142	0.1220
B	1.30	1.70	0.0512	0.0669
C	0.90	1.10	0.0354	0.0433
D	0.25	0.50	0.0098	0.0197
G	0.85	1.05	0.0335	0.0413
H	0.013	0.100	0.0005	0.0040
J	0.10	0.26	0.0040	0.0102
K	0.20	0.60	0.0079	0.0236
L	1.25	1.55	0.0493	0.0610
M	0°	10°	0°	10°
S	2.50	3.00	0.0985	0.1181

### SOLDERING FOOTPRINT\*

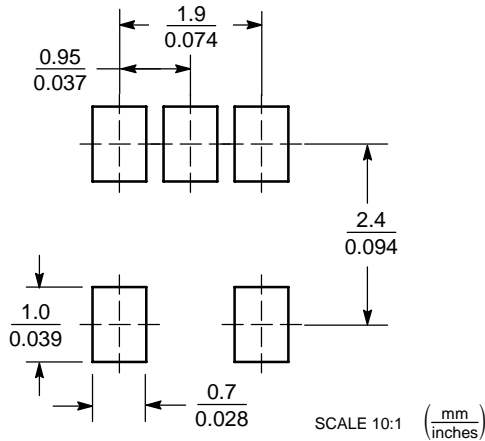

\*For additional information on our Pb-Free strategy and soldering details, please download the ON Semiconductor Soldering and Mounting Techniques Reference Manual, SOLDERRM/D.

ON Semiconductor and are registered trademarks of Semiconductor Components Industries, LLC (SCILLC). SCILLC reserves the right to make changes without further notice to any products herein. SCILLC makes no warranty, representation or guarantee regarding the suitability of its products for any particular purpose, nor does SCILLC assume any liability arising out of the application or use of any product or circuit, and specifically disclaims any and all liability, including without limitation special, consequential or incidental damages. "Typical" parameters which may be provided in SCILLC data sheets and/or specifications can and do vary in different applications and actual performance may vary over time. All operating parameters, including "Typicals" must be validated for each customer application by customer's technical experts. SCILLC does not convey any license under its patent rights nor the rights of others. SCILLC products are not designed, intended, or authorized for use as components in systems intended for surgical implant into the body, or other applications intended to support or sustain life, or for any other application in which the failure of the SCILLC product could create a situation where personal injury or death may occur. Should Buyer purchase or use SCILLC products for any such unintended or unauthorized application, Buyer shall indemnify and hold SCILLC and its officers, employees, subsidiaries, affiliates, and distributors harmless against all claims, costs, damages, and expenses, and reasonable attorney fees arising out of, directly or indirectly, any claim of personal injury or death associated with such unintended or unauthorized use, even if such claim alleges that SCILLC was negligent regarding the design or manufacture of the part. SCILLC is an Equal Opportunity/Affirmative Action Employer. This literature is subject to all applicable copyright laws and is not for resale in any manner.

### PUBLICATION ORDERING INFORMATION

**LITERATURE FULFILLMENT:**  
Literature Distribution Center for ON Semiconductor  
P.O. Box 61312, Phoenix, Arizona 85082-1312 USA  
**Phone:** 480-829-7710 or 800-344-3860 Toll Free USA/Canada  
**Fax:** 480-829-7709 or 800-344-3867 Toll Free USA/Canada  
**Email:** orderlit@onsemi.com

**N. American Technical Support:** 800-282-9855 Toll Free  
USA/Canada

**Japan:** ON Semiconductor, Japan Customer Focus Center  
2-9-1 Kamimeguro, Meguro-ku, Tokyo, Japan 153-0051  
**Phone:** 81-3-5773-3850

**ON Semiconductor Website:** <http://onsemi.com>

**Order Literature:** <http://www.onsemi.com/litorder>

For additional information, please contact your local Sales Representative.