

INTERNATIONAL RECTIFIER

AVALANCHE ENERGY RATED AND dv/dt RATED

HEXFET® TRANSISTOR

IRFI064

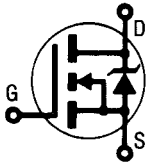

N-CHANNEL

60 Volt, 0.017 Ohm HEXFET

The HEXFET® technology is the key to International Rectifier's advanced line of power MOSFET transistors. The efficient geometry design achieves very low on-state resistance combined with high transconductance.

The HEXFET transistors also feature all of the well established advantages of MOSFETs such as voltage control, very fast switching, ease of paralleling and temperature stability of the electrical parameters.

They are well suited for applications such as switching power supplies and virtually any application where military and/or high reliability is required.

Product Summary

Part Number	V_{DSS}	$R_{DS(on)}$	I_D
IRFI064	60V	0.017Ω	45A*

FEATURES:

- Avalanche Energy Rating
- Isolated and Hermetically Sealed
- Alternative to TO-3 Package
- Simple Drive Requirements
- Ease of Paralleling
- Ceramic Eyelets

CASE STYLE AND DIMENSIONS

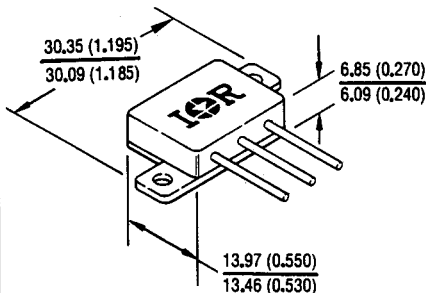

CAUTION

**BERYLLIA WARNING PER MIL-S-19500
SEE PAGE I-251**

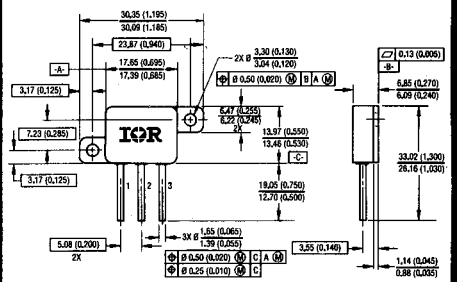

NOTES:

- 1 DIMENSIONING & TOLERANCING PER ANSI Y14.5M - 1982.
- 2 DIMENSIONS ARE SHOWN IN MILLIMETERS (INCHES).

LEGEND

- 1 DRAIN
- 2 SOURCE
- 3 GATE

*For optional leadforms see page I-251, fig. 15

Conforms to JEDEC Outline TO-259AA*
Dimensions in Millimeters and (Inches)

Absolute Maximum Ratings

Parameter	IRFI064	Units
I_D @ $V_{GS} = 10V$, $T_C = 25^\circ C$	Continuous Drain Current	45*
I_D @ $V_{GS} = 10V$, $T_C = 100^\circ C$	Continuous Drain Current	45*
I_{DM}	Pulsed Drain Current ①	400
P_D @ $T_C = 25^\circ C$	Max. Power Dissipation	300
	Linear Derating Factor	2.4
V_{GS}	Gate-to-Source Voltage	± 20
EAS	Single Pulse Avalanche Energy ②	620
dv/dt	Peak Diode Recovery dv/dt ③	4.5
T_J	Operating Junction	-55 to 150
T_{STG}	Storage Temperature Range	
	Lead Temperature	300 (0.063 in. (1.6 mm) from case for 10s)
	Weight	10.9 (typical)
		g

* I_D current limited by pin diameter

Electrical Characteristics @ $T_J = 25^\circ C$ (Unless Otherwise Specified)

Parameter	Min.	Typ.	Max.	Units	Test Conditions	
BV_{DSS}	Drain-to-Source Breakdown Voltage	60	—	—	V	$V_{GS} = 0V$, $I_D = 1.0$ mA
$\Delta BV_{DSS}/\Delta T_J$	Temperature Coefficient of Breakdown Voltage	—	0.048	—	V/ $^\circ C$	Reference to $25^\circ C$, $I_D = 1.0$ mA
$R_{DS(on)}$	Static Drain-to-Source On-State Resistance	—	—	0.017	Ω	$V_{GS} = 10V$, $I_D = 45A$ ④
$V_{GS(th)}$	Gate Threshold Voltage	2.0	—	4.0	V	$V_{DS} = V_{GS}$, $I_D = 250$ μA
g_{fs}	Forward Transconductance	21	—	—	S (ft)	$V_{DS} \geq 15V$, $I_{DS} = 45A$ ④
I_{DSS}	Zero Gate Voltage Drain Current	—	—	25	μA	$V_{DS} = 0.8 \times$ Max. Rating, $V_{GS} = 0V$
		—	—	250		$V_{DS} = 0.8 \times$ Max. Rating $V_{GS} = 0V$, $T_J = 125^\circ C$
I_{GSS}	Gate-to-Source Leakage Forward	—	—	100	nA	$V_{GS} = 20V$
I_{GSS}	Gate-to-Source Leakage Reverse	—	—	-100		$V_{GS} = -20V$
Q_g	Total Gate Charge	—	—	240		$V_{GS} = 10V$, $I_D = 45A$
Q_{gs}	Gate-to-Source Charge	—	—	53	nC	$V_{DS} = 0.5 \times$ Max. Rating
Q_{gd}	Gate-to-Drain ("Miller") Charge	—	—	78		See Fig. 6 and 14
$t_{d(on)}$	Turn-On Delay Time	—	—	27		$V_{DD} = 30V$, $I_D = 45A$, $R_G = 2.35\Omega$
t_r	Rise Time	—	—	120	ns	
$t_{d(off)}$	Turn-Off Delay Time	—	—	76		See Fig. 11
t_f	Fall Time	—	—	93		
L_D	Internal Drain Inductance	—	5.0	—	nH	Measured from the drain lead, 6 mm (0.25 in.) from package to center of die.
L_S	Internal Source Inductance	—	13	—		Measured from the source lead, 6 mm (0.25 in.) from package to source bonding pad.
C_{iss}	Input Capacitance	—	7400	—	pF	$V_{GS} = 0V$, $V_{DS} = 25V$
C_{oss}	Output Capacitance	—	3200	—		$f = 1.0$ MHz
C_{rss}	Reverse Transfer Capacitance	—	540	—		See Fig. 5
C_{DC}	Drain-to-Case Capacitance	—	12	—		$f = 1.0$ MHz

Modified MOSFET symbol showing the internal inductances.



Source-Drain Diode Ratings and Characteristics

Parameter	Min.	Typ.	Max.	Units	Test Conditions
I_S Continuous Source Current (Body Diode)	—	—	45*	A	Modified MOSFET symbol showing the integral Reverse p-n junction rectifier. 
I_{SM} Pulsed Source Current (Body Diode) ①	—	—	400		
V_{SD} Diode Forward Voltage	—	—	3.0	V	$T_J = 25^\circ\text{C}$, $I_S = 45\text{A}$, $V_{GS} = 0\text{V}$ ④
t_{rr} Reverse Recovery Time	—	—	220	nS	$T_J = 25^\circ\text{C}$, $I_F = 45\text{A}$, $di/dt = \leq 100\text{A}/\mu\text{s}$ ④
Q_{RR} Reverse Recovery Charge	—	—	1.1	μC	$V_{DD} \leq 50\text{V}$
t_{on} Forward Turn-On Time	Intrinsic turn-on time is negligible. Turn-on speed is substantially controlled by $L_S + L_D$.				

* I_S current limited by pin diameter

Thermal Resistance

Parameter	Min.	Typ.	Max.	Units	Test Conditions
R_{thJC} Junction-to-Case	—	—	0.42	K/W ⑤	Mounting surface flat, smooth, and greased Typical socket mount
R_{thCS} Case-to-Sink	—	0.21	—		
R_{thJA} Junction-to-Ambient	—	—	30		

① Repetitive Rating; Pulse width limited by maximum junction temperature (see figure 9) Refer to current HEXFET reliability report

② @ $V_{DD} = 25\text{V}$, Starting $T_J = 25^\circ\text{C}$,
 $L \geq 79\text{mH}$, $R_G = 25\Omega$,
Peak $I_L = 45\text{A}$

③ $I_{SD} \leq 130\text{A}$, $di/dt \leq 300\text{A}/\mu\text{s}$,
 $V_{DD} \leq BV_{DSS}$, $T_J \leq 125^\circ\text{C}$
Suggested $R_G = 2.35\Omega$

④ Pulse width $\leq 300\mu\text{s}$; Duty Cycle $\leq 2\%$

⑤ $K/W = ^\circ\text{C}/\text{W}$
 $W/K = \text{W}/^\circ\text{C}$

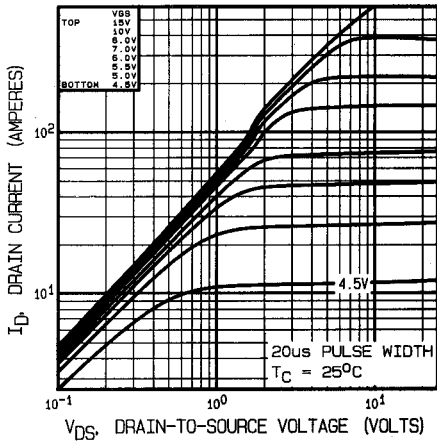

Fig. 1 — Typical Output Characteristics, $T_C = 25^\circ\text{C}$

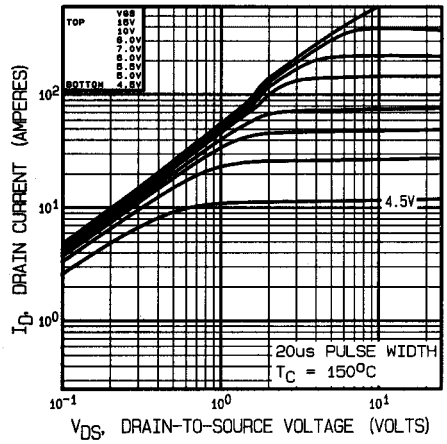

Fig. 2 — Typical Output Characteristics, $T_C = 150^\circ\text{C}$

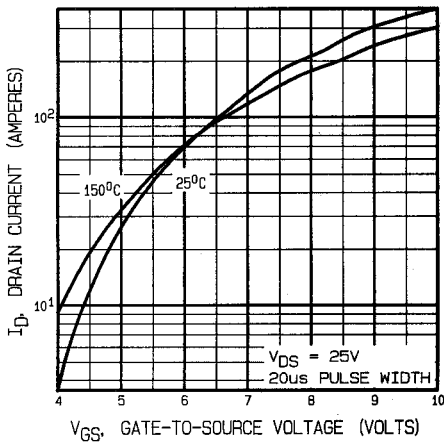

Fig. 3 — Typical Transfer Characteristics

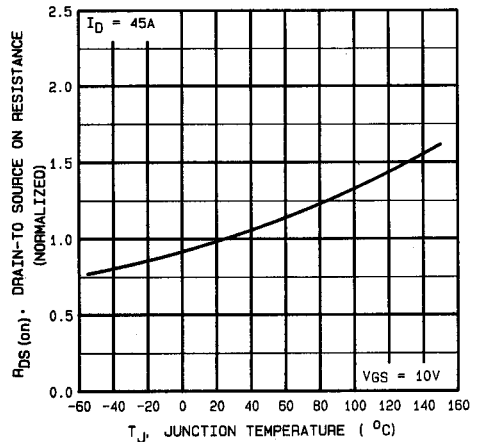
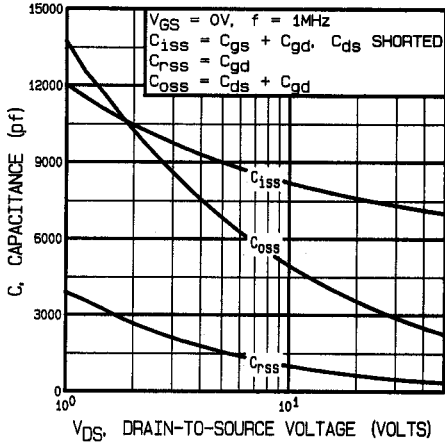
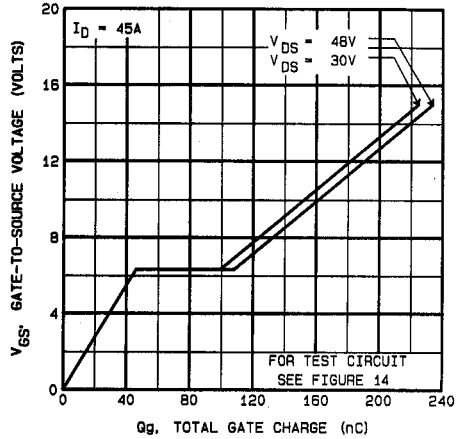
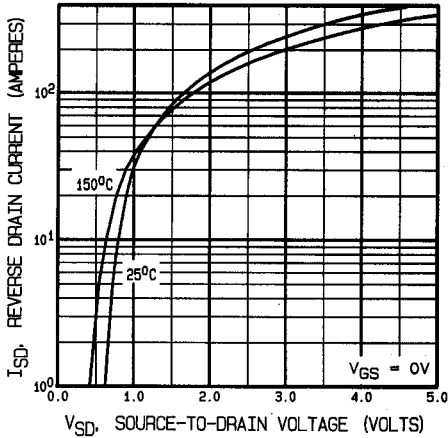
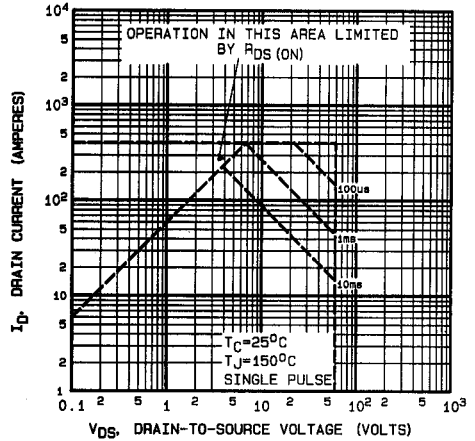

Fig. 4 — Normalized On-Resistance Vs. Temperature

Fig. 5 — Typical Capacitance Vs. Drain-to-Source Voltage

Fig. 6 — Typical Gate Charge Vs. Gate-to-Source Voltage

Fig. 7 — Typical Source-Drain Diode Forward Voltage

Fig. 8 — Maximum Safe Operating Area

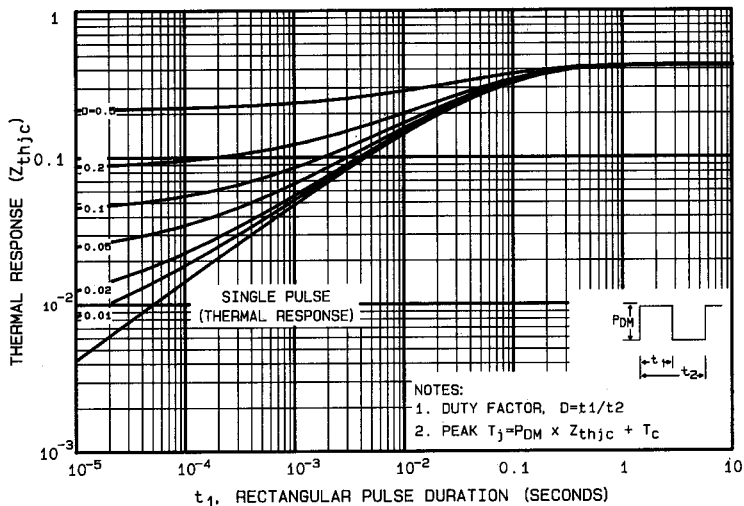

Fig. 9 — Maximum Effective Transient Thermal Impedance, Junction-to-Case Vs. Pulse Duration

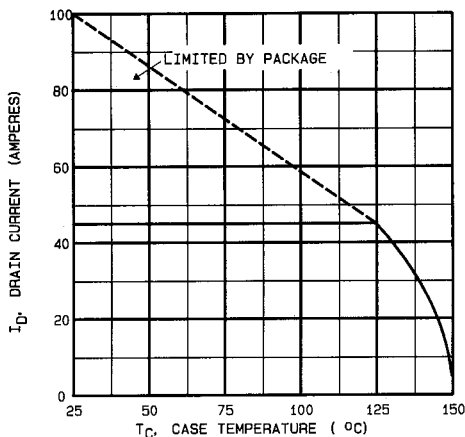

Fig. 10 — Maximum Drain Current Vs. Case Temperature

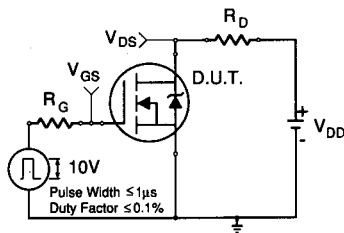

Fig. 11a — Switching Time Test Circuit

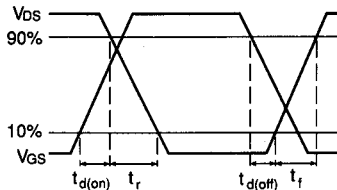

Fig. 11b — Switching Time Waveforms

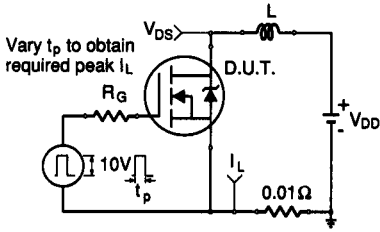

Fig. 12a — Unclamped Inductive Test Circuit

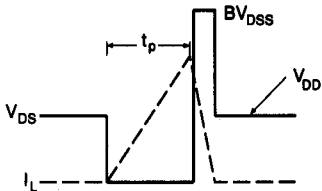

Fig. 12b — Unclamped Inductive Waveforms

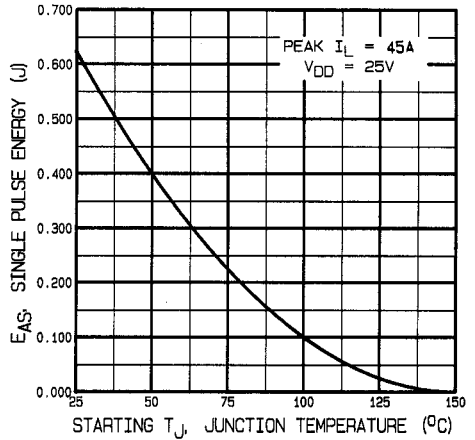
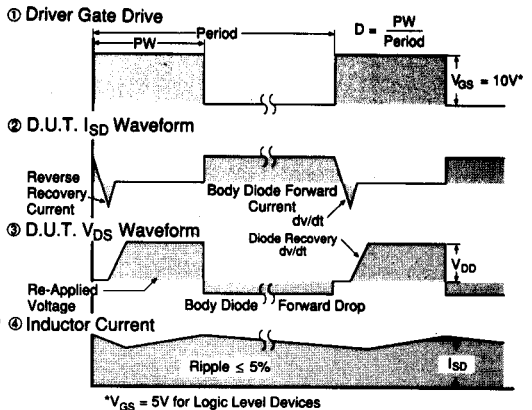
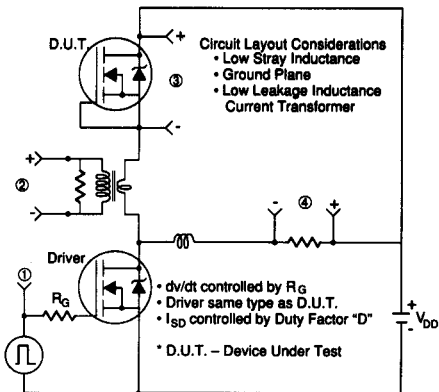

Fig. 12c — Maximum Avalanche Energy Vs. Starting Junction Temperature

 Fig. 13 — Peak Diode Recovery dv/dt Test Circuit

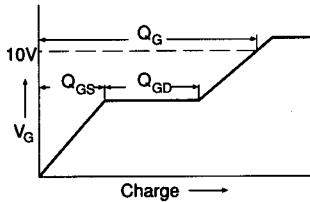

Fig. 14a — Basic Gate Charge Waveform

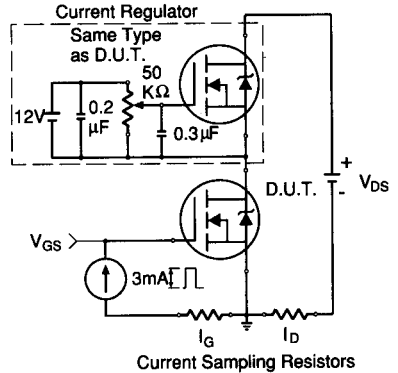

Fig. 14b — Gate Charge Test Circuit

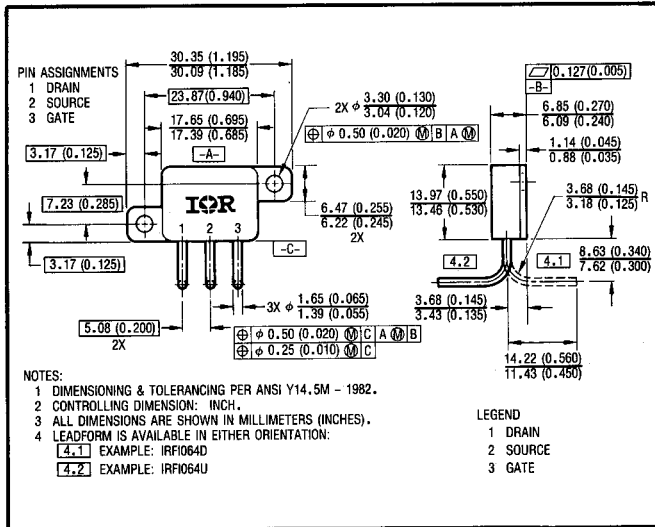

Fig. 15 — Optional Leadforms for Outline TO-259

BERYLLIA WARNING PER MIL-S-19500

Packages containing beryllia shall not be ground, sandblasted, machined, or have other operations performed on them which will produce beryllia or beryllium dust. Furthermore, beryllium oxide packages shall not be placed in acids that will produce fumes containing beryllium.