

SBD Type : C10T03QL

OUTLINE DRAWING

構造 : ショトキバリアダイオード(S B D)
 Construction: Schottky Barrier Diode

用途 : 高周波整流用
 Application : High Frequency Rectification

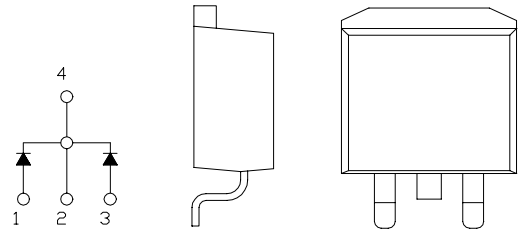

最大定格 / Maximum Ratings

Approx Net Weight:1.4g

Rating	Symbol	C10T03QL			Unit
くり返しピーク逆電圧 Repetitive Peak Reverse Voltage	V_{RRM}	30			V
くり返しピークサージ逆電圧 Repetitive Peak Surge Reverse Voltage	V_{RRSM}	35(pulse width 1 μ s duty 1/50)			V
平均整流電流 Average Rectified Output Current	I_O	10	$T_c=116$	50 Hz、正弦全波通電抵抗負荷 Full Sine Wave, Resistive Load	A
実効順電流 RMS Forward Current	$I_{F(RMS)}$	11.1			A
サージ順電流 Surge Forward Current	I_{FSM}	120	50 Hz 正弦全波, 1サイクル, 非くり返し Full Sine Wave, 1cycle, Non-repetitive		A
動作接合温度範囲 Operating Junction Temperature Range	T_{jw}	- 40 ~ + 150			
保存温度範囲 Storage Temperature Range	T_{stg}	- 40 ~ + 150			

電氣的・熱的特性 / Electrical · Thermal Characteristics

Characteristics	Symbol	Conditions	Min.	Typ.	Max.	Unit
ピーク逆電流 Peak Reverse Current	I_{RM}	$T_j = 25$, $V_{RM} = V_{RRM}$ per arm	-	-	5	mA
ピーク順電圧 Peak Forward Voltage	V_{FM}	$T_j = 25$, $I_{FM} = 5$ A per arm	-	-	0.47	V
熱抵抗(接合部・ケース間) Thermal Resistance(Junction to Case)	$R_{th(j-c)}$	Junction to Case	-	-	3	/W

C10T03QL 外形図(mm)

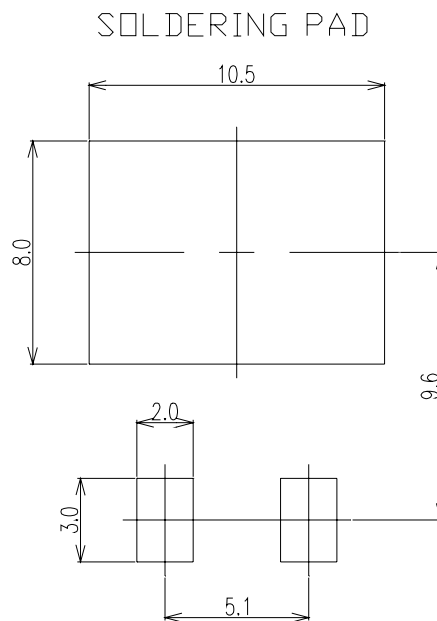
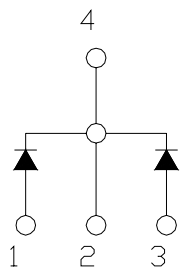
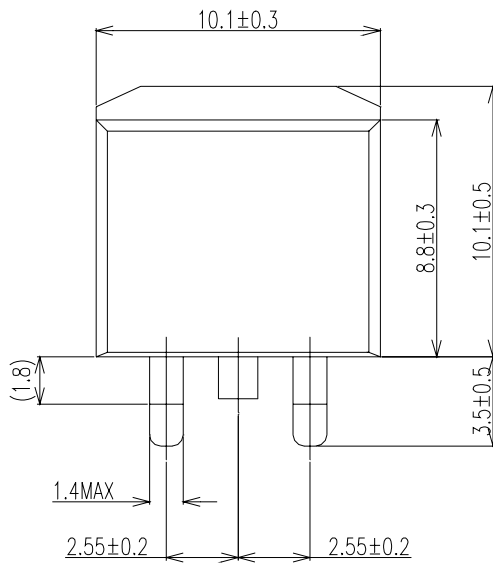
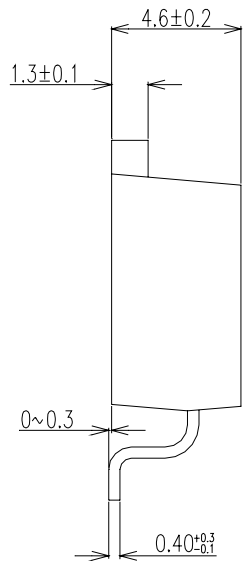

順電压特性
FORWARD CURRENT VS. VOLTAGE

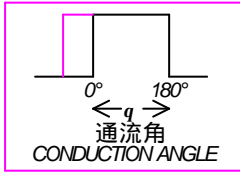
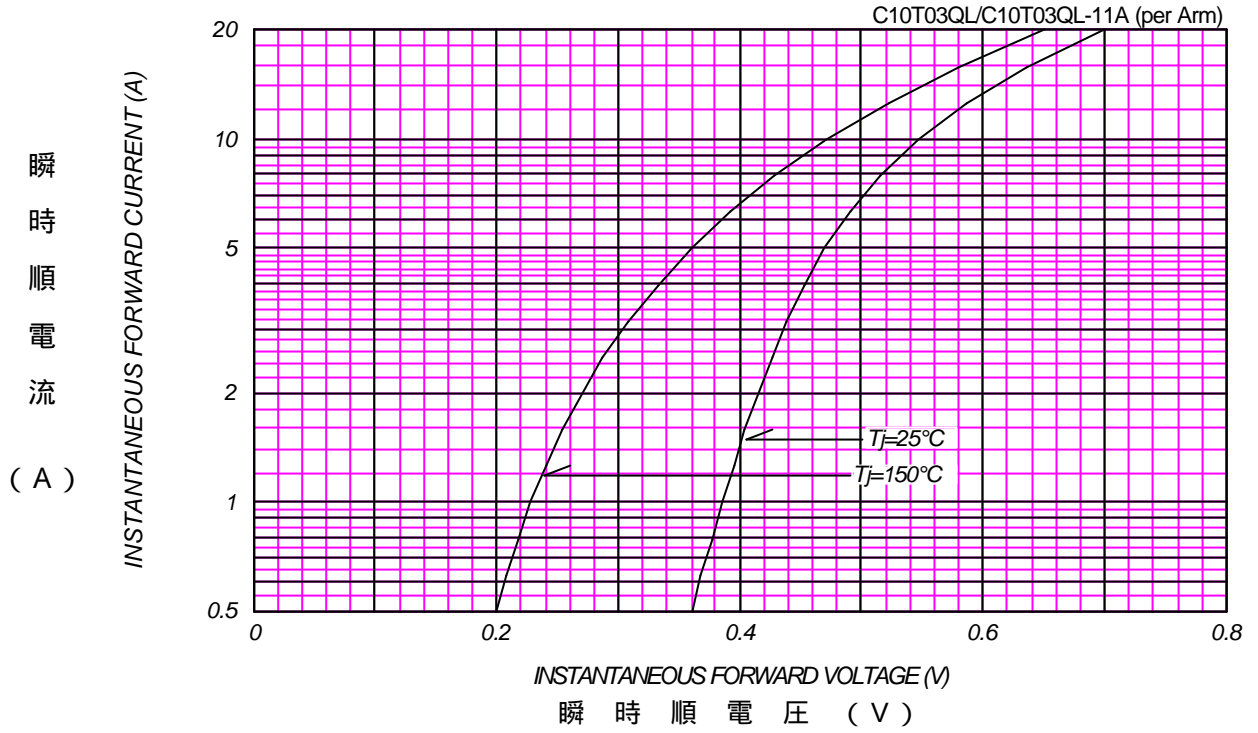

平均順電力損失特性
AVERAGE FORWARD POWER DISSIPATION

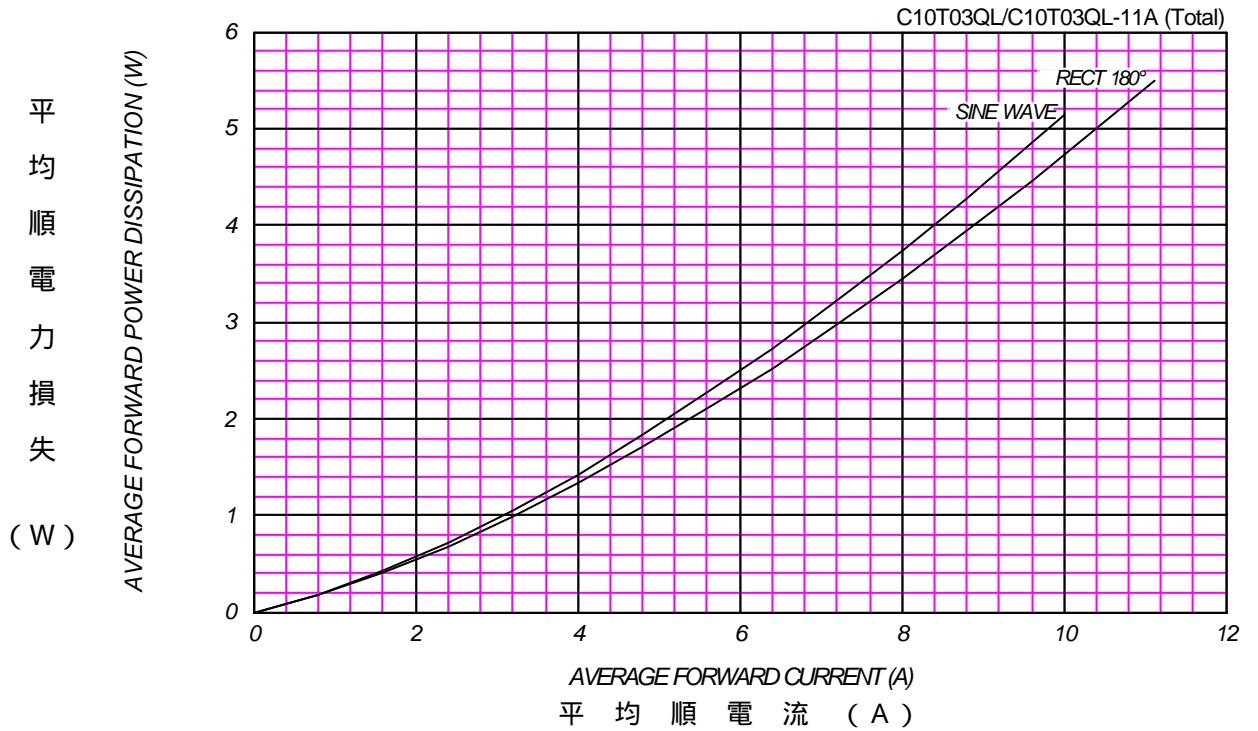

ピーク逆電流 - ピーク逆電圧特性
 PEAK REVERSE CURRENT VS. PEAK REVERSE VOLTAGE

T_j = 150 °C

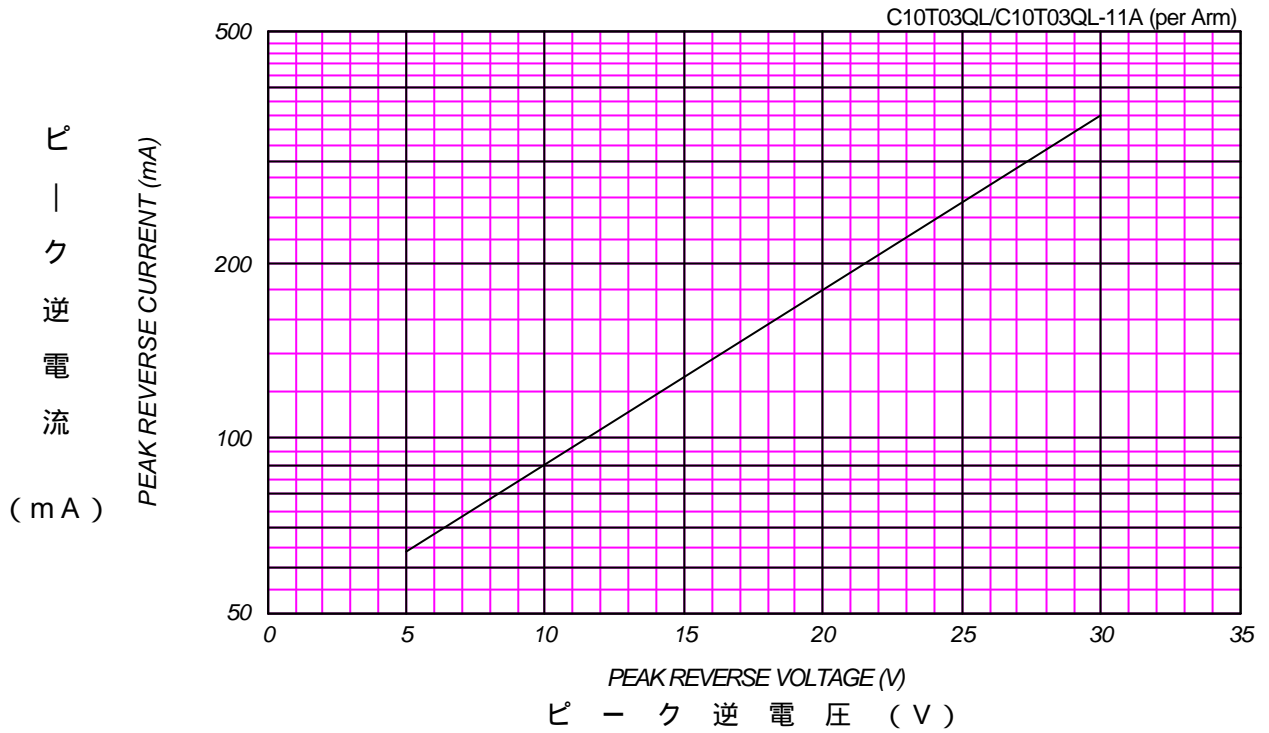

平均逆電力損失
 AVERAGE REVERSE POWER DISSIPATION

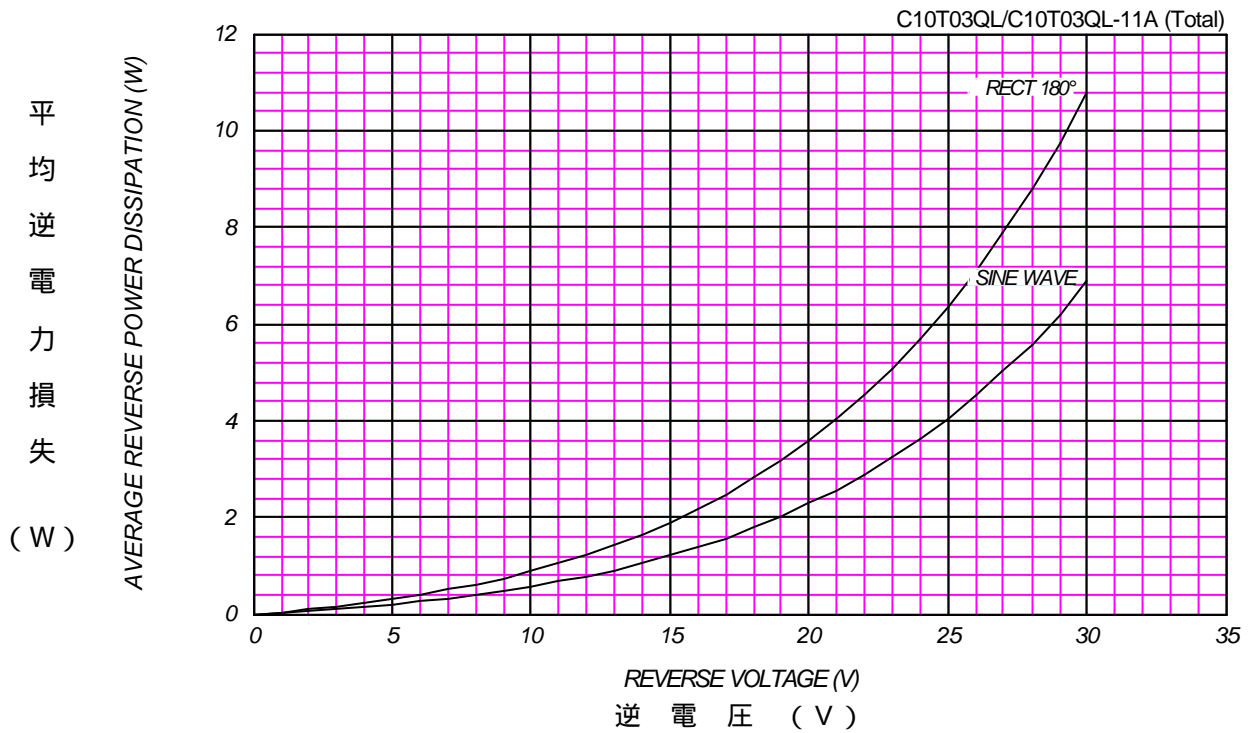

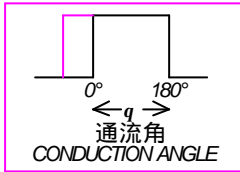

平均順電流 - ケース温度定格
AVERAGE FORWARD CURRENT VS. CASE TEMPERATURE

$V_{RM}=30V$

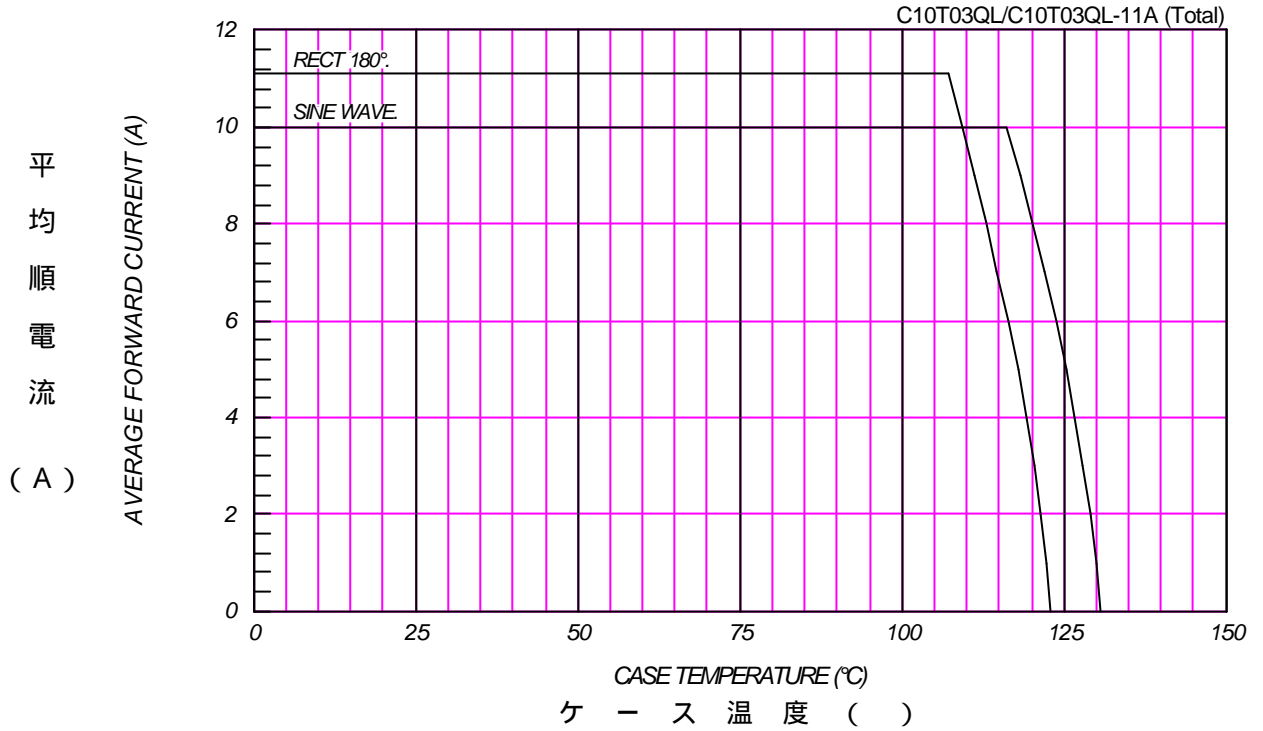

サージ順電流定格
SURGE CURRENT RATINGS

f=50Hz, Sine Wave, Non-Repetitive, No Load

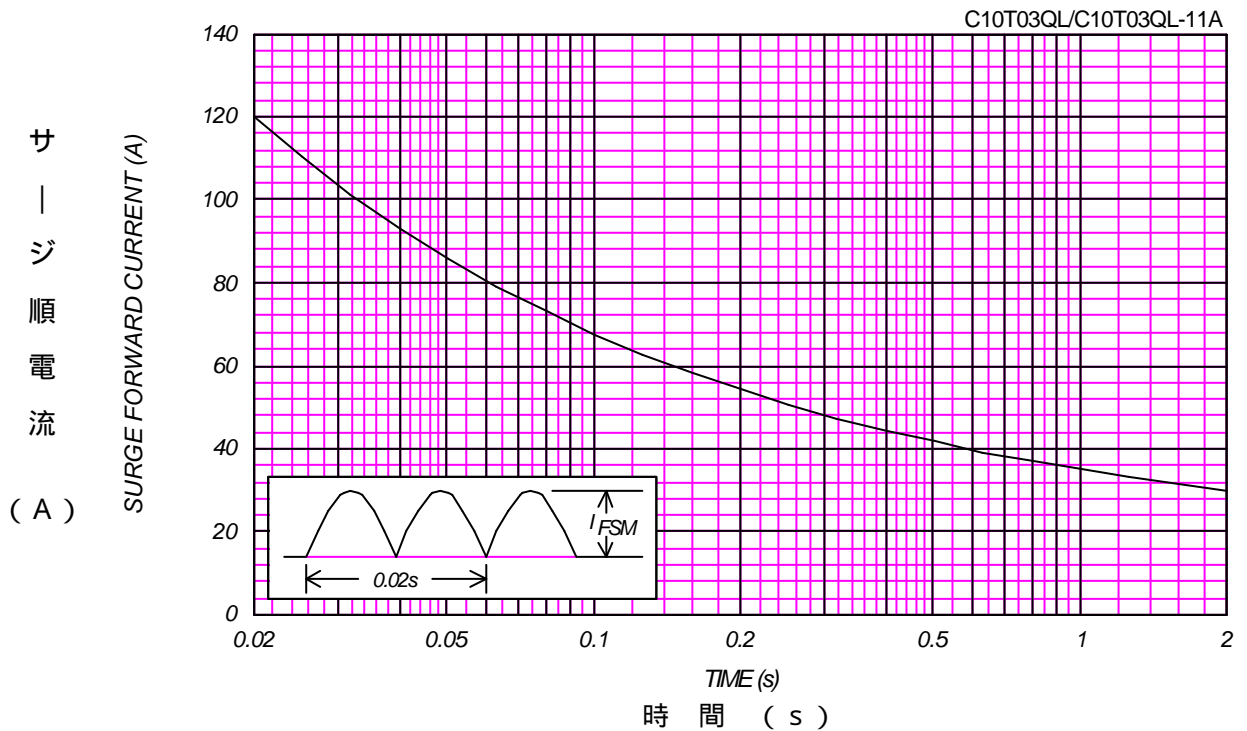

接合容量特性
JUNCTION CAPACITANCE VS. REVERSE VOLTAGE

T_j=25°C, V_m=20mV_{RMS}, f=100kHz, Typical Value

C10T03QL/C10T03QL-11A (per Arm)

